

# BERNINA 790 PRO

User Manual

made to create **BERNINA**



## Dear BERNINA customer,



Congratulations! You have decided on BERNINA and therefore on a product which will delight you for years. For more than 100 years our family company has attached greatest importance to satisfied customers. As for me, it is a matter of personal concern to offer you Swiss development and precision at the height of perfection, future-orientated sewing technology and a comprehensive customer service.

The BERNINA 7-series consists of various ultramodern machines, whose development not only focused the highest demands on technique and the ease of use but also considered the design of the product. After all we sell our products to creative people like you, who do not only appreciate high quality but also form and design.

Enjoy the creative sewing, embroidering and quilting on your new BERNINA 790 PRO and keep informed about the various accessories at [www.bernina.com](http://www.bernina.com). On our homepage you will also find a lot of inspiring sewing instructions, to be downloaded for free.

Our highly trained BERNINA dealers will provide you with more information on service and maintenance offers.

I wish you lots of pleasure and many creative hours with your new BERNINA.

H.P. Ueltschi

Owner

BERNINA International AG

CH-8266 Steckborn



# Table of Contents

<b>IMPORTANT SAFETY INSTRUCTIONS .....</b>	<b>10</b>	2.5 Spool Pin .....	37
<b>Important Information .....</b>	<b>13</b>	Swiveling Spool Pin .....	37
<b>1 My BERNINA .....</b>	<b>15</b>	Horizontal Spool Pin .....	38
1.1 Introduction .....	15	2.6 Feed Dog .....	39
1.2 BERNINA Quality Control .....	15	Adjusting the Feed Dog .....	39
1.3 Welcome to the World of BERNINA .....	15	2.7 Slide-on Table .....	39
1.4 Overview Machine .....	17	Using the Slide-on Table .....	39
Overview Front Controls .....	17	Using the Seam Guide .....	40
Overview Front .....	18	2.8 Presser Foot .....	40
Overview Sideways .....	19	Adjusting the Presser Foot Position via the Knee Lifter of the Free Hand System .....	40
Overview - Back Panel .....	20	Adjusting the Presser Foot Position via the Button «Presser Foot Up/Down» .....	40
1.5 Supplied Accessories .....	21	Changing the Presser Foot .....	40
Overview Accessories Machine .....	21	Selecting the Presser Foot in the User Interface .....	41
Overview Presser Feet .....	23	Setting the Presser Foot Pressure .....	41
Accessory Box .....	25	2.9 Adjusting the Feed Dog .....	41
1.6 Overview User Interface .....	26	2.10 Needle and Stitch Plate .....	42
Overview Functions/Visual Information .....	26	Changing the Needle .....	42
Overview System Settings .....	26	Selecting the Needle in the User Interface .....	42
Overview Selection Menu Sewing .....	27	Remembering Needle Type and Needle Size .....	42
Software Operation .....	27	Adjusting the Needle Position Up/Down .....	43
1.7 Needle, Thread, Fabric .....	29	Adjusting the Needle Position Left/Right .....	43
Overview Needles .....	29	Needle Stop Up/Down (Permanent) .....	43
Example for Needle Description .....	32	Changing the Stitch Plate .....	44
Thread Selection .....	33	Selecting the Stitch Plate in the User Interface .....	44
Needle/Thread Combination .....	33	Switching the Laser On/Off .....	44
<b>2 Sewing Preparation .....</b>	<b>34</b>	2.11 Threading .....	45
2.1 Before Using the Machine for the First Time .....	34	Threading the Upper Thread .....	45
2.2 Accessories Box .....	34	Threading the Twin Needle .....	46
Accessory Box Free Standing .....	34	Threading the Triple Needle .....	46
Storing Accessory .....	34	Winding the Bobbin Thread .....	47
2.3 Connection and Switching On .....	35	Threading the Bobbin Thread .....	48
Connecting the Foot Control .....	35	Indicating Fill Level of Bobbin Thread .....	50
Connecting the Machine .....	35	<b>3 Setup Program .....</b>	<b>51</b>
Attaching the Knee Lifter of the Free Hand System .....	36	3.1 Sewing Settings .....	51
Fixing the Touch Screen Pen .....	36	Adjusting the Upper Thread Tension .....	51
Switching the Machine On .....	36	Adjusting the Maximum Sewing Speed .....	51
2.4 Foot Control .....	37	Programming Securing Stitches .....	51
Regulating the Speed via the Foot Control .....	37	Adjusting the Hovering Height of the Presser Foot .....	51
Activate/Deactivate Additional Function .....	37	Programming the Button «Thread Cutter» .....	52
		Programming the Button «Quick Reverse» .....	52
		Programming the Button «Securing» .....	52
		Adjusting the Presser Foot Position with Needle Stop Down .....	53



Programming the Button «Pattern End» .....	53	5.3	Regulating the Speed .....	66
Programming the Foot Control .....	53	5.4	Adjusting the Upper Thread Tension .....	67
3.2	Embroidery Settings .....	54	5.5	Editing Stitch Patterns .....
Adjusting the Upper Thread Tension .....	54	Changing the Stitch Width .....	67	
Adjusting the Maximum Embroidering Speed .....	54	Changing the Stitch Length .....	68	
Adjusting the Thread Cut .....	54	Correcting the Balance .....	68	
Activating/Deactivating the Function Thread Away .....	55	Programming Pattern Repeat .....	68	
Calibrating the Embroidery Hoop .....	56	Programming Long Stitch .....	69	
Setting the Stitch Length .....	56	Mirror Image of Stitch Patterns .....	69	
Changing the Measuring Unit .....	56	Edit Stitch Pattern Length .....	69	
Enter the Fabric Thickness .....	57	Programming the Stitch Counter Function .....	69	
Programming the Securing Stitches .....	57	Sewing Stitch Patterns Using the Triple Stitch .....	70	
Centering or Opening Embroidery Designs in the Original Position .....	57	Quick Reverse .....	70	
3.3	Selecting Personal Settings .....	58	Permanent Quick Reverse .....	70
3.4	Monitoring Functions .....	58	Backstepping .....	70
Activating the Upper Thread Indicator .....	58	Changing the Sewing Direction .....	70	
Activating the Bobbin Thread Indicator .....	58	5.6	Combining Stitch Patterns .....	71
3.5	Activating the Audio Signals .....	58	Overview Combi Mode .....	71
3.6	Machine Settings .....	59	Overview Combi Mode Extended .....	71
Selecting a Language .....	59	Creating Stitch Pattern Combinations .....	71	
Adjusting the Brightness of the Display .....	59	Saving a Stitch Pattern Combination .....	72	
Adjusting the Sewing Light .....	59	Loading a Stitch Pattern Combination .....	72	
Calibrating the Display .....	60	Overwriting a Stitch Pattern Combination .....	72	
Back to Basic Setting .....	60	Deleting a Stitch Pattern Combination .....	72	
Deleting User Data .....	60	Editing the View of the Stitch Pattern Combination .....	73	
Deleting Designs on the BERNINA USB Stick .....	61	Editing a Single Stitch Pattern .....	73	
Calibrating the Buttonhole Foot #3A .....	61	Deleting a Single Stitch Pattern .....	73	
Packing the Embroidery Module .....	61	Adding a Single Stitch Pattern .....	74	
Reviewing the Total Number of Stitches .....	61	Relocating a Single Stitch Pattern .....	74	
Registering Details of the Dealer .....	62	Adapting the Stitch Pattern Length and Stitch Pattern Width .....	74	
Saving Service Data .....	62	Mirroring a Stitch Pattern Combination .....	75	
Display Machine ID .....	62	Stitch Pattern Combination Subdivider 1 .....	76	
Displaying the Machine Name .....	63	Stitch Pattern Combination Subdivider 2 .....	76	
Setting the WiFi Connection .....	63	Securing a Stitch Pattern Combination .....	76	
<b>4</b>	<b>System Settings .....</b>	<b>64</b>	Relocating Several Stitch Patterns .....	76
4.1	Calling Up the Tutorial .....	64	Programming Pattern Repeat .....	77
4.2	Calling Up the Creative Consultant .....	64	Changing the Sewing Direction of a Stitch Pattern .....	77
4.3	Calling up the Embroidery Consultant .....	64	Changing the Sewing Direction of a Stitch Pattern Combination .....	77
4.4	Calling Up the Help .....	64	5.7	Administering Stitch Patterns .....
4.5	Using eco Mode .....	64	Saving Settings of Stitch Patterns .....	77
4.6	Cancelling Any Alterations with «clr» .....	64	Calling Up the Previously Sewn Stitch Patterns .....	78
<b>5</b>	<b>Creative Sewing .....</b>	<b>65</b>	Saving Stitch Patterns in Personal Memory .....	78
5.1	Overview Selection Menu Sewing .....	65	Overwriting Stitch Patterns from the Personal Memory .....	78
Selecting a Stitch Pattern .....	65	Loading Stitch Patterns from the Personal Memory .....	78	
5.2	BERNINA Dual Feed .....	65	Deleting Stitch Patterns from the Personal Memory .....	78
Switching On/Off the BERNINA Dual Feed .....	66	Saving Stitch Patterns on the BERNINA USB Stick .....	79	
			Uploading a Stitch Pattern from the BERNINA USB Stick .....	79
			Deleting Stitch Patterns from the BERNINA USB Stick ..	79

5.8	Stitch Designer .....	80	<b>7</b>	<b>Decorative Stitches .....</b>	<b>100</b>
	Overview Stitch Designer .....	80	7.1	Overview Decorative Stitches .....	100
	Creating Your Own Stitch Pattern .....	80	7.2	Bobbin-Play .....	101
	Editing the View .....	81	7.3	Altering the Stitch Density .....	102
	Inserting Points .....	81	7.4	Tapering .....	103
	Relocating the Points .....	81		Overview Tapering .....	103
	Duplicating Points .....	81		Altering Points of a Stitch Pattern .....	103
	Deleting Points .....	82		Sewing Tapering .....	104
	Activating the Triple Stitch .....	82		Sewing tapering automatically .....	104
	Mirror Image of Stitch Patterns .....	82	7.5	Sewing Cross Stitches .....	105
	Reversing the Stitch Sequence .....	83	7.6	Pintucks .....	105
	Designing a Stitch Pattern from Scratch .....	83		Pintucks .....	105
	Determining the Stitch Pattern Width .....	83		Overview Pintuck Feet .....	106
5.9	Securing Stitches .....	83		Working with Cord .....	106
	Securing a Seam with the Button «Securing» .....	83		Sewing Pintucks .....	107
	Securing with the Button «Pattern End» .....	83	<b>8</b>	<b>Alphabets and Monograms .....</b>	<b>108</b>
5.10	Height Compensation of Uneven Layers .....	84	8.1	Overview Alphabets .....	108
5.11	Sewing Corners .....	84	8.2	Creating Lettering .....	109
<b>6</b>	<b>Practical Stitches .....</b>	<b>85</b>	8.3	Altering Font Size .....	109
6.1	Overview Practical Stitches .....	85	8.4	Altering Size of Monogram .....	110
6.2	Sewing Straight Stitch .....	88	<b>9</b>	<b>Buttonholes .....</b>	<b>111</b>
6.3	Securing with the Automatic Securing Program .....	88	9.1	Overview Buttonholes .....	111
6.4	Sewing in the Zipper .....	89	9.2	Making Use of the Height Compensation Tool .....	112
6.5	Sewing Both Sides of the Zipper from Bottom to Top .....	90	9.3	Using the Compensation Plate .....	113
6.6	Sewing Triple Straight Stitch .....	90	9.4	Marking Buttonholes .....	113
6.7	Sewing Triple Zigzag .....	91	9.5	Cord .....	114
6.8	Manual Darning .....	91		Using Cord with the Buttonhole Foot with Slide #3A ..	114
6.9	Automatic Darning .....	93		Using Cord with the Buttonhole Foot #3C .....	115
6.10	Reinforced Darning, Automatic .....	94	9.6	Sewing a Test Sample .....	116
6.11	Reinforced Darning .....	94	9.7	Determining the Buttonhole Slit Width .....	116
6.12	Finishing Edges .....	95	9.8	Determining the Buttonhole Length with the Buttonhole Foot with Slide #3A .....	117
6.13	Sewing Double Overlock .....	95	9.9	Determining the buttonhole length with Buttonhole Foot #3C .....	117
6.14	Narrow Edgestitching .....	96	9.10	Sewing a Buttonhole Automatically .....	118
6.15	Wide Edgestitching .....	96	9.11	Programming the Heirloom Buttonhole .....	118
6.16	Edgestitching Using the Seam Guide .....	96	9.12	Sewing the Manual 7-step Buttonhole .....	119
6.17	Sewing Hem Edges .....	97	9.13	Sewing the Manual 5-step Buttonhole .....	119
6.18	Sewing Blind Hems .....	97	9.14	Cutting the Buttonhole Open with the Seam Ripper .....	120
6.19	Sewing Visible Hems .....	98	9.15	Cutting Open Buttonholes with the Buttonhole Cutter (Optional Accessory) .....	121
6.20	Sewing Flat Joining Seams .....	99			
6.21	Sewing Basting Stitches .....	99			



9.16 Sewing on a Button .....	121	13.2 Preparing the Machine .....	136
9.17 Sewing Eyelets .....	122	Lowering the Feed Dog .....	136
<b>10 Quilting .....</b>	<b>123</b>	Selecting the Embroidery Design .....	137
10.1 Overview Quilt Stitches .....	123	13.3 Embroidery Foot .....	137
10.2 Quilting, Securing Program .....	124	Attaching the Embroidery Foot .....	137
10.3 Sewing Handlook Quilt Stitches .....	124	Selecting the Stitch Plate in the User Interface .....	137
10.4 Guiding the Quilt Work Freely .....	125	13.4 Needle and Stitch Plate .....	138
<b>11 BERNINA Stitch Regulator (BSR) .....</b>	<b>126</b>	Inserting the Embroidery Needle .....	138
11.1 BSR Mode 1 .....	126	Selecting the Embroidery Needle in the User Interface .....	138
11.2 BSR Mode 2 .....	126	Remembering Needle Type and Needle Size .....	139
11.3 BSR mode 3 .....	126	Attaching the Stitch Plate .....	139
11.4 BSR Function with Straight Stitch No. 1 .....	126	Selecting the Stitch Plate in the User Interface .....	140
11.5 BSR Function with Zigzag No. 2 .....	126	Thread-up Command .....	140
11.6 Sewing Preparations for Quilting .....	126	Switching the Laser On/Off .....	140
Attach the BSR Presser Foot .....	126	13.5 Embroidery Hoops .....	141
Changing the Presser Foot .....	127	Overview Embroidery Hoop Selection .....	141
11.7 Using the BSR Mode .....	127	Selecting the Embroidery Hoop .....	141
11.8 Securing Stitches .....	128	Tear-away Stabilizers .....	141
Securing in BSR1 Mode with the Button «Start/Stop» ..	128	Cut-away Stabilizers .....	141
Securing in BSR2 Mode .....	128	Using Adhesive Spray .....	141
11.9 Using the KickStart Function .....	128	Using Spray Starch .....	142
<b>12 My BERNINA Embroidery .....</b>	<b>130</b>	Using Iron-on Interfacing .....	142
12.1 Overview Embroidery Module .....	130	Using Paper-backed Adhesive Stabilizer .....	142
12.2 Supplied Accessories Embroidery Module .....	130	Using Water-soluble Stabilizer .....	142
Overview Accessory Embroidery Module .....	130	Preparing the Embroidery Hoop .....	142
12.3 Overview User Interface .....	131	Attaching the Hoop .....	143
Overview Functions/Visual Information .....	131	Overview Embroidery functions .....	144
Overview System Settings .....	132	Centering the Needle to the Embroidery Hoop .....	144
Overview Selection Menu Embroidery .....	132	Move Hoop to the Back .....	144
12.4 Important Embroidery Information .....	132	Moving the Module for the Sewing Mode .....	144
Upper Thread .....	132	Grid On/Off .....	144
Bobbin Thread .....	133	Locating the Center of the Embroidery Design .....	144
Selecting the Embroidery File Format .....	133	Virtual Positioning of the Embroidery Hoop .....	145
Embroidery Test .....	133	<b>14 Setup Program .....</b>	<b>146</b>
The Size of the Embroidery Design .....	133	14.1 Adjusting the Embroidery Settings in the Setup	
Embroidering Designs by Third-party Providers .....	134	Program .....	146
Underlay Stitches .....	134	<b>15 Creative Embroidering .....</b>	<b>147</b>
Satin or Leaf Stich .....	134	15.1 Overview Embroidering .....	147
Step Stitch .....	135	15.2 Selecting and Changing the Embroidery Design .....	147
Connecting Stitches .....	135	15.3 Checking the Embroidery Time and the Embroidery	
<b>13 Embroidery Preparation .....</b>	<b>136</b>	Design Size .....	147
13.1 Attaching the Module .....	136	15.4 Regulating the Speed .....	147
		15.5 Editing the Embroidery Design .....	148
		Overview Editing embroidery motif .....	148
		Scaling Up the Embroidery Design View .....	148
		Downsizing the Embroidery Design .....	148
		Moving the Embroidery Design View .....	149
		Moving the Embroidery Design in Enlarged View .....	149

Moving the Embroidery Design .....	149	15.11 Freearm Embroidery .....	171
Rotating the Embroidery Design .....	150	15.12 Administering Embroidery Designs .....	171
Altering the Embroidery Design Size Proportionally .....	150	Administering Embroidery Designs .....	171
Altering the Embroidery Design Size Disproportionally .....	150	Saving Embroidery Designs in the Personal Memory ....	172
Mirroring Embroidery Designs .....	151	Saving the Embroidery Design on the BERNINA USB	
Changing the Stitch Type .....	151	Stick .....	172
Altering the Stitch Density .....	152	Overwriting the Embroidery Design in the Personal	
Checking the Size and the Position of the Embroidery		Memory .....	172
Design .....	152	Overwriting the Embroidery Design on the BERNINA	
Endless Embroidery .....	153	USB Stick .....	172
Duplicating the Embroidery Design .....	154	Importing Stitch Patterns .....	173
Arranging Embroidery Designs .....	155	Loading an Embroidery Design from the Personal	
Deleting an Embroidery Design .....	155	Memory .....	173
Undoing Entries .....	156	Loading an Embroidery Design from the BERNINA USB	
15.6 Pinpoint Placement .....	156	Stick .....	173
Positioning the Embroidery Design with the help of 2		Deleting an Embroidery Design from the Personal	
Grid Points .....	156	Memory .....	174
Positioning the Embroidery Design by means of 2		Deleting an Embroidery Design from the BERNINA USB	
freely positioned Points .....	157	Stick .....	174
Placing an Embroidery Design into a Square in a		<b>16 Embroidery .....</b>	<b>175</b>
deformed Shape .....	158	16.1 Embroidering via the Button «Start/Stop» .....	175
Positioning the Embroidery Design proportionally in a		16.2 Increasing the Embroidery Speed .....	175
Square .....	159	16.3 Adjusting the Upper Thread Tension .....	175
15.7 Combining Embroidery Designs .....	159	16.4 Embroidering via the Foot Control .....	176
Combining Embroidery Designs .....	159	<b>17 Care and Maintenance .....</b>	<b>177</b>
Deleting a Single Embroidery Design .....	160	17.1 Firmware .....	177
Duplicating the Embroidery Design .....	160	Checking the Firmware Version .....	177
Duplicating a Combination .....	161	Updating Firmware .....	177
Grouping Embroidery Designs .....	161	Recovering Saved Data .....	177
Align the Embroidery Design .....	162	17.2 Machine .....	178
Changing the Sequence within an Embroidery Design		Cleaning the Display .....	178
Combination .....	163	Cleaning the Feed Dog .....	178
15.8 Creating Lettering .....	163	Cleaning the Hook .....	179
Overview Embroidery Alphabets .....	163	Lubricating the Hook .....	179
Creating Lettering .....	164	Cleaning the Thread Catcher .....	181
Editing a Single-Line Lettering .....	165	Clean the Needle Threader .....	181
Editing Multi-Line Lettering .....	165	<b>18 Errors and Faults .....</b>	<b>182</b>
15.9 Changing the Colors of the Embroidery Design .....	166	18.1 Error Messages .....	182
Overview Changing the Color .....	166	18.2 Troubleshooting .....	187
Changing the Colors .....	166	<b>19 Storage and Disposal .....</b>	<b>191</b>
Altering the Colors via the Color Wheel .....	166	19.1 Storing the Machine .....	191
Changing the Thread Brand .....	167	19.2 Dispose of the Machine .....	191
15.10 Embroidering the Embroidery Design .....	168	<b>20 Technical Data .....</b>	<b>192</b>
Overview Selection Menu Embroidering .....	168	<b>21 Overview Stitch Patterns .....</b>	<b>193</b>
Adding Basting Stitches .....	168		
Moving the Hoop .....	168		
Embroidery Sequence Control When Thread Breaks ....	168		
Activating Quilting Settings .....	169		
Reducing Color Changes .....	169		
Multi-colored Embroidery Design On/Off .....	169		
Endless Embroidery .....	169		
Color Indication .....	170		





21.1	Overview Stitch Patterns .....	193
	Practical Stitches .....	193
	Buttonholes .....	193
	Decorative Stitches .....	193
	Quilt Stitches .....	198
21.2	Overview Embroidery Desings .....	198
	Editing the Embroidery Design .....	198
	Projects .....	199
	Quilt Designs .....	201
	Embellishment .....	207
	Flowers .....	211
	Children .....	214
	Animals .....	218
	Borders and Lace .....	221
	Mini .....	223
	Sayings .....	225
	Sport and Hobbies .....	228
	Hoop .....	229
	Seasons .....	231
	Charming monograms .....	235
	Modern Monograms .....	238
	Letters .....	241
	DesignWorks .....	246
	<b>Index .....</b>	<b>248</b>



# IMPORTANT SAFETY INSTRUCTIONS

Please be aware of the following basic safety instructions when using your machine. Before using this machine, read instruction manual carefully.

## DANGER

To protect against electric shock, the following instructions must be observed.

- Never leave the machine unattended when it is connected to the power supply.
- Immediately after use and before cleaning, switch off the machine and disconnect the power cable from the outlet.

In order to protect against injury, the following instructions must be adhered to.

- Do not look directly into the laser beam or view it with optical instruments (e.g. magnifying glasses).
- If the laser is damaged or defective, have the laser checked or repaired by your nearest BERNINA dealer.
- Do not look directly into the LED lamp with optical instruments (e. g. magnifying glass).
- If the LED lamp is damaged or defective, have the LED lamp checked or repaired at your local authorized BERNINA dealer.
- Switch off the machine before working in the needle area.
- Before starting the machine, close all covers.

## WARNING

To reduce the risk of burns, fire, electric shock or injury to persons, the following instructions must be observed.

### General Facts

- This machine may only be used for the purpose described in this instruction manual.

### Working Environment

- Do not use the machine outdoors.
- Only use the machine in dry rooms.
- Do not use the machine in a humid area.
- Do not use the machine in rooms where aerosol products (sprays) are being used.
- Do not use the machine in rooms where oxygen is dispensed.

### Technical Condition

- Never use the machine when it is damp.
- Do not use the machine if it is not working properly.
- Do not use the machine if a cable or the plug is damaged.
- Do not use the machine if it has been dropped, damaged or has fallen into water.
- If the machine is damaged or does not work properly, have the machine checked or repaired by your local authorized BERNINA dealer.
- Keep all ventilation openings of the machine and the foot control free of lint, dust and loose cloth.
- Do not use the machine if the ventilation openings are blocked.

### Accessories and Supplies

- Only use the accessories recommended by the manufacturer.
- Always use the original BERNINA Stitch Plate.  
An incorrect stitch plate can result in needle breakage.
- Use only straight needles of good quality.  
Bent or damaged needles can cause needle breakage.



- This machine is double-insulated (except for USA, Canada and Japan). Use only identical replacement parts. See instructions for Servicing of double-insulated products.
- To lubricate the machine, only use oil recommended by BERNINA.

### Safety Instructions

- While operating the machine, all protective inserts must be in place and all covers must be closed.

### Appropriate Use

- The machine may be used, cleaned and maintained by children older than eight or by people with reduced physical, sensory or mental capabilities or if there is a lack of experience and knowledge as long as they have been given instructions.
- Furthermore, these persons must be supervised while working with the machine, and/or they must know the safe operation of the machine and be aware of the resulting hazards.
- Children are not allowed to play with the system.
- Special care should be taken when the machine is operated by or in the presence of children.
- Only use the machine with the supplied power cable.
- USA and Canada only: Do not connect power plug NEMA 1-15 to circuits exceeding 150 volt-to-ground.
- Only use this machine with the supplied foot control of type LV-1.
- Do not insert any objects into the openings of the machine.
- Do not place any objects on the foot control.
- While sewing, guide the fabric gently. Pulling and pushing the fabric can cause needle breakage.
- Keep fingers away from all moving parts.

- Special care is required in the needle area.
- For activities in the needle area - such as threading the needle, changing the needle, threading the looper or changing the presser foot - switch off the machine.
- To switch off, set the power switch to «0».
- When protective covers are removed, when the machine is oiled or when other cleaning and maintenance operations mentioned in this instruction manual are carried out, switch off the machine and disconnect the power plug from the outlet.
- Pull the plug out of the outlet by pulling on the plug. Do not pull on the cable.

## Safety Signs on the Machine

Sign	Purpose
<p><b>ATTENTION</b> Pièces en rotation! Pour réduire les risques de blessure, Déconnecter avant toute opération d'entretien.</p> <p><b>CAUTION</b> Moving Parts! To reduce risk of injury, Switch off before servicing.</p>	<p>Caution; moving parts.</p> <p>To reduce the risk of injury, switch off the machine before maintenance work.</p>
<p><b>LASER 2</b></p> <p>NEC 49051-1-1114 (ANSI Z39.1) PHOTO</p>	<p>Warning against laser radiation in the needle area</p> <p>Laser classification 2 - Laser radiation - Do not look into the beam.</p> <p>Wavelength: 650 nm</p> <p>Power rating: &lt;1 mW</p>

## FCC Declaration of Conformity

(For USA and Canada)

**Responsible company:** BERNINA International AG, Seestrasse 161, 8266 Steckborn, SCHWEIZ

**Product name:** BERNINA 790 PRO

This device complies with the terms of paragraph 15 of the U.S. Federal Communications Commission (FCC) regulations. Operation of this device is subject to the following conditions: (1) The device must not cause harmful interference, and (2) the device must be able to withstand harmful interference, including interference that may cause undesired operation.

This device has been tested and found to comply with the limits for a Class B digital device, pursuant to the specifications in paragraph 15 of the FCC Rules. These specifications define adequate protection against this type of interference in enclosed rooms. This device can generate, use and radiate RF energy. Therefore, if not installed and used properly, it may cause harmful interference to radio communications. However, there is no specific guarantee that interference may not occur in certain cases. If this device does cause harmful interference to radio or television reception, which can be determined by turning the device off and on, the user is encouraged to try to correct the interference by one or more of the following measures:

- Reorient the antenna or set it up at a different location.
- Increase the spacing between the equipment and receiver.
- Connect the equipment into an outlet on a circuit different from that to which the receiver is connected.
- Contact your BERNINA dealer or an experienced radio/television technician.

Any changes or modifications to the device not explicitly approved by BERNINA may invalidate the electromagnetic compatibility (EMC) and result in the withdrawal of the operating license for this device.



## Important Information

### Availability of the Instruction Manual

The instruction manual is supplied with the machine.



- Keep the instruction manual safe at a suitable place near the machine to have it at hand in case that you need to look up something.
- If you pass the machine to a third party, always include the instruction manual.
- The latest version of the instruction manual can be downloaded at [www.bernina.com](http://www.bernina.com)

### Proper Use

Your BERNINA machine is conceived and designed for private household use. It is intended for sewing fabrics and other materials as described in this instruction manual. Any other use is not considered proper. BERNINA assumes no liability for consequences resulting from improper use.


### Equipment and Scope of Delivery

Example images are used in these instructions for the purposes of illustration. The machines shown in the images and the accessories shown therefore do not always match the actual items included with your machine. The supplied accessory can vary depending on the country of delivery. You can acquire any accessories mentioned or shown that are not included in the scope of delivery as optional accessories from a specialist BERNINA dealer. Further accessories can be found at [www.bernina.com](http://www.bernina.com).

For technical reasons and in order to improve the product, changes may be made to the equipment of the machine and the scope of delivery at any time and without prior notice.

### Servicing of Double-insulated Products

In a double-insulated product two systems of insulation are provided instead of grounding. No grounding means is provided on a double-insulated product nor should a means for grounded be added to the product. Servicing a double-insulated product requires extreme care and knowledge of the system and should only be done by qualified service personnel. Replacement parts for a double-insulated product must be identical to the original parts in the product. A double insulated product is marked with the words: «Double-Insulation» or «double-insulated».

 The symbol may also be marked on the product.

### Environmental Protection

BERNINA International AG is committed to environmental protection. We strive to minimize the environmental impact of our products by continuously improving product design and our technology of manufacturing.



The machine is labeled with the symbol of the crossed-out wastebin. This means that the machine should not be disposed of in household waste when it is no longer needed. Improper disposal can result in dangerous substances getting into the groundwater and thus into our food chain, damaging our health.

The machine must be returned free of charge to a nearby collection point for waste electrical and electronic equipment or to a collection point for the reuse of the machine. Information on the collection points can be obtained from your local administration. When purchasing a new machine, the dealer is obliged to take back the old machine free of charge and dispose of it properly.

If the machine contains personal data, you are responsible for deleting the data yourself before returning the machine.

## Explanation of Symbols

 DANGER

Designates a danger with a high risk which can lead to serious injuries or even death unless it is avoided.

 WARNING

Designates a medium-risk hazard which can lead to serious injuries if not avoided.

 CAUTION

Designates a low-risk hazard which can lead to minor or moderate injuries if not avoided.

NOTICE

Designates a hazard which can lead to material damage if not avoided.



**Tips** from BERNINA **sewing experts** are found next to this symbol.



# 1 My BERNINA

## 1.1 Introduction

The purposes of your BERNINA 790 PRO are sewing, embroidering and quilting. Delicate silk or satin fabrics as well as heavyweight linen, fleece and denim can be sewn without any problems with this machine. Numerous practical as well as decorative stitches, buttonholes and embroidery designs are at your disposal.

In addition to this instruction manual, following Help Programs are provided at any time to give you useful advice and support how to operate your BERNINA 790 PRO.

The **Tutorial** gives information and explanations about various aspects of sewing and embroidering as well as the different stitches.

The **Creative Consultant** informs you about decision support for sewing projects. After entering the kind of fabric and the desired sewing project, suggestions concerning the suitable needle or the appropriate presser foot are displayed.

The **Embroidery Consultant** informs you about decision support for embroidery projects. After entering the desired embroidery project and the fabric, suggestions for the suitable needle and the suitable embroidery foot are displayed.

The **Help Program** provides information about individual stitch patterns, functions and operations in the user interface.

### Further Information



In addition to this instruction manual for your BERNINA 790 PRO, further informative print media are enclosed.

The current version of your manual as well as many other information about the machine and the accessories can be found on our website <https://www.bernina.com>

## 1.2 BERNINA Quality Control

All BERNINA machines are assembled with utmost care and are subjected to an extensive functionality test. The integrated stitch counter therefore indicates that the machine has already sewn stitches, which were performed exclusively for test purposes and quality control. The subsequent thorough cleaning does not exclude the possibility that thread remnants may still be found in the machine.

## 1.3 Welcome to the World of BERNINA

Made to create, this is the slogan of BERNINA. Not only with our machines do we support you in the implementation of your ideas. In addition to the offers listed below, we offer you lots of suggestions and instructions for your future projects as well as the opportunity to exchange ideas with other sewing, quilting and embroidery enthusiasts. We wish you lots of pleasure.

### BERNINA YouTube channel



On YouTube we offer a wide range of how-to videos and support concerning the most important functions of our machines. You can also find detailed explanations many presser feet, meaning that your projects will be a complete success.

[www.youtube.com/BerninaInternational](http://www.youtube.com/BerninaInternational)

Available in English and German.

### «inspiration» - the creative sewing magazine and online store with cutting patterns



Are you looking for ideas, sewing patterns and instructions for great sewing projects? In this case, the BERNINA magazine «inspiration» is exactly what you need. Three times a year, inspiration offers fantastic sewing and embroidery ideas. From seasonal fashion trends to trendy accessories and practical tips to original decorations for your home or cute sewing ideas for children.

The magazine is available in English, German, Dutch, and French.

In our online shop you can purchase “inspiration” as an e-magazine or as a print version, either as individual issues or as a subscription. Furthermore, there are many individual downloadable cutting patterns to discover! Why not take a look at [inspiration.bernina.com](http://inspiration.bernina.com) and follow us on Instagram ([inspiration.sewing.magazin](https://www.instagram.com/inspiration.sewing.magazin)).

### BERNINA Blog



Subtle instructions, free cutting patterns and embroidery designs as well as many new ideas: All this you can find in the weekly blog of BERNINA. Our experts give useful tips and explain step by step how you can achieve the desired result. In the community you can upload your own projects and exchange experiences and ideas with other sewing and embroidering enthusiasts.

[www.bernina.com/blog](http://www.bernina.com/blog)

Available in English, German, Dutch and French.

### BERNINA Social Media



Follow on social networks to learn more about events, thrilling projects as well as tips and tricks all about sewing, quilting and embroidering. We will keep you informed and we are looking forward to presenting you the one or the other highlight from the world of BERNINA.

[www.bernina.com/social-media](http://www.bernina.com/social-media)

### BERNINA World App



Download the BERNINA App from the App Store to your smartphone and enjoy direct access to all product information. The accessory organizer gives you an overview of your accessories and those you still would like to have. Furthermore, you have direct access to the customer portal, the blog and the “inspiration” online store, and you can always find an authorized specialist dealer near you. The app is available in the Apple App Store and the Google Play Store. You will find direct links at: [www.bernina.com/app](http://www.bernina.com/app)

### BERNINA Stitchout App



WiFi enabled BERNINA embroidery machines can be used together with the BERNINA Stitchout App. Once the machine is connected to the app, the embroidery process can be tracked and monitored via the smartphone. The app shows how far the embroidery design has progressed, which color will be next and how long the embroidery process will take in total. Furthermore, messages are displayed for the case that the thread is broken or the embroidery is finished. The app is available in the Apple App Store and the Google Play Store. You will find direct links at: [www.bernina.com/stitchout-app](http://www.bernina.com/stitchout-app)





## 1.4 Overview Machine

### Overview Front Controls



- |   |                        |    |                              |
|---|------------------------|----|------------------------------|
| 1 | «Quick Reverse»        | 7  | «Automatic Needle Threader»  |
| 2 | «Thread Cutter»        | 8  | «Securing Stitches»          |
| 3 | «Presser Foot Up/Down» | 9  | «Needle position Up/Down»    |
| 4 | «Start/Stop»           | 10 | «Upper Multi-function Knob»  |
| 5 | Speed Control          | 11 | «Lower Multi-function Knob»  |
| 6 | «Pattern End»          | 12 | «Needle Position Right/Left» |

## Overview Front



- |   |                                  |    |                                 |
|---|----------------------------------|----|---------------------------------|
| 1 | Connection for Embroidery Module | 6  | Thread Take-up Lever Cover      |
| 2 | Bobbin Cover                     | 7  | Thread Take-up Lever            |
| 3 | Presser Foot                     | 8  | Fixing Screw                    |
| 4 | Needle Threader                  | 9  | Connection for Slide-on Table   |
| 5 | Sewing Light                     | 10 | Connection for Free Hand System |

## Overview Sideways



- |   |                                       |    |                                     |
|---|---------------------------------------|----|-------------------------------------|
| 1 | Connection for Foot Control           | 8  | Power Switch                        |
| 2 | Service Connection                    | 9  | Connection for Power Cable          |
| 3 | Connection for Accessory              | 10 | Magnetic Holder for Touchscreen Pen |
| 4 | Horizontal Spool Pin                  | 11 | Air Vents                           |
| 5 | Bobbin Unit Switch with Thread Cutter | 12 | USB Port                            |
| 6 | Swiveling Spool Pin                   | 13 | Feed Dog Up/Down                    |
| 7 | Handwheel                             |    |                                     |

## Overview - Back Panel



- |   |                               |    |                          |
|---|-------------------------------|----|--------------------------|
| 1 | Connection for Slide-on Table | 8  | Carry Handle             |
| 2 | Connection for Darning Hoop   | 9  | Bobbin Winder Pretension |
| 3 | BSR Connection                | 10 | Thread Guide             |
| 4 | Connection for Accessory      | 11 | BDF BERNINA Dual Feed    |
| 5 | Air Vents                     | 12 | Thread Cutter            |
| 6 | Thread Guide                  | 13 | Feed Dog                 |
| 7 | Bobbin Winding Unit           | 14 | Stitch Plate             |

## 1.5 Supplied Accessories



You will find further information and application tips on the supplied and optional accessories at:  
[www.bernina.com/790-pro#!accessories](http://www.bernina.com/790-pro#!accessories)

### Overview Accessories Machine






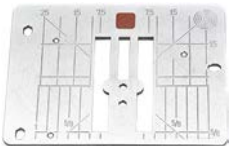



Illustration	Name	Purpose
	Dust Cover	To protect the machine from dust and contamination.
	BERNINA Accessories Box	To store the supplied accessories as well as optional accessories.
	Free Hand System (FHS)	To raise and lower the presser foot.
	Slide-on Table	To increase the sewing surface.
	Seam Guide for Slide-On Table	To support wide topstitching of edges.
	Straight and CutWork Stitch Plate	To sew straight stitches and for CutWork.
	Spool Cap	To support the regular unwinding of the thread from the spool.
	Bobbin for B9 Hook Set of 5	To wind the bobbin thread.
	Foam Pad 2 pieces	The foam pad prevents the thread from slipping, tangling or breaking on the spool pin.













Illustration	Name	Purpose
	Touchscreen Pen	For precise operation of the touch screen.
	Seam Ripper	To undo seams and to cut buttonholes open.
	Height Compensating Tool	To level an angled position of the presser foot sole when sliding over thick seams.
	Needle Assortment	For any common applications.
	Right Seam Guide	To align regular seam distances.
	Screwdriver Torx, gray	To change the needle.
	Screwdriver red (slot)	To loosen and tighten slotted screws.
	Angular Torx wrench Torx	To open the headframe.
	Brush/Needle Inserter	To clean the feed dog and the looper area.
	Sewing Machine Oil	To oil the machine.
	Power Cable	To connect the machine with the power supply system.

Illustration	Name	Purpose
	Foot Control	To start and stop the machine. To control the sewing speed.

## Overview Presser Feet

### Supplied Standard Presser Feet






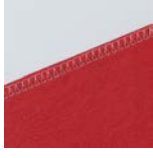





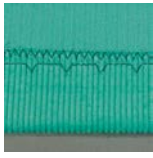








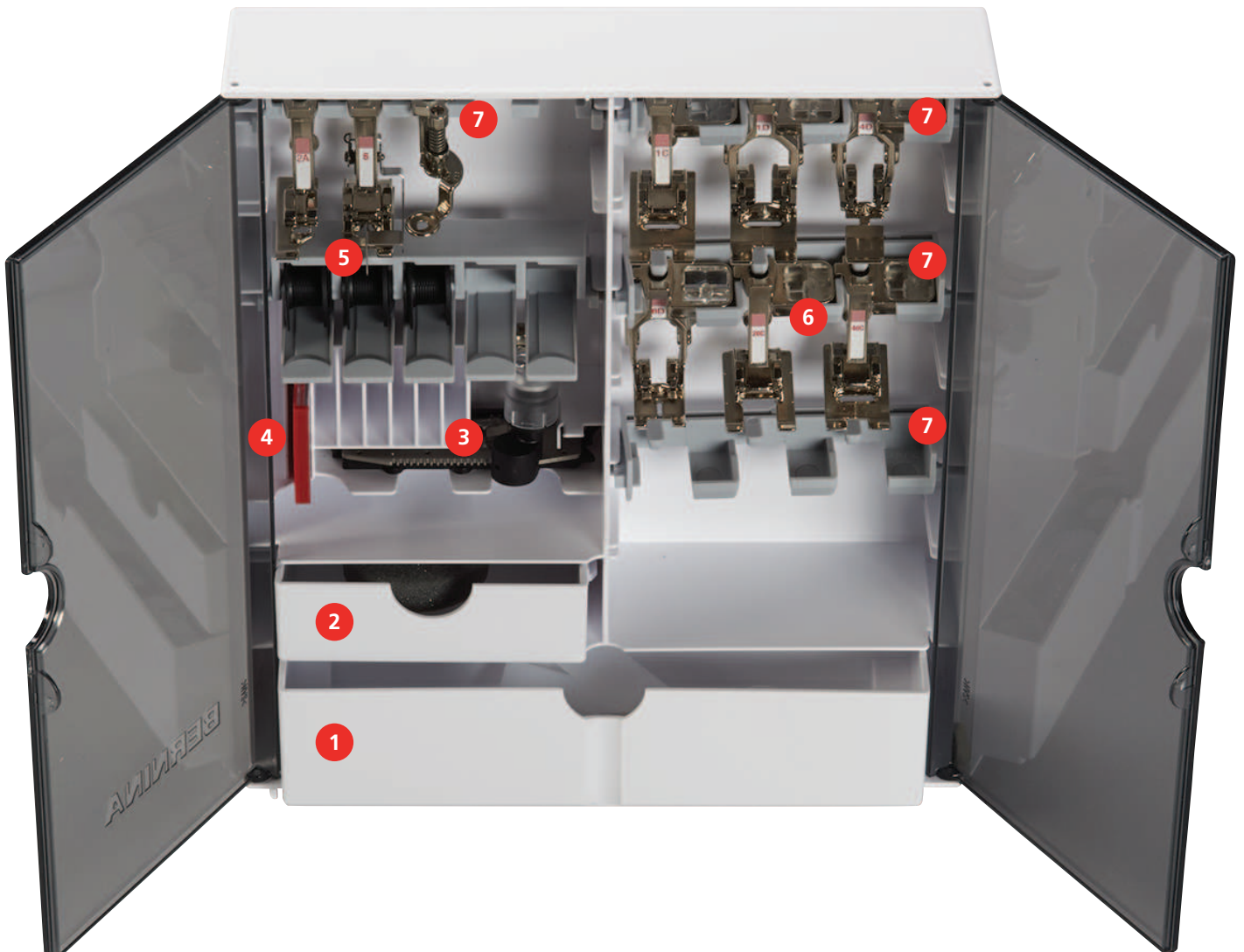
Illustration	Number	Name	Purpose	Example
	#1C	Reverse Pattern Foot	For sewing different practical and decorative stitches. To sew forward and in reverse.	
	#1D	Reverse Pattern Foot	For sewing different practical and decorative stitches. To sew forward and in reverse.	
	#2A	Overlock Foot	To finish edges in stretch material.	
	#3A	Buttonhole Foot with Slide	To sew buttonholes automatically.	
	#4D	Zipper Foot	For sewing in zippers.	
	#5	Blindstitch Foot	For sewing blind-stitch hems. For stitching edges guided on the left side of the presser foot.	

Illustration	Number	Name	Purpose	Example
	#8D	Jeans Foot	For sewing with Dual Feed. To sew denim.	
	#20C	Open Embroidery Foot	For sewing applications and decorative patterns.	
	#40C	Sideways-Motion Foot	For sewing sideways motion patterns.	
	#42	BERNINA Stitch Regulator (BSR)	Free-motion quilting with regular stitch length.	



## Accessory Box

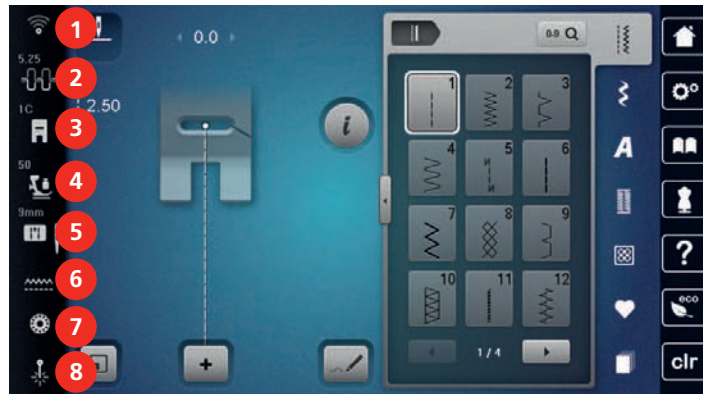
In the accessory box, accessories can be neatly stored in compartments and matching holders.



- |   |                            |   |   |
|---|----------------------------|---|---|
| 1 | Big drawer                 | 5 | Spool Pin                                       |
| 2 | Small drawer               | 6 | Presser Feet                                    |
| 3 | Buttonhole foot with slide | 7 | Presser Foot Holders for 5.5 mm and 9.0 mm feet |
| 4 | Selection of needles       |   |   |

## 1.6 Overview User Interface

### Overview Functions/Visual Information



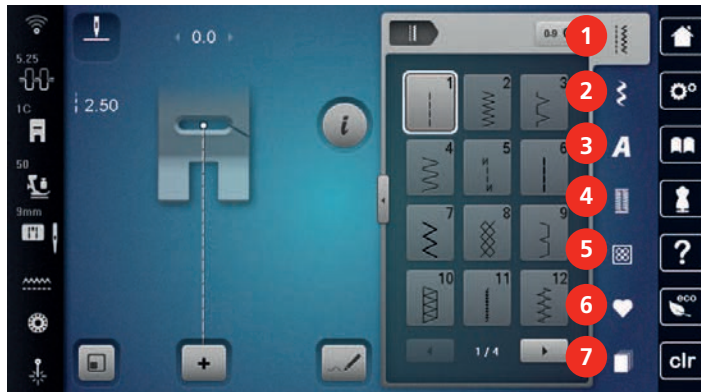
- |   |   |   |                                 |
|---|---|---|---------------------------------|
| 1 | «WiFi»  | 5 | «Stitch Plate/Needle Selection» |
| 2 | «Upper Thread Tension»                          | 6 | «Feed Dog Indicator»            |
| 3 | «Presser Foot Indicator/Presser Foot Selection» | 7 | «Bobbin Thread»                 |
| 4 | «Presser Foot Pressure»                         | 8 | «Laser»                         |

### Overview System Settings



- |   |                       |   |                  |
|---|-----------------------|---|------------------|
| 1 | «Home»                | 5 | «Help»           |
| 2 | «Setup Program»       | 6 | «eco Mode»       |
| 3 | «Tutorial»            | 7 | «Clear Settings» |
| 4 | «Creative Consultant» |   |                  |

## Overview Selection Menu Sewing



- |   |                       |   |                   |
|---|-----------------------|---|-------------------|
| 1 | «Practical Stitches»  | 5 | «Quilt Stitches»  |
| 2 | «Decorative Stitches» | 6 | «Personal Memory» |
| 3 | «Alphabets»           | 7 | «History»         |
| 4 | «Buttonholes»         |   |                   |

## Software Operation

The touch-sensitive display can be operated with the finger or touchpen.

**Tap:** Short tap of an element.





**Swipe:** Tap an element and swipe quickly on the display.

**Draw:** Tap the display and slowly move in one direction, eg. for scrolling up and down.


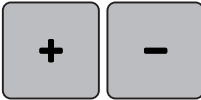

### Navigation

Illustration	Name	Purpose
	«Home»	Show Home screen.
	Navigation Path	Show a previous menu level.
	«Close»	Close the window.
	More	Show more features or information.
	Continue	Scroll to next display.
	Back	Scroll to previous display.

### Activate/Deactivate Functions

Illustration	Element	Status
	Switch	Function is activated.
		Function is deactivated.
	Icon	Function is deactivated.
		Function is activated.

### Adjust Values

Illustration	Name	Purpose
	Slider Control	Set the value with the slider control. Reset the value to the default value by tapping the small bullet.
	Field «Plus» / «Minus»	«Plus» increase, «Minus» reduce the value.
	Yellow Frame	Indication that the set value differs from the default value. Reset the value to the default value by tapping.

### Enter Text and Numbers

To enter numerical values or text, a corresponding keyboard is shown.











Illustration	Name	Purpose
	Entry Field	Display of the entry. Delete all characters entered with a single tap.
	«Deleting»	Delete the last character.

Illustration	Name	Purpose
	«Lower Case Characters»	Show the available letters in lower case letters.
	«Upper Case Characters»	Show the available letters in upper case letters.
	«Numbers and Mathematical Characters»	Show the available numbers and mathematical characters.
	«Special Characters»	Show the available special characters.
	«Confirm»	Confirm the entry and leave the submenu.
	«Cancel»	Cancel the entry and the view closes.

## 1.7 Needle, Thread, Fabric

Needles will wear down over time. Therefore, the needle should be replaced regularly. Only a perfect point results in a good stitching result. In general, the thinner the fabric, the finer the needle. The illustrated needles are either standard or optional accessory, depending on the machine.

- Needle sizes 70, 75: for light-weight fabrics.
- Needle sizes 80, 90: for medium fabrics.
- Needle sizes 100, 110 and 120: for heavy fabrics.

### Overview Needles





Illustration	Needle Name	Needle Description	Purpose
 	<b>Universal Needle</b> 130/705 H 60/8 – 120/19	With a slightly rounded point.	For woven fabrics (light, medium, heavy-weight), knitwear, leather, plastic, jeans/denim. For natural and synthetic fabrics.  For general sewing, sewing on buttons and buttonholes, zippers, hems and topstitching, decorative sewing, embroidery, patchwork, quilting.
 	<b>Stretch Needle</b> 130/705 H-S 75/11 – 90/14	With a medium ball point.	For knitwear (jersey, tricot, knit and stretch material).  For general sewing, sewing on buttons and buttonholes, zippers, hems and topstitching, decorative sewing, embroidery.

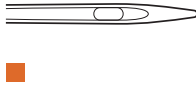
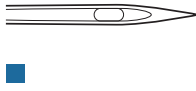
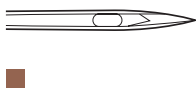
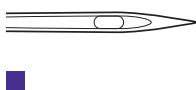
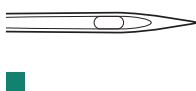
Illustration	Needle Name	Needle Description	Purpose
	<b>Jersey/Embroidery Needle</b> 130/705 H SUK 80/12	With a medium ball point.	For woven fabrics (light, medium, heavy-weight), knitwear, plastic.  For general sewing, sewing on buttons and buttonholes, zippers, hems and topstitching, decorative sewing, embroidery.
	<b>Jeans Needle</b> 130/705 H-J 80/12 – 110/18	With slim, particularly acute point.	Woven fabrics (light, medium, heavy-weight), leather, jeans/denim.  For general sewing, sewing on buttons and buttonholes, zippers, hems and topstitching, decorative sewing, embroidery, patchwork, quilting.
	<b>Leather Needle</b> 130/705 H LR 90/14, 100/16	With a cutting point (LR = special point to sew leather).	For leather, imitation leather and other similar materials.  For zippers, hems and topstitching, materials that tend to stick.
	<b>Microtex Needle</b> 130/705 H-M 60/8 – 110/18	With a particularly pointed and slender tip.	For woven fabrics (light, medium, heavy), artificial materials and materials that are difficult to work with. For silk, microfibre fabrics, foils, coated and hard-sliding materials.  For sewing in general, sewing on buttons and buttonholes, zips, hems and topstitching and decorative sewing. For ultra straight stitches when topstitching edges.
	<b>Quilting Needle</b> 130/705 H-Q 75/11 – 90/14	With a very slim, slightly rounded point.	For woven fabrics (light, medium and heavy-weight).  Decorative sewing, patchwork, quilting. For stitching/topstitching tasks, such as quilting and patchwork.

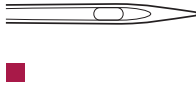
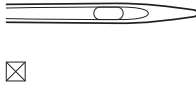
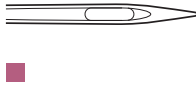
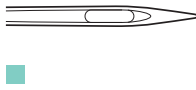
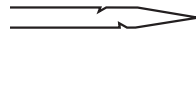
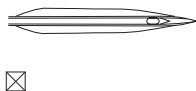




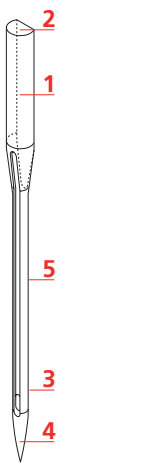
Illustration	Needle Name	Needle Description	Purpose
	<b>Embroidery Needle</b> 130/705 H-E 75/11 – 90/14	With a light ball point and a particularly wide eye and wide groove.	For woven fabrics (light, medium, heavy-weight), knitwear. For voluminous and woolen threads.  For general sewing, sewing on buttons and buttonholes, zippers, hems and topstitching, decorative sewing, embroidery.
	<b>Fine Fabrics Needle</b> 130/705 H SES 70/10 – 90/14	With a light ball point.	For fine, delicate materials, such as velvet.  For general sewing, sewing on buttons and buttonholes, zippers, hems and topstitching, decorative sewing, embroidery, patchwork, quilting.
	<b>Metafil Needle</b> 130/705 H METAFIL 80/12	With medium ball point and long eye (2 mm).	For woven fabrics (light, medium, heavy-weight), knitwear. For sewing with special effects and fancy threads, especially metallic threads.  For embroidery with metallic thread. For hems and topstitching, decorative sewing and embroidery.
	<b>Topstitch Needle</b> 130/705 H-N 80/12 – 100/16	With medium ball point and long eye (2 mm).	For woven fabrics (light, medium and heavy-weight).  For hems and topstitching, decorative sewing and embroidery. For decorative and quilting work with several sewing threads and also for embroidery.
	<b>Felting Needle</b> PUNCH	With small barbs.	For woven fabrics (light, medium, heavy-weight), jeans/denim.  For felting a variety of yarns and threads into base fabrics.
	<b>Hemstitch Needle</b> 130/705 H WING 100/16, 120/20	With a «wing» on each side of the needle blade.	For woven fabrics (light, medium and heavy-weight).  For special effects with hemstitch embroidery.

Illustration	Needle Name	Needle Description	Purpose
 ☒	<b>Universal Twin Needle</b> 130/705 H ZWI 70-100	Needle distance: 1.0/1.6/2.0/2.5/3.0/4.0/ 6.0/8.0	For visible hems in stretch fabrics, pintucks, decorative sewing.
 ☒	<b>Stretch Twin Needle</b> 130/705 H-S ZWI 75	Needle distance: 2.5/4.0	For visible hems in stretch fabrics, pintucks, decorative sewing.
 ☒	<b>Hemstitch Twin Needle</b> 130/705 H ZWIHO 100	Needle distance: 2.5	For special effects with hemstitch embroidery.
 ☒	<b>Universal Triple Needle</b> 130/705 H DRI 80	Needle distance: 3.0	For visible hems in stretch fabrics, decorative sewing.

### Example for Needle Description

The 130/705 system, which is the most common for household machines, is explained by the following picture of a Jersey/Stretch needle.

	<p><b>130/705 H-S/70</b></p> <p><b>130</b> = Shank length (1)</p> <p><b>705</b> = Flat shank (2)</p> <p><b>H</b> = Needle scarf (3)</p> <p><b>S</b> = Needle point (here medium ball point) (4)</p> <p><b>70</b> = Needle size 0.7 mm (5)</p>
---	---





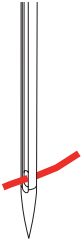
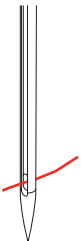
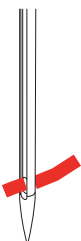
## Thread Selection

For a perfect sewing result, thread and fabric quality play an important role.

We recommend purchasing quality threads to achieve good sewing results.

- Cotton threads have the advantage of being a natural fiber and therefore are especially suitable for sewing cotton fabrics.
- Mercerized cotton threads have a slight sheen that is not lost with washing.
- Polyester threads have a high tensile strength and is particularly colorfast.
- Polyester threads are more flexible and are recommended where a strong and elastic seam is required.
- Rayon threads are made of natural fibers and have a brilliant sheen.
- Rayon threads are suitable for decorative stitches and achieve a more beautiful effect.

## Needle/Thread Combination

	<p>The needle/thread combination is correct, when the thread fits perfectly into the long groove and goes easily through the needle eye. The thread can be optimally sewn.</p>
	<p>The thread can break and skipped stitches can occur when there is too much clearance in the long groove and the needle eye.</p>
	<p>The thread can break and get stuck when the thread scrapes against the edge of the long groove not fit well into the needle eye optimally.</p>

## 2 Sewing Preparation

### 2.1 Before Using the Machine for the First Time



BERNINA recommends lubricating the hook before using the machine for the first time or after a longer period of non-use. (see page 177)

By oiling the hook, the occurrence of unwanted noises in the hook area can be avoided.

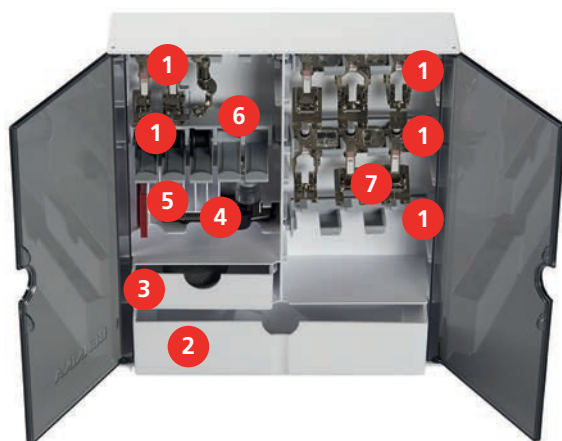
### 2.2 Accessories Box

#### Accessory Box Free Standing

> On the back of the box, pull both extensions out until they click into place.



#### Storing Accessory



- > Insert the holders (1) for bobbins, presser feet and needles into the accessory box.
- > Store the presser feet in the holders (7) (5.5 mm or 9.0 mm).
- > Store the small parts, e.g. thread discs etc., in the drawers (2) and (3).
- > Buttonhole Foot with Slide #3A in compartment (4).
- > Store the provided needle package in the special compartment (5).

#### NOTICE

#### Scratched Sensor Surfaces of the Bobbin

Malfunction of the lower thread indicator. If the sensor surfaces of the bobbins are scratched or dirty, the bobbin thread indicator will no longer detect the low thread level.

- > Always position the bobbins in the bobbin holder with the silver sensor surface to the right.
- > Position the bobbins in the bobbin holder (6) with the silver sensor surface to the right.
- > To remove a bobbin, press the compartment holder down.

## 2.3 Connection and Switching On

### Connecting the Foot Control

- > Unwind the cable of the foot control to the desired length and clamp it in the cable clamps.



- > Insert the plug of the cable into the foot control socket of the machine.



- > Place the foot control under the table.
- > If the cable is too long, roll up the excess length and fix it in the cable clamps.

### Connecting the Machine

To ensure safe operation of the machine, only the supplied mains cable may be used. The supplied power cable is designed for the voltage range applicable in the country of use. If the machine is to be used in a country other than the country of origin, the power cable suitable for that country must be obtained from the Authorized BERNINA dealer.

The power cable for the USA and Canada has a polarized power plug (one contact is wider than the other). To reduce the risk of an electric shock, the plug can only be inserted into the socket in one way. If the power plug does not fit in the socket, reverse then insert the power plug. If the reversed power plug still does not fit, an electrician must install an appropriate socket. Do not modify the power plug in any way.

- > Insert the device connector of the power cable into the machine's power cable connection.



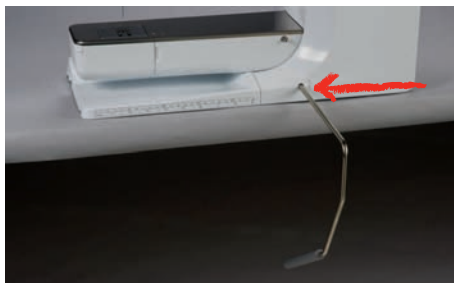
- > Insert the power plug of the power cable into the socket.

## Attaching the Knee Lifter of the Free Hand System



The lateral position of the lever can be adjusted by your local BERNINA Dealer required.

- > Insert the knee lifter into the opening at the front side of the machine.
- > Adjust the sitting height so that the knee lifter can be operated with the knee.



## Fixing the Touch Screen Pen

- > Store the touchscreen pen at the magnet holder.



## Switching the Machine On

- > Set the power switch to «I».



## 2.4 Foot Control

### Regulating the Speed via the Foot Control

Via the foot control the speed can be adjusted infinitely variable.

- > Press the foot control down carefully to start the machine.
- > To sew faster, press the foot control harder.
- > Release the foot control to stop the machine.



### Activate/Deactivate Additional Function

The Foot Control can be programmed with a second function that can be activated and deactivated by a Back-kick. On delivery, the Back-kick is programmed with the function «Needle Up/Down».

- > To raise or lower the needle, press the foot control downward with your heel.



The Back-kick function can be programmed individually. (see page 53)

## 2.5 Spool Pin

### Swiveling Spool Pin

Installing the spool holder



With metallic or other special threads, it is recommend to use the swiveling spool pin.

The swiveling spool holder is necessary when several threads are sewn and it can also be used for bobbin winding while sewing.

- > Swivel the spool holder up as far as it will go.



#### Inserting foam pad and thread spool

The foam pad prevents the thread from getting hooked at the swiveling spool holder.

- > Place the foam pad on the swiveling spool holder.
- > Place the thread spool on the spool holder.



#### Horizontal Spool Pin

##### Placing the Foam Pad, the Thread Spool and the Spool Cap

Spool caps hold the thread spool in place for proper release of thread from the spool. The spool cap is only used with the horizontal spool holder.

- > Place the foam pad on the spool pin.
- > Place the thread spool on the spool pin.
- > Position the appropriate spool cap on the spool pin so that there is no space between the spool cap and the thread spool.



#### Using the Spool Net

The spool net holds the thread on the thread spool and prevents the thread from knotting and breaking. The spool net is only used with the horizontal spool holder.



- > Pull the spool net over the thread spool. Ensure when doing so that the spool net does not slip off the thread spool, e.g. double-insert the net over the thread spools or insert a part of the net into the thread spool at the rear.



## 2.6 Feed Dog

### Adjusting the Feed Dog

- > To lower the feed dog, push the button «Feed Dog Up/Down».



- > To raise the feed dog, push the button «Feed Dog Up/Down» again.

## 2.7 Slide-on Table

### Using the Slide-on Table

The Slide-on Freearm Extension Table, attached to the freearm, enables the available sewing area to be extended.

- > Raise the needle.
- > Raise the presser foot.
- > Push the Slide-on Freearm Extension Table from the left to the right over the freearm until it engages.



- > To remove the Slide-on Freearm Extension Table, press the button at the table down and pull the slide-on table over the free arm to the left.



## Using the Seam Guide

The seam guide for the slide-on table facilitates sewing of evenly wide edges and hems.

Prerequisite:

- The slide-on table has been fitted.
- > Touch the release button and engage the seam guide from the front to the back on the slide-on table.

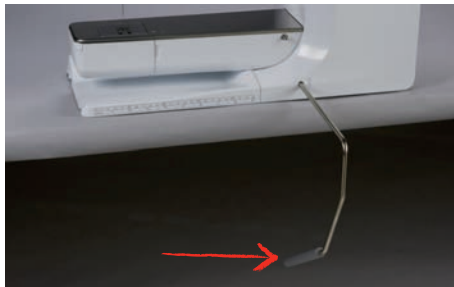


- > To determine the edge width, press the release button and move the seam guide to the right or left.
- > Touch the release button and pull the seam guide away to the front.

## 2.8 Presser Foot

### Adjusting the Presser Foot Position via the Knee Lifter of the Free Hand System

- > Adjust the sitting height so that the knee lifter can be operated with the knee.
- > Push the knee lifter with the knee to the right to raise the presser foot.



- Simultaneously the feed dog is lowered and the thread tension is released.
- > Release the knee lifter slowly to lower the presser foot.

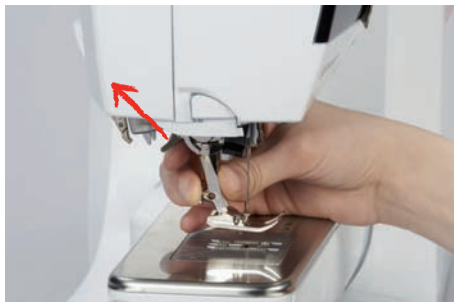
### Adjusting the Presser Foot Position via the Button «Presser Foot Up/Down»



- > To raise the presser foot, push the button «Presser Foot Up/Down».
- > To lower the presser foot, push the button «Presser Foot Up/Down» again.

### Changing the Presser Foot

- > Raise the needle.
- > Raise the presser foot.
- > Switch off the machine.
- > Push the clamping lever up.



- > Remove the presser foot.
- > Guide the new presser foot upwards over the cone.
- > Press the clamping lever down.



## Selecting the Presser Foot in the User Interface

After changing the presser foot, a check can be performed to determine whether it is suitable for the selected stitch pattern. Additionally, alternative presser feet are displayed, which are available for the selected stitch pattern.

- > Switch the machine on.
- > Select the stitch pattern.
- > Tap «Presser Foot Indicator/Presser Foot Selection».



- > To display all suitable presser feet for the selected stitch pattern, tap «Optional Presser Feet».



- > Select the attached presser foot.
  - When the selected presser foot is suitable, sewing can start.
  - If the selected presser foot is not suitable for the selected stitch pattern, it can still be selected but the machine is automatically prevented from starting. An error message is displayed. If an incorrect presser foot is selected, the sewing stitch is displayed in red in the sewing stitch preview.



## Setting the Presser Foot Pressure



The presser foot pressure is designed to adjust the pressure of the presser foot optimally to the fabric thickness. When working with thick fabrics, it is recommended to reduce the presser foot pressure. This provides the advantage that the fabric can be moved more easily. When the presser foot pressure is set below 0, the presser foot even lifts to give more space to the thick fabric. When working with thin fabrics, it is recommended to increase the presser foot pressure. This provides the advantage that the fabric cannot be moved too easily under the presser foot.



- > Tap «Presser Foot Pressure».
- > Adjust the presser foot pressure.

## 2.9 Adjusting the Feed Dog



- > Tap «Feed Dog Indicator».
- > Raise or lower the feed dog according to the animation.

## 2.10 Needle and Stitch Plate

### Changing the Needle

- > Raise the needle.
- > Switch off the machine.
- > Remove the presser foot.
- > Loosen the Fixing Screw of the needle using the Screwdriver (Torx, gray).



- > Pull the needle down.
- > Hold the new needle with the flat side to the back.
- > Insert the needle as far as it will go.
- > Tighten the Fixing Screw with the Screwdriver.

### Selecting the Needle in the User Interface

After changing the needle, you can check whether this can be used with the selected stitch plate.



- > Tap «Needle Selection».
- > Select the fitted needle.



- When the selected needle matches the selected presser foot, sewing can be started. If the selected needle does not match the selected presser foot, there will be an error message when starting the machine and the machine will not sew.

### Remembering Needle Type and Needle Size

Convenient memory function: To prevent a loss of information, the needle type and the needle size can be saved additionally on the machine. The saved needle type and the saved needle size can be checked at any time.



- > Tap «Needle Selection».



- > Tap «Needle Information».
- > Select the needle type (1) of the fitted needle.

- > Select the needle type (2) of the fitted needle.



### Adjusting the Needle Position Up/Down

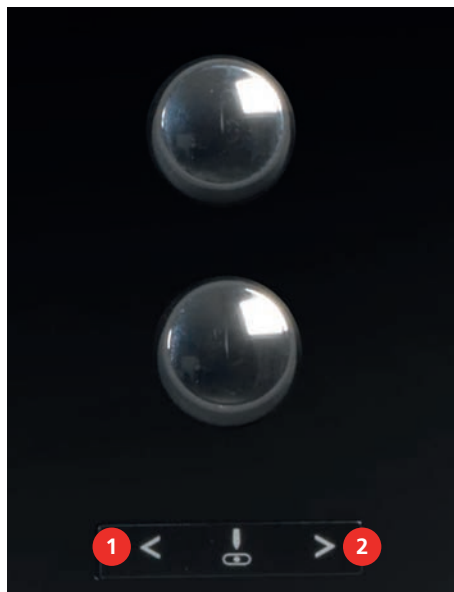


- > To lower the needle, push the button «Needle position Up/Down».
- > To raise the needle, push the button «Needle position Up/Down» again.

### Adjusting the Needle Position Left/Right

There is a total of 11 needle positions. The needle position is indicated by the needle position number in the display.

- > To position the needle position to the left, push the button «Needle Position Left» (1).
- > To position the needle position to the right, push the button «Needle Position Right» (2).



### Needle Stop Up/Down (Permanent)



- > To set the needle stop position permanently, tap «Needle Stop Up/Down».
  - The machine stops with needle position down as soon as the foot control is released or the button «Start/Stop» has been pushed.
- > Tap «Needle Stop Up/Down» again.
  - The machine stops with needle position up as soon as the foot control is released or the button «Start/Stop» has been pushed.

## Changing the Stitch Plate

The stitch plate is marked with vertical, horizontal and diagonal lines in millimeters (mm) and inches (inch). These markings are helpful for sewing or precise top-stitching.

- > Lower the feed dog.
- > Switch off the machine.
- > Remove the needle and presser foot.
- > Press the stitch plate down at the marking at the back on the right until it tilts.



- > Remove the stitch plate.
- > Place the openings of the new stitch plate above the corresponding guide pins and press down until it clicks into place.

## Selecting the Stitch Plate in the User Interface

After changing the stitch plate, you can check whether this can be used with the selected needle.



- > Tap «Stitch Plate Selection».
- > Select the previously fitted stitch plate.



- If the selected stitch plate is suitable to be used in combination with the needle, sewing can begin.
- If the selected stitch plate is not suitable to be used in combination with the needle, an error message is displayed and starting the machine is automatically prevented.

## Switching the Laser On/Off

The laser can be used to indicate the exact needle entry point.

Prerequisite:

- The needle is raised.



- > To activate the laser, tap «Laser».
  - The entry point is displayed. Depending on the presser foot and needle position, the entry point may be concealed by the presser foot.
- > To avoid the deflection of the laser with transparent presser feet, lower the presser foot before the sewing start, e.g. with the knee lifter.
- > To switch off the laser, tap the field highlighted in yellow «Laser».

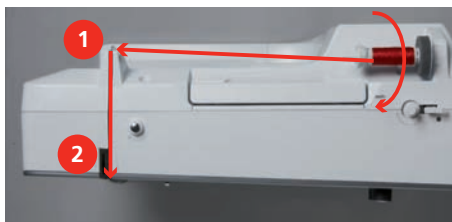
## 2.11 Threading

### Threading the Upper Thread

From a needle size of 70, the upper thread can be automatically threaded into standard sewing needles and embroidery needles.

Prerequisite:

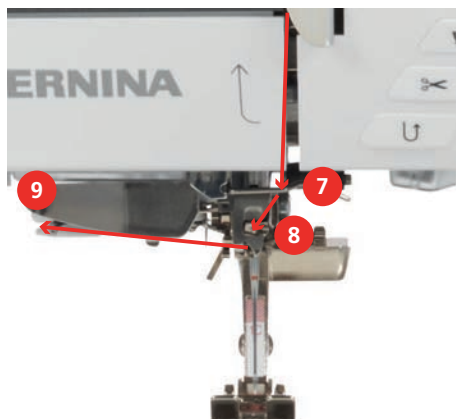
- The needle and the presser foot are raised.
- The machine is switched off.
- > Place the foam pad on the spool pin.
- > Place the thread spool on the spool pin so that the thread unwinds clockwise.
- > Attach the appropriate spool cap.
- > Guide the thread in direction of the arrow through the rear thread guide (1) and hold the thread with the hands so that it is taut and can be inserted into the thread tension.
- > Guide the thread in direction of the arrow through the thread tension (2).



- > Guide the thread downwards (3) around the thread take-up lever cover (4).
- > Guide the thread upwards and insert into the thread take-up lever (5).
- > Guide the thread downwards again (6).



- > Guide the thread through the guides (7/8) above the presser foot.



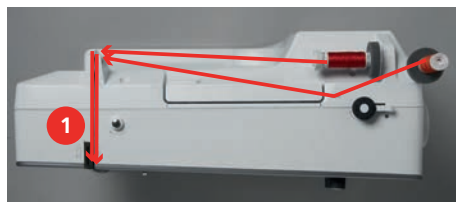
- > Guide the thread into the thread clamp (9) and pull it from the back to the front over the thread cutter.
- > Switch the machine on.
- > Push the button «Automatic Needle Threader».
  - The thread is threaded into the needle.



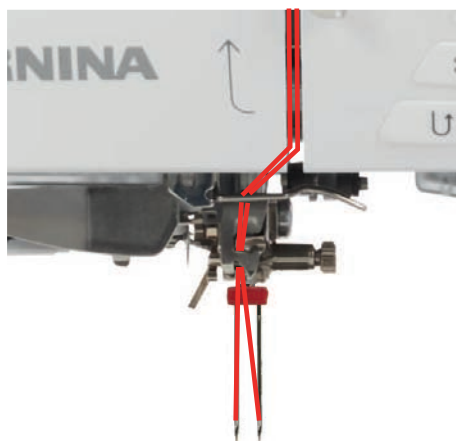
### Threading the Twin Needle

Prerequisite:

- The twin needle is inserted.
- > Guide the first thread in direction of the arrow on the right side of the tension disc (1).
- > Guide the second thread in direction of the arrow on the left side of the tension disc (1).



- > Guide the first and the second thread to the thread guide above the needle.
- > Thread the first thread manually into the right needle.
- > Thread the second thread manually into the left needle.



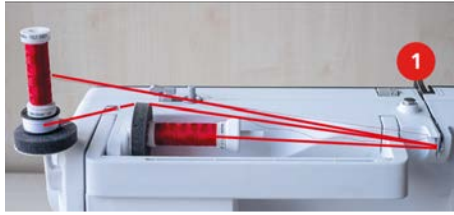
### Threading the Triple Needle

Prerequisite:

- The triple needle is inserted.
- > Place the foam pad, the thread spool and the appropriate spool cap on the horizontal spool pin.
- > Place the foam pad on the vertical spool pin.



- > Attach the filled bobbin on the vertical spool pin so that the silvery sensor surface is down.
- > Attach the thread spool in the opposite direction to the bobbin.
- > Thread the 3 threads up to the upper thread guide.



- > Guide 2 threads (vertical spool pin) past the thread tension disc (1) on the left and up to the thread guide above the needle.
- > Guide 1 thread (horizontal spool pin) past the thread tension disc (1) on the right and up to the thread guide above the needle.
- > Thread 1 thread of the vertical thread spool pin into the left and right needle by hand.
- > Thread the thread of the horizontal spool pin into the center needle manually.

### Winding the Bobbin Thread



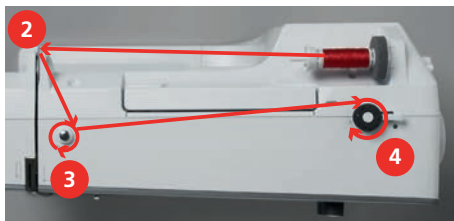
The bobbin thread can be wound while embroidering if the swiveling spool holder is used for winding.

Prerequisite:

- The foam pad, the thread spool and the appropriate spool cap are fitted.
- > Place the empty bobbin on the winding unit (1) so that the silver sensor surfaces are facing downwards.



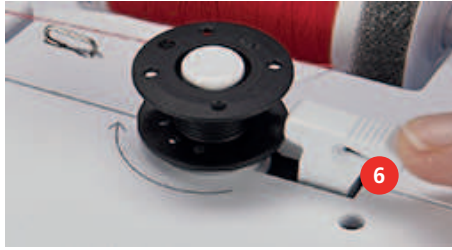
- > Guide the thread to the left into the rear thread guide (2).
- > Guide the thread around the bobbin winder pretension clockwise (3).
- > Wind the thread clockwise 2 – 3 times around the empty bobbin (4).



- > Pull the excess thread over the thread cutter at the engaging lever (5) and cut.



- > Push the engaging lever (6) against the bobbin.

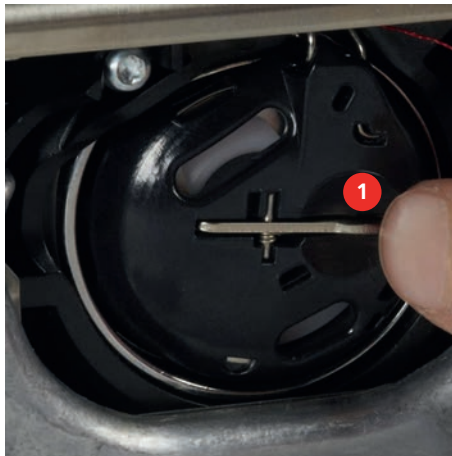


- The machine winds and the display to wind the bobbin appears.
- > Set winding speed.
- > To stop the winding process, push the engaging lever to the right.
- > To continue the winding process, push the engaging lever against the bobbin again.
  - As soon as the bobbin is full, the machine stops the winding process automatically.
- > Remove the bobbin and cut the thread using the thread cutter at the engaging lever.

### Threading the Bobbin Thread

Prerequisite:

- The needle is raised.
- The machine is switched off and the bobbin cover is opened.
- > Press the bobbin case release at the bobbin case (1).



- > Remove the bobbin case.
- > Remove the bobbin from the bobbin case.
- > Insert the new bobbin so that the silvery sensor surface is facing the back of the bobbin case.





- > Pull the thread into the slot (2) from the left.



- > Pull the thread to the right under the spring (3), then pass it below the two thread guides (4) and pull it upwards.



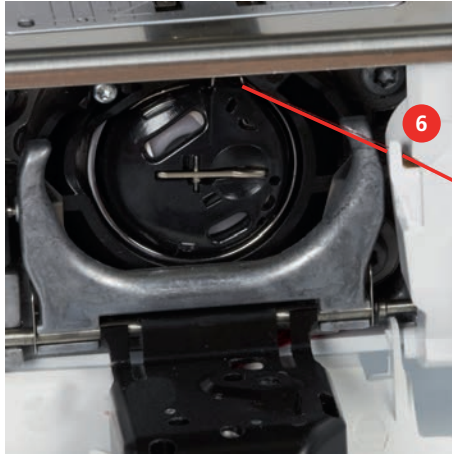
- > To insert the bobbin case into the machine, hold it so that the thread guide (5) points upwards.



- > Insert the bobbin case.
- > Press onto the center of the bobbin case until it engages.



- > Pull the thread through the thread cutter (6) and cut.



- > Close the looper cover.

### Indicating Fill Level of Bobbin Thread

When the fill level of the bobbin thread is low, an animation appears in the icon «Bobbin Thread» to indicate that the bobbin thread is about to run out.



- > To thread the bobbin thread according to the animation, tap, «Bobbin Thread».



## 3 Setup Program

### 3.1 Sewing Settings

#### Adjusting the Upper Thread Tension

Changes to the upper thread tension in the Setup Program affect all of the stitch patterns. The setting in the setup is retained after the machine is switched off.



> Tap «Setup Program».



> Tap «Sewing Settings».



> Tap «Adjusting the Upper Thread Tension».  
> Adjust the upper thread tension.

#### Adjusting the Maximum Sewing Speed

The maximum speed can be reduced by this function.



> Tap «Setup Program».



> Tap «Sewing Settings».



> Tap «Maximum Sewing Speed».  
> Set the maximum sewing speed.

#### Programming Securing Stitches

If the function is switched on, 4 securing stitches are automatically sewn at the start of the pattern after the thread cut.



> Tap «Setup Program».



> Tap «Sewing Settings».



> Switch «Securing Stitches at the Start of the Pattern» on or off.

#### Adjusting the Hovering Height of the Presser Foot

The hovering height of the presser foot can be adjusted according to the fabric thickness from 0 to maximal 7 mm.

Set hovering height = fabric thickness + required clearance between the fabric and the presser foot in the floating position.



> Tap «Setup Program».



> Tap «Sewing Settings».



> Tap «Programming Buttons and Icons».












> Tap «Programming the Hovering Height of the Presser Foot».  
> Adjust the distance between the fabric and the presser foot.









### Programming the Button «Thread Cutter»

The automatic securing can be programmed before the thread cut takes place.

-  > Tap «Setup Program».
-  > Tap «Sewing Settings».
-  > Tap «Programming Buttons and Icons».
-  > Tap «Programming the Button Thread Cutter».
-  > To activate the automatic securing, tap «Securing Stitches».
-  > To deactivate automatic securing, tap «Securing Stitches» again.
-  > To program subsequent securing stitches, tap «Securing Stitches in Close Succession».
-  > To program the number of securing stitches, tap «Minus» or «Plus».
-  > To program 4 securing stitches in place, tap «Securing Stitches in Place».







### Programming the Button «Quick Reverse»

It can be either chosen «Reverse Sewing» or «Backstepping».

-  > Tap «Setup Program».
-  > Tap «Sewing Settings».
-  > Tap «Programming Buttons and Icons».
-  > Tap «Programming the Button Quick Reverse».
-  > To set the stitch-precise reverse sewing, tap «Back Stepping».
-  > To set the reverse sewing, tap «Permanent Reverse Sewing».

### Programming the Button «Securing»






The number and type of securing stitches can be programmed.

-  > Tap «Setup Program».
-  > Tap «Sewing Settings».
-  > Tap «Programming Buttons and Icons».
-  > Tap «Programming the Button Securing».
-  > To program subsequent securing stitches, tap «Securing Stitches in Close Succession».
-  > To program the number of securing stitches, tap «Minus» or «Plus».

- > To program 4 securing stitches in place, tap «Securing Stitches in Place».










### Adjusting the Presser Foot Position with Needle Stop Down

With lowered needle, 3 different presser foot position can be selected: the presser foot lowered, the presser foot is raised to hovering position and the presser foot is raised to its maximum height.

-  > Tap «Setup Program».
-  > Tap «Sewing Settings».
-  > Tap «Programming Buttons and Icons».
-  > Tap «Pressure Foot Position with Needle Stop Down».
-  > Select the desired presser foot position.



### Programming the Button «Pattern End»









The presser foot can be positioned, the thread cut and the automatic securing can be programmed.

-  > Tap «Setup Program».
-  > Tap «Sewing Settings».
-  > Tap «Programming Buttons and Icons».
-  > Tap «Programming the Button Pattern End».
-  > To activate the automatic securing, tap «Securing Stitches».
-  > To deactivate automatic securing, tap «Securing Stitches» again.
-  > To program subsequent securing stitches, tap «Securing Stitches in Close Succession».
-  > To program the number of subsequent securing stitches, tap «Plus» or «Minus».
-  > To program 4 securing stitches in place, tap «Securing Stitches in Place».
-  > To deactivate the automatic thread cut after securing, tap «Automatic Thread Cutter».
-  > To activate the automatic thread cut after securing, tap «Automatic Thread Cutter» again.
-  > To keep the presser foot in lowered position, tap «Raise the Presser Foot».
-  > To raise the presser foot after securing, tap «Raise the Presser Foot» again.

### Programming the Foot Control

If «Needle Up/Down» is activated, the needle is raised or lowered with the back-kick on the foot control. Alternatively, the presser foot can be positioned, the thread can be cut and the automatic securing can be programmed.




-  > Tap «Setup Program».
-  > Tap «Sewing Settings».

-  > Tap «Programming the Foot Control».
- 
  - «Needle Up/Down» is activated in the default setting.
  - The back-kick on the foot control raises or lowers the needle.
-  > To program the Back-kick, tap «Programming the Back-kick».
- 
  - > To deactivate the automatic securing via the Back-kick, tap «Securing Stitches».
  - > To activate the automatic securing via the Back-kick, tap «Securing Stitches» again.
- 
  - > To program subsequent securing stitches, tap «Securing Stitches in Close Succession».
  - > To program the number of securing stitches, tap «Minus» or «Plus».
-  > To program 4 securing stitches in place, tap «Securing Stitches in Place».
- 
  - > To deactivate the automatic thread cut via the Back-kick, tap «Automatic Thread Cutter».
  - > To activate the automatic thread cut via the Back-kick, tap «Automatic Thread Cutter» again.
- 
  - > To keep the lowered position of the presser foot via the Back-kick, tap «Raise the Presser Foot».
  - > To keep the raised position of the presser foot via the Back-kick, tap «Raise the Presser Foot» again.

## 3.2 Embroidery Settings




### Adjusting the Upper Thread Tension

Changes to the upper thread tension in the Setup Program affect all of the embroidery designs.

-  > Tap «Setup Program».
-  > Tap «Embroidery Settings».
- 
  - > Tap «Adjusting the Upper Thread Tension».
  - > Adjust the upper thread tension.

### Adjusting the Maximum Embroidering Speed

The maximum speed can be reduced by this function.

-  > Tap «Setup Program».
-  > Tap «Embroidery Settings».
- 
  - > Tap «Maximum Embroidery Speed».
  - > Set the maximum sewing speed.

### Adjusting the Thread Cut

The settings for the thread cut can be customized. Deactivate the thread cut before changing the thread (2), or adjust the length of the connecting stitch (1). The machine does the cutting of the connecting threads at the determined length for you. First, set the length from which the connecting stitches are cut, and then select the embroidery design.



The length of the connecting thread can be set from 1 to 15 mm, the default setting is 6 mm. This means that all connecting stitches longer than 6 mm are cut automatically. If the value is reduced to 1 mm, more thread cuts are carried out, it takes longer to embroider and more loose thread ends can be seen on the wrong side of the fabric, especially when the function 'Thread-away' is activated too. On the right side of the fabric there will be practically none or merely very short connecting stitches which results in a wonderful stitch formation. Reducing the length of the thread cut to 1 mm is particularly of advantage when embroidering texts where usually many short connecting threads occur. If both sides of the stitch pattern are visible, it may be useful not to reduce the length of the thread cut too much to avoid having too many loose threads on the wrong side that get stitched in place during the process of embroidering and are then difficult to remove.



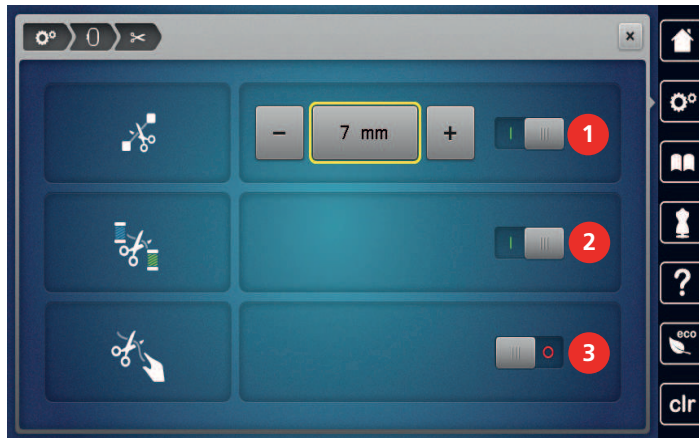
> Tap «Setup Program».



> Tap «Embroidery Settings».



> Tap «Thread Cut Settings».



- > To set the length at which the connecting stitches are cut, tap «Minus» or «Plus» (1) or deactivate automatic thread cut for connecting stitches.
- > To activate/deactivate the automatic thread cut before a thread change, tap the switch in the upper section of the display (2).
- > To make the machine stop after approx. 7 stitches so that the remaining thread can be cut by hand, touch the switch in the middle section of the display (3).

### Activating/Deactivating the Function Thread Away

To bring up the thread end after cutting and to pull it out of the fabric, the function must be activated. For embroidery motifs with long stitches it is recommended to deactivate the function Thread Away. If the distance between the presser foot and the embroidery hoop is too small, the function will not be carried out.



> Tap «Setup Program».



> Tap «Embroidery Settings».



> Tap «Thread Away».



> Activating/Deactivating the function thread away.

## Calibrating the Embroidery Hoop

The calibration of the embroidery hoop is the coordination of the needle to the center of the embroidery hoop.

Prerequisite:

- The embroidery module is connected and the embroidery hoop with the appropriate embroidery template is attached.



- > Tap «Setup Program».



- > Tap «Embroidery Settings».



- > Tap «Calibrating the Embroidery Hoop».
  - The machine recognizes the embroidery hoop automatically.
- > To delete the current calibration, tap «Deleting» (1).
- > Center the needle via the arrow icons on the display. For the precise positioning of the needle, the laser (2) can be switched on.



- > To save the calibration, tap «Confirm».

## Setting the Stitch Length

The set stitch length (stitches per inch) is used when embroidering quilt patterns, even if the quilt pattern has been changed in size.



- > Tap «Setup Program».



- > Tap «Embroidery Settings».



- > Tap «Stitch Length».
- > Set the stitch length.

## Changing the Measuring Unit

The measuring unit in the Embroidery Mode can be changed from mm to inch. The standard setting is in mm.



- > Tap «Setup Program».



- > Tap «Embroidery Settings».



- > Tap «Measuring Unit».
- > To display the measurements in the Embroidery Mode in inch, tap «inch».
- > To display the measurements in the Embroidery Mode in mm, tap «mm».



## Enter the Fabric Thickness

If the fabric thickness is more than 4 mm as for e.g. toweling, it is recommended to select 7.5 mm or 10 mm. The thicker the fabric, the slower the embroidery speed of the machine. When the machine is switched off, the alterations are reset to the basic setting 4 mm.



> Tap «Setup Program».



> Tap «Embroidery Settings».



> Tap «Entering the Fabric Thickness».  
> Select fabric thickness.

## Programming the Securing Stitches

Embroidery motifs are programmed either with or without securing stitches. If an embroidery motif has programmed securing stitches, they will be embroidered. If the embroidery motif is programmed with securing stitches, the securing stitches can be removed in the BERNINA Embroidery Software.

The machine recognizes when no securing stitches are programmed and adds them. If no securing stitches are wanted, they can be deactivated.



> Tap «Setup Program».



> Tap «Embroidery Settings».



> Tap «Securing Stitches».



> To deactivate the securing stitches at the start, switch off the switch in the upper section.  
– If the embroidery motif doesn't have any programmed securing stitches, none are embroidered.



> Turn on the switch in the upper section to deactivate the securing stitches at the start.  
– If the embroidery motif doesn't have any programmed securing stitches, the securing stitches are added and will be embroidered.



> Turn off the switch in the lower section to deactivate the securing stitches at the end.  
– If the embroidery motif doesn't have any programmed securing stitches, none are embroidered.



> Turn on the switch in the lower section to activate the securing stitches at the end.  
– If the embroidery motif doesn't have any programmed securing stitches, the securing stitches are added and will be embroidered.

## Centering or Opening Embroidery Designs in the Original Position

When opening the embroidery designs on the machine, they are always centered in the Embroidery Hoop. If it is desired to open embroidery designs in the original position (determined by the BERNINA Embroidery Software), the function «Centering the Embroidery Design» must be activated.



> Tap «Setup Program».



> Tap «Embroidery Settings».



> Tap «Centering the Embroidery Design».

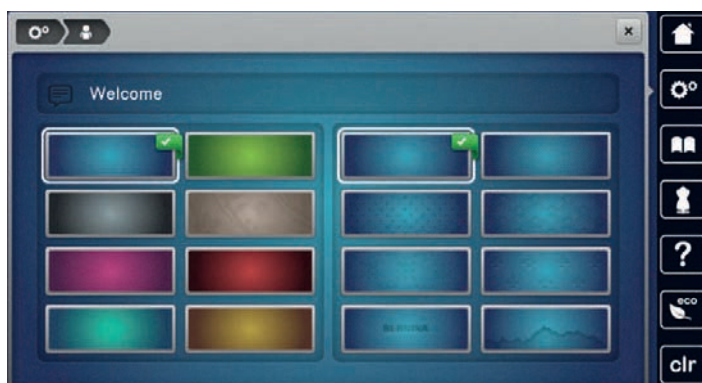




> Tap the Switch.  
– A previously moved embroidery design which has been saved in the new position is opened in the saved position after selecting.

## Setup Program

- > Tap the Switch again.
  - The embroidery design is centered to the Embroidery Hoop.




### 3.3 Selecting Personal Settings






-  > Tap «Setup Program».
-  > Tap «Personal Settings».
- > Select the required display color and background.
- > Tap the text box above the color settings.
- > Enter and confirm the welcome text.

### 3.4 Monitoring Functions

#### Activating the Upper Thread Indicator









-  > Tap «Setup Program».
-  > Tap «Monitoring Functions».
-  > Tap the switch in the upper section of the display to deactivate the upper thread indicator.
- > Tap the switch again to activate the upper thread indicator.

#### Activating the Bobbin Thread Indicator

-  > Tap «Setup Program».
-  > Tap «Monitoring Functions».
-  > Tap the switch in the lower section of the display to deactivate the bobbin thread indicator.
- > Tap the switch again to activate the bobbin thread indicator.

### 3.5 Activating the Audio Signals







-  > Tap «Setup Program».
-  > Tap «Setting Sound».
-  > To switch all audio signals on or off, tap (1).
-  > To switch off the sound when selecting a stitch pattern, tap the corresponding «Switching Sounds On/Off» in area (2).
-  > To switch on the sound when selecting a stitch pattern, tap the corresponding in area\_(2) «1 – 4».
-  > To switch off the sound for selecting functions, tap the corresponding «Switching Sounds On/Off» in area (3).
-  > To switch on the sound for selecting functions, tap the corresponding in area\_(3) «1 – 4».
-  > To deactivate the sound of the beeper when using the BSR Modes, tap «Switching Sounds On/Off» in the sector (4).

### 3.6 Machine Settings





#### Selecting a Language

The User Interface can be programmed in different languages according to the customer's wish because BERNINA provides a wide range of international languages for the customers. Via firmware updates additional languages for the User Interface can be provided.

-  > Tap «Setup Program».
-  > Tap «Machine Settings».
-  > Tap «Language Selection».
-  > Select a language.







#### Adjusting the Brightness of the Display

The brightness of the display can be set to meet your individual needs.

-  > Tap «Setup Program».
-  > Tap «Machine Settings».
-  > Tap «Display Settings».
-  > Adjust the brightness of the display in the upper section of the screen.

#### Adjusting the Sewing Light

The brightness of the sewing light can be adjusted corresponding to the personal preferences.

-  > Tap «Setup Program».
-  > Tap «Machine Settings».
-  > Tap «Display Settings».
-  > Adjust the brightness of the sewing light in the lower section of the screen.
-  > Tap the switch to switch the sewing light off.
-  > Tap the switch again to switch the sewing light on.

## Calibrating the Display

You will find more information on this topic in the chapter "Troubleshooting". (see page 182)



> Tap «Setup Program».



> Tap «Machine Settings».



> Tap «Calibrating the Screen».

> Touch the crosses in sequence using the touchscreen pen.



## Back to Basic Setting

**ATTENTION:** Using this function will delete all individually made settings.



> Tap «Setup Program».



> Tap «Machine Settings».



> Tap «Factory Setting».



> To restore all default settings for sewing, tap «Default Setting Sewing» and confirm.



> To restore all default settings for embroidering, tap «Default Setting Embroidering» and confirm.



> To restore all default settings, tap «Default Setting Machine», confirm and restart the machine.

## Deleting User Data



> Tap «Setup Program».



> Tap «Machine Settings».



> Tap «Factory Setting».



> To delete all data from the Personal Memory, tap «Delete Data from Own Storage Medium» and confirm.



> To delete all embroidery motifs from the Personal Memory, tap «Delete Personal Embroidery Designs» and confirm.

## Deleting Designs on the BERNINA USB Stick

- > Insert the BERNINA USB stick into the USB Port of the machine.
- > Tap «Setup Program».



- > Tap «Machine Settings».



- > Tap «Factory Setting».



- > Tap «Deleting USB Stick» and confirm.



## Calibrating the Buttonhole Foot #3A

The Buttonhole Foot with Slide #3A is calibrated to the machine and they should only be used both together.

Prerequisite:

- The Buttonhole Foot with Slide #3A is fitted.
- The needle is not threaded.

- > Tap «Setup Program».



- > Tap «Machine Settings».



- > Tap «Maintenance/update».



- > Tap «Calibrating the Buttonhole Foot #3A».



- > To start the calibration, push the button «Start/Stop».
  - When the calibration is complete, the result is shown in the display.



## Packing the Embroidery Module

To pack the embroidery module into the original packaging without moving the embroidery arm manually, the embroidery arm needs to be brought to its packing position.

Prerequisite:

- The embroidery module is connected with the machine.

- > Tap «Setup Program».



- > Tap «Machine Settings».



- > Tap «Maintenance/update».



- > Tap «Packing Position».
- > Follow the instructions on the display.






## Reviewing the Total Number of Stitches

The total number of stitches by the machine and the number of stitches since the last maintenance carried out by a specialist BERNINA dealer are displayed.

- > Tap «Setup Program».











## Setup Program

-  > Tap «Machine Settings».
-  > Tap «Information».
-  > Tap «Machine Data».






### Registering Details of the Dealer

The contact details for your specialized BERNINA dealer can be entered.

-  > Tap «Setup Program».
-  > Tap «Machine Settings».
-  > Tap «Information».
-  > To enter the dealer data, tap «Dealer Data».
-  > To enter the name of your specialized BERNINA dealer, tap «Name».
-  > To enter the address of the specialized BERNINA dealer, tap «Address».
-  > To enter the telephone number of the specialized BERNINA dealer, tap «Phone Number».
-  > To enter the website or e-mail address of the specialized BERNINA dealer, tap «E-mail address».

### Saving Service Data

The service data regarding the current status of the machine can be saved on a USB stick and consequently provided to the specialized BERNINA dealer.

- > Insert a USB stick which provides enough free capacity into the USB port of the machine.
-  > Tap «Setup Program».
-  > Tap «Machine Settings».
-  > Tap «Information».
-  > Tap «Service Data».
-  > Tap «Export the Service Data».
  - The icon «Export the Service Data» is outlined in white.
- > If the white frame is no longer displayed, remove the USB stick.





### Display Machine ID

The machine ID is required in order to generate the activation key.







Prerequisite:

- The most up-to-date firmware version is installed on the machine. See support page [www.bernina.com/790pro-support](http://www.bernina.com/790pro-support).

-  > Tap «Setup Program».
-  > Tap «Machine Settings».
-  > Tap «Information».
-  > Tap «Machine ID».
  - The machine ID is displayed.
  - If the «Machine ID» is not displayed, the most up-to-date version of the firmware must first be installed on the machine.






### Displaying the Machine Name

The machine name is required for the identification in a WiFi network.

-  > Tap «Setup Program».
-  > Tap «Machine Settings».
-  > Tap «Information».
-  > Tap «Machine ID».
  - The machine name (host name) is displayed.
  - The machine name can be changed (2 – 14 characters).

### Setting the WiFi Connection

For wireless data transfer, the machine can be connected to a WiFi network.

-  > Tap «Setup Program».
-  > Tap «Machine Settings».
-  > Tap «Wi-Fi Settings».
-  > Activate WiFi on the machine.
-  > Tap «Wi-Fi Networks».
  - All available networks are displayed.
- > Select the network.
- > Enter and confirm the password.
  - The machine is connected to the network, and the status is displayed.

### Setting a Hidden Network

- > Tap «Other» in the list of available networks.
- > Enter the name of the network (SSID) and confirm it..
- > Enter and confirm the password.
  - The machine is connected to the network, and the status is displayed.

## 4 System Settings

### 4.1 Calling Up the Tutorial

The Tutorial gives information and explanations, covering various aspects of sewing, embroidering, and the different stitches.



- > Tap «Tutorial».
- > Select the desired topic in order to view information.

### 4.2 Calling Up the Creative Consultant

The Creative Consultant provides decision support for sewing projects. After entering the kind of fabric and the desired sewing project, suggestions concerning the suitable needle or the appropriate presser foot are displayed.



- > Tap «Creative Consultant».
- > Select the fabric on which you want to sew.
- > Select the sewing project.



- > Tap «Confirm».
- The settings are adjusted.

### 4.3 Calling up the Embroidery Consultant

The Embroidery Consultant informs you about decision support for embroidery projects. After entering the desired embroidery project and the fabric, suggestions for the suitable needle and the suitable embroidery foot are displayed.



- > Tap «Embroidery Consultant».
- > Select the embroidering project.
- > Select the fabric on which you want to embroider.



- > Tap «Confirm».
- If an embroidery motif has already been selected, a warning appears stating that this will be overwritten.

### 4.4 Calling Up the Help



- > Touch the window in the display where help is needed.
- > To start the Help Mode, tap «Help» twice.
- > Tap the icon in the display where help is needed.

### 4.5 Using eco Mode

During a longer interruption of work the machine can be set into a power save mode. The power save mode also serves as a child safety feature. Nothing can be selected in the display and the machine cannot be started.



- > To activate the power save mode, tap «eco Mode».
- The display goes to sleep. The power consumption is reduced and the sewing light is off.
- > To deactivate the power save mode, tap «eco Mode» again.

### 4.6 Cancelling Any Alterations with «clr»

Any alterations to designs can be reset to basic setting. Exceptions are saved designs which have been filed in the personal memory and monitoring functions.



- > Tap «Clear Settings».



## 5 Creative Sewing

### 5.1 Overview Selection Menu Sewing



- |   |                       |   |                   |
|---|-----------------------|---|-------------------|
| 1 | «Practical Stitches»  | 5 | «Quilt Stitches»  |
| 2 | «Decorative Stitches» | 6 | «Personal Memory» |
| 3 | «Alphabets»           | 7 | «History»         |
| 4 | «Buttonholes»         |   |                   |

#### Selecting a Stitch Pattern

- > Select a stitch pattern, alphabet or buttonhole.
- > To increase the view, tap «Increasing/Decreasing the Display Size» (1).



- > To decrease the view, tap «Increasing/Decreasing the Display Size» again.
- > To select the stitch pattern via the stitch number entry, tap «Select Stitch Pattern by Number».

### 5.2 BERNINA Dual Feed

The BERNINA Dual Feed feeds the fabric from above and from beneath simultaneously. This provides an even and careful feed forward even for smooth and thin materials. Striped and checkered patterns can be matched perfectly by even feeding.

In general, the BERNINA Dual Feed is used for the following sewing projects:

- Sewing: All sewing projects with difficult fabrics, e. g. seams, zippers
- Patchwork: With accurate stripes, blocks and with decorative stitches up to a stitch width of 9 mm
- Appliqués: Sewing on ribbons and bias binding

Difficult-to-work-with fabrics are:

- Velvet, normally sewn with the grain
- Toweling
- Jersey, especially when sewing it crosswise to knit
- Fake fur or coated fake fur

- Fleece-types of fabrics
- Batted fabrics
- Stripes and checks
- Curtain fabrics with pattern repeats

«Sticky» fabrics are:

- Imitation leather, coated fabrics (optimally with optional accessory Zigzag Foot with Non-Stick Sole #52D)

### Switching On/Off the BERNINA Dual Feed

Only use the Dual Feed presser feet with a cut-out at the center back and the labeling «D».

#### Activating the BERNINA Dual Feed

- > Raise the presser foot.
- > Attach a presser foot with the designation «D».
- > Pull the dual feed down until it engages.



#### Deactivating the BERNINA Dual Feed

- > Raise the presser foot.
- > Hold the dual feed by the handle with two fingers, pull it down and then push it away from you and let it slide slowly upwards.



### 5.3 Regulating the Speed

The sewing speed can be adjusted infinitely variable with the slide.

- > Move the slide to the left to reduce the sewing speed.
- > Move the slide to the right to increase the sewing speed.



## 5.4 Adjusting the Upper Thread Tension

The default setting of the upper thread tension is set automatically as soon as a stitch pattern or an embroidery motif is selected.

The upper thread tension is set optimally at the BERNINA factory and the machine has been tested. Metrosene-/Seralon thread size 100/2 (Company Mettler, Switzerland) is used for upper and bobbin thread.

When of using other types of sewing or embroidery threads, the optimal tension may vary. Therefore it may be necessary to adjust the upper thread tension according to the sewing or embroidering project as well as the desired stitch pattern or the embroidery motif individually.

The higher the upper thread tension, the tighter the upper thread which means that the bobbin thread is pulled up to the top of the fabric. When the upper thread tension is low, the upper thread is less tightened which means that the bobbin thread is pulled up less.

Alteration to the upper thread tension affect the currently selected stitch pattern or embroidery motif. Permanent alterations of the upper thread tension for the Sewing Mode (see page 51) and for the Embroidering Mode (see page 54) can be made in the Setup Program.

Prerequisite:

- The upper thread tension has been altered in the setup program.



- > Tap «Upper Thread Tension».
- > Adjust the upper thread tension.



- > Tap the yellow-outlined icon on the right side to reset the alterations to the default setting.
- > Tap the yellow-outlined icon on the left side to reset the alteration to default setting in the **Setup Program**.

## 5.5 Editing Stitch Patterns

### Changing the Stitch Width

- > Turn the «Upper Multi-function Knob» to the left to narrow the stitch width.
- > Turn the «Upper Multi-function Knob» to the right to widen the stitch width.
- > To call up further setting options, tap the icon «Stitch width» (1).



## Changing the Stitch Length

- > Turn the «Lower Multi-function Knob» to the left to shorten the stitch length.
- > Turn the «Lower Multi-function Knob» to the right to elongate the stitch length.
- > To call up other setting options, tap «Stitch Length» (1).



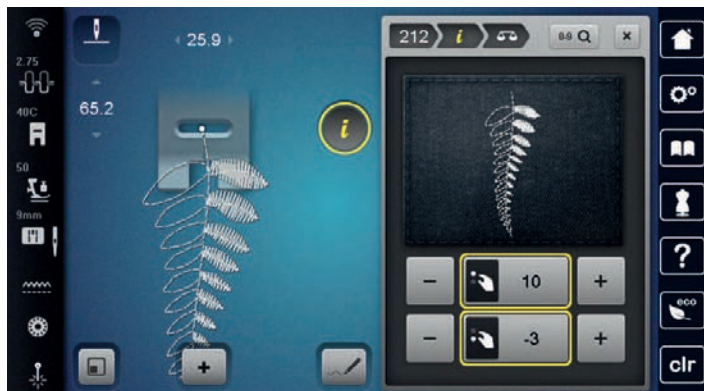
## Correcting the Balance

Different fabrics, threads and stabilizers can affect the programmed stitch patterns so that they cannot be sewn out correctly. The electronic balance can correct these deviation and the stitch pattern can be adjusted optimally to the selected fabric.

- > Select a stitch pattern or alphabet.
- > Sewing stitch pattern.
- > Tap «i-Dialog».



- > Tap «Balance».
  - A preview of the stitch pattern is displayed.



- > Turn the «Upper Multifunction knob» to correct the horizontal direction of the stitch pattern.
- > To correct the longitudinal direction of the stitch pattern, turn the «Lower Multi-function Knob» until the preview of the stitch pattern matches the stitch pattern sewn on the fabric.



- > Altered Balance settings can be saved for each stitch in the «Personal Memory» .
- > Altered Balance settings only remain valid until the «Clear Settings» is pushed or the machine is switched off.



## Programming Pattern Repeat

Stitch patterns can be repeated up to 99 times.

- > Select a stitch pattern or alphabet.
- > Tap «i-Dialog».






- > Tap «Pattern Repeat».
- > Enter the required number of stitch patterns.





-  > Tap «Confirm».
-  > To deactivate the pattern repeat, tap and hold «Pattern Repeat».

### Programming Long Stitch

The maximum length for long stitches is 12 mm and the machine sews every second stitch.





-  > Select a stitch pattern.
-  > Tap «i-Dialog».
-  > Tap «Long Stitch».

### Mirror Image of Stitch Patterns

-  > Select a stitch pattern or alphabet.
-  > Tap «i-Dialog».
-  > To mirror the stitch pattern from left to right, tap «Mirror Image Left/Right».
-  > To mirror the stitch pattern in sewing direction, tap «Mirror Image Up/Down».






### Edit Stitch Pattern Length

The stitch patterns can be lengthwise extended or shortened.

-  > Select a stitch pattern or alphabet.
-  > Tap «i-Dialog».
-  > Tap «Edit Stitch Pattern Length».
-  > Adjust the stitch pattern length.

### Programming the Stitch Counter Function

The Stitch Counter function cannot be set for all stitch patterns. If, for example, the Honeycomb Stitch No. 8 is selected, the stitch counter function cannot be used.

-  > Select the stitch pattern.
-  > Tap «i-Dialog».
-  > Tap «Programming the Length via the Stitch Counter».
-  > Sew the desired length.
-  > Push the button «Quick Reverse».
  - The display changes to «Auto» and the selected stitch pattern in the new length is saved until the machine is switched off.

## Sewing Stitch Patterns Using the Triple Stitch

The stitch pattern can be sewn three times for a more attractive result. Not all stitch patterns can be sewn using the triple stitch.

- > Select the stitch pattern.
- > Tap «i-Dialog».



- > Tap «Triple Stitch».

## Quick Reverse

- > Select a stitch pattern or alphabet.
- > To switch immediately to sewing in reverse when pushing the button «Quick Reverse», select Needle Stop Down (permanent).
- > Program needle stop up (permanent) to sew another stitch forward before the machine switches to reverse sewing.



- > Push and hold the button «Quick Reverse».

## Permanent Quick Reverse

- > Select a stitch pattern or alphabet.
- > Tap «i-Dialog».



- > To sew permanently in reverse, tap «Permanent Reverse Sewing».
  - The machine sews permanently in reverse until «Permanent Reverse Sewing» is tapped again.

## Backstepping

- > Select a stitch pattern or alphabet.
- > Tap «i-Dialog».



- > To backstep the last 200 stitches, tap «Back Stepping».

## Changing the Sewing Direction

- > Select a stitch pattern or alphabet.
- > Tap «i-Dialog».

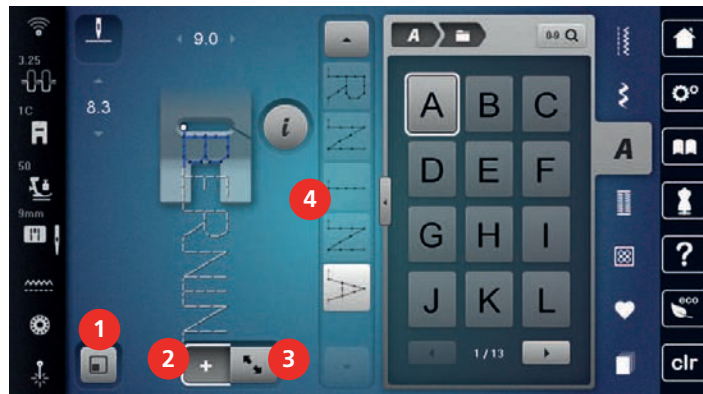


- > Tap «Change the Sewing Direction».
- > Use the «Upper Multi-function Knob» or «Lower Multi-function Knob» to rotate the stitch pattern in 0.5° steps.
- > Rotate the stitch pattern or the alphabet via the icon «Directional Sewing» (1) in 45° steps.



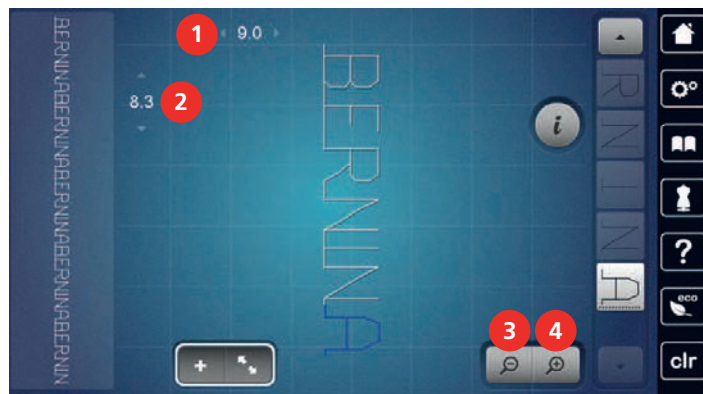
## 5.6 Combining Stitch Patterns

### Overview Combi Mode



- |   |                                     |   |  |
|---|-------------------------------------|---|--|
| 1 | «Stitch Pattern View Fit to Screen» | 3 | «Edit Mode/Extended Edit Mode»                   |
| 2 | «Combination Mode/Single Mode»      | 4 | Individual Stitch Pattern within the Combination |

### Overview Combi Mode Extended



- |   |                 |   |            |
|---|-----------------|---|------------|
| 1 | «Stitch Width»  | 3 | «Zoom Out» |
| 2 | «Stitch Length» | 4 | «Zoom In»  |

### Creating Stitch Pattern Combinations

In the Combi Mode stitch patterns and alphabets can be combined according to your wish. By combining any alphabet letters, the logo BERNINA can be created.



- > Tap «Combination Mode/Single Mode».
- > Select the desired stitch patterns.





> To get back to the Single Mode, tap «Combination Mode/Single Mode» again.

### Saving a Stitch Pattern Combination

To use an individually created stitch pattern combinations again, they can be saved in the folder «Personal Memory».

Prerequisite:

- A stitch pattern combination has been created.



> Tap «Personal Memory».



> Tap «Save Stitch Pattern».



> To save the stitch pattern combination, tap «Confirm».

### Loading a Stitch Pattern Combination



> Tap «Combination Mode/Single Mode».



> Tap «Personal Memory».



> Tap «Loading a Stitch Pattern Combination».  
> Select a stitch pattern combination.

### Overwriting a Stitch Pattern Combination

Prerequisite:

- A stitch pattern combination has been created.



> Tap «Personal Memory».



> Tap «Save Stitch Pattern».  
> Select the stitch pattern combination which is to be overwritten.



> To overwrite the stitch pattern combination, tap «Confirm».

### Deleting a Stitch Pattern Combination

Prerequisite:

- A stitch pattern combination has been created.



> Tap «i-Dialog».



> Tap «Edit Entire Combination».



> Tap «Deleting».



> Tap «Confirm».





## Editing the View of the Stitch Pattern Combination

Prerequisite:

- A stitch pattern combination has been created.



> Tap «Edit Mode/Extended Edit Mode».



> To minimize the stitch combination view, tap «Zoom Out».



> To enlarge the stitch combination view, tap «Zoom In».



> To get back to the combi-mode, tap «Edit Mode/Extended Edit Mode».

## Editing a Single Stitch Pattern

Prerequisite:

- A stitch pattern combination has been created.
- > To select a single stitch pattern, tap the desired position (1) within the stitch pattern combination.



> To edit the single stitch pattern, tap «i-Dialog».

## Deleting a Single Stitch Pattern

Prerequisite:

- A stitch pattern combination has been created.
- > Tap the desired stitch pattern (1) within the stitch pattern combination.



> Tap «i-Dialog».



> Tap «Deleting».

## Adding a Single Stitch Pattern

The new stitch pattern is always inserted after the selected stitch pattern.

Prerequisite:

- A stitch pattern combination has been created.
- > To select a single stitch pattern, tap the desired position (1) within the stitch pattern combination.



- > Select a new stitch pattern.

## Relocating a Single Stitch Pattern

Prerequisite:

- A stitch pattern combination has been created.



- > Tap «Edit Mode/Extended Edit Mode».  
> Tap the desired stitch pattern within the stitch pattern combination.



- > Tap «i-Dialog».



- > Tap «Relocating a Stitch Pattern».  
> Relocate the stitch pattern.  
– The connecting stitches between the stitch patterns are added automatically.

## Adapting the Stitch Pattern Length and Stitch Pattern Width

The length and width of the individual stitch patterns in a stitch pattern combination can be adapted to the longest and widest stitch patterns in the combination.

Prerequisite:

- A stitch pattern combination has been created.



- > Tap «i-Dialog».



- > Tap «Edit Entire Combination».

- > Tap «Total Pattern Length» (1).



- > Tap «Adjust Length within the Combination» (2).
  - The lengths of the stitch patterns are adapted to the length of the longest stitch pattern in the combination.
- > Tap «Stitch Width» (3).



- > Tap «Adjust Width within the Combination» (4).
  - The widths of all of the stitch patterns are adapted to the width of the widest stitch pattern in the combination.

Furthermore, the length and width of the stitch pattern combination are increased or decreased proportionally.

- > To decrease the width of the stitch pattern combination proportionally, turn the «Upper Multi-function knob» to the left.
- > To increase the width of the stitch pattern combination proportionally, turn the «Upper Multi-function knob» to the right.
- > To decrease the length of the stitch pattern combination proportionally, turn the «Lower Multi-function knob» to the left.
- > To increase the length of the stitch pattern combination proportionally, turn the «Lower Multi-function knob» to the right.

## Mirroring a Stitch Pattern Combination

Prerequisite:

- A stitch pattern combination has been created.



- > Tap «i-Dialog».



- > Tap «Edit Entire Combination».



- > To mirror the whole stitch pattern combination from left to right, tap, «Mirror Image Left/Right».
- > To reset the changes and revert to the default settings, tap «Mirror Image Left/Right».



## Stitch Pattern Combination Subdivider 1

A stitch pattern combination can be subdivided into several sections. The subdivision is inserted below the cursor. Only the section in which the cursor is placed will be sewn. To sew the next section, the cursor must be placed in this section.

Prerequisite:

- A stitch pattern combination has been created.
- > Select the desired position within the stitch pattern combination where the stitch pattern combination is to be subdivided.
- > Tap «i-Dialog».



- > Tap «Edit Combination at Cursor Position».



- > Tap «Combination Subdivider (1)».

## Stitch Pattern Combination Subdivider 2

A stitch pattern combination can be interrupted at different positions. The interruption is inserted below the cursor.

Prerequisite:

- A stitch pattern combination has been created.
- > Select the desired position within the stitch pattern combination where the stitch pattern combination is to be interrupted.
- > Tap «i-Dialog».



- > Tap «Edit Combination at Cursor Position».



- > Tap «Combination Subdivider (2)».
- > Sew stitch pattern combination up to the interruption and reposition the fabric.

## Securing a Stitch Pattern Combination

Prerequisite:

- A stitch pattern combination has been created.
- > Select the desired position within the stitch pattern combination where the stitch pattern combination is to be secured.
- > Tap «i-Dialog».



- > Tap «Edit Combination at Cursor Position».



- > Tap «Securing Stitches».
  - Every single pattern of the stitch pattern combination can be secured at the start or at the end.

## Relocating Several Stitch Patterns

Prerequisite:

- A stitch pattern combination has been created.
- > Tap «Edit Mode/Extended Edit Mode».
- > Select the stitch pattern within the stitch pattern combination.






-  > Tap «i-Dialog».
-  > Tap «Relocating a Single Pattern or Parts of a Combination».
- > Relocate a part of the stitch pattern combination.

## Programming Pattern Repeat

Prerequisite:




- A stitch pattern combination has been created.

-  > Tap «i-Dialog».
-  > Tap «Edit Entire Combination».
-  > To repeat the stitch pattern combination, tap «Pattern Repeat» 1x.
- > To repeat the stitch pattern combination up to 9x, tap «Pattern Repeat» again.
- > To deactivate the pattern repeat, tap and hold «Pattern Repeat» or tap «Clear Settings».

## Changing the Sewing Direction of a Stitch Pattern

Prerequisite:





- A stitch pattern combination has been created.

-  > Tap «Edit Mode/Extended Edit Mode».
- > Select the desired stitch pattern within the stitch pattern combination.
-  > Tap «i-Dialog».
-  > Tap «Change the Sewing Direction».
- > To rotate the stitch pattern combination in 0.5° steps, turn the «Upper Multi-function Knob» or «Lower Multi-function Knob».

## Changing the Sewing Direction of a Stitch Pattern Combination


Prerequisite:

- A stitch pattern combination has been created.

-  > Tap «Edit Mode/Extended Edit Mode».
-  > Tap «i-Dialog».
-  > Tap «Edit Entire Combination».
-  > Tap «Change the Sewing Direction».
- > To rotate the stitch pattern combination in 0.5° steps, turn the «Upper Multi-function Knob» or «Lower Multi-function Knob».

## 5.7 Administering Stitch Patterns

### Saving Settings of Stitch Patterns

- > Select a stitch pattern, alphabet or buttonhole.
-  > Tap «i-Dialog».
- > Edit the stitch, alphabet or buttonhole.



> To save all alterations permanently, tap «Save Stitch Pattern Settings».



> To cancel all alterations, tap «Reset Stitch Pattern».

### Calling Up the Previously Sewn Stitch Patterns

The 15 previously sewn stitch patterns are saved automatically and can be called up at any time.



> To display the previously sewn stitch patterns, tap «History».

> Select a stitch pattern.

### Saving Stitch Patterns in Personal Memory

In the folder «Personal Memory» any stitch patterns, also those which have been individually edited, can be saved.

> Select a stitch pattern, alphabet or buttonhole.

> Edit the stitch pattern.



> Tap «Personal Memory».



> Tap «Save Stitch Pattern».

> Select the file where the pattern is to be saved.



> Tap «Confirm».

### Overwriting Stitch Patterns from the Personal Memory

Prerequisite:

- The stitch pattern is saved in the personal memory.

> Select a stitch pattern, alphabet or buttonhole.

> Edit the stitch pattern.



> Tap «Personal Memory».



> Tap «Save Stitch Pattern».

> Select the file where the stitch pattern to be overwritten has been saved.

> Select the stitch pattern which should be overwritten.



> Tap «Confirm».

### Loading Stitch Patterns from the Personal Memory

Prerequisite:

- The stitch pattern is saved in the personal memory.



> Tap «Personal Memory».



> Tap «Load Embroidery Design».

> Select the file where the stitch pattern has been saved.

> Select the stitch pattern.

### Deleting Stitch Patterns from the Personal Memory



Prerequisite:

- The stitch pattern is saved in the personal memory.







> Tap «Personal Memory».





-  > Tap «Deleting».
- > Select the file where the stitch pattern has been saved.
- > Select the stitch pattern.
-  > To delete the stitch pattern, tap «Confirm».

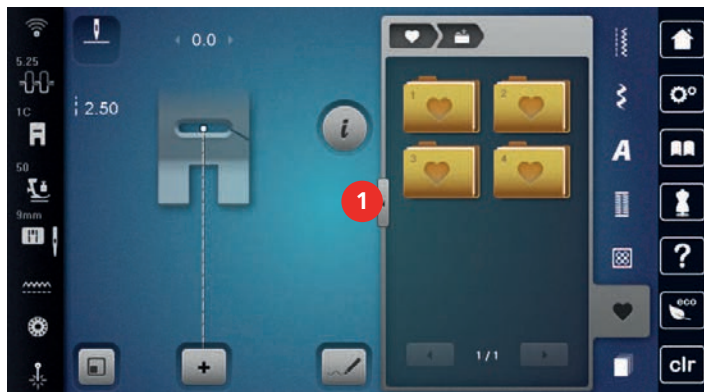
### Saving Stitch Patterns on the BERNINA USB Stick


On the BERNINA USB stick stitch patterns, also those which have been individually edited, can be saved.

- > Select a stitch pattern or alphabet.
- > Editing stitch patterns.
-  > Tap «Personal Memory».
-  > Tap «Save Stitch Pattern».
- > Insert the BERNINA USB stick into the USB port of the machine.
-  > Tap «USB Stick».
-  > Tap «Confirm».




### Uploading a Stitch Pattern from the BERNINA USB Stick

-  > Tap «Personal Memory».
-  > Tap «Load Embroidery Design».
- > Tap «Increasing/Decreasing the Display Size» (1).



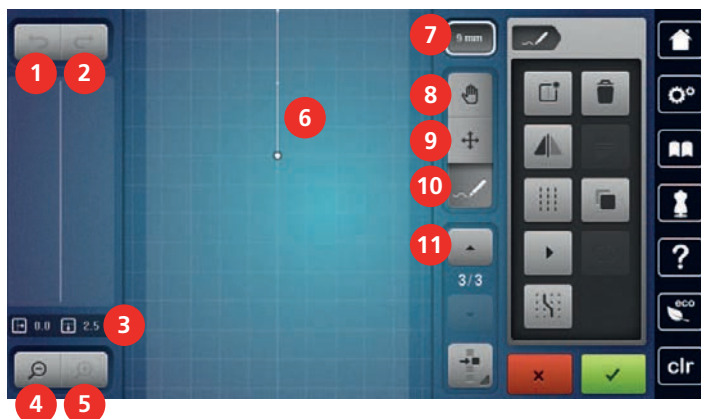
- > Insert the BERNINA USB stick into the USB port of the machine.
-  > Tap «USB Stick».
- > Select the desired stitch pattern.

### Deleting Stitch Patterns from the BERNINA USB Stick

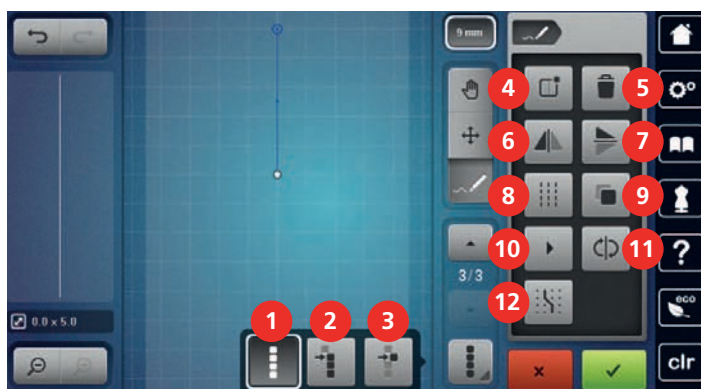
-  > Tap «Personal Memory».
-  > Tap «Deleting».
- > Insert the BERNINA USB stick into the USB port of the machine.
- > Select the stitch pattern which is to be deleted.
-  > Tap «Confirm».

## 5.8 Stitch Designer

### Overview Stitch Designer



- |   |                     |    |                         |
|---|---------------------|----|-------------------------|
| 1 | «Undo Entries»      | 7  | «Limit Pattern Width»   |
| 2 | «Redo Entries»      | 8  | «Move View»             |
| 3 | Point Position      | 9  | «Relocate Points»       |
| 4 | «Zoom Out»          | 10 | «Insert/Edit a Stitch»  |
| 5 | «Zoom In»           | 11 | «Scroll Through Points» |
| 6 | Stitch Pattern View |    |                         |



- |   |                                  |    |                               |
|---|----------------------------------|----|-------------------------------|
| 1 | «Select all Points»              | 7  | «Mirror Image Up/Down»        |
| 2 | «Select from a Particular Point» | 8  | «Triple Stitch»               |
| 3 | «Select a Single Point»          | 9  | «Duplicate»                   |
| 4 | «Create a New Stitch Pattern»    | 10 | «Virtual Sew Out»             |
| 5 | «Deleting»                       | 11 | «Reverse the Stitch Sequence» |
| 6 | «Mirror Image Left/Right»        | 12 | «Snap to Grid»                |

### Creating Your Own Stitch Pattern



The stitch patterns which have been created in the Stitch Designer can be saved in your «Personal memory».





The Stitch Designer allows creating your personal stitch patterns as well as editing existing stitch patterns. You can create your own stitch patterns on the display by free movement.

In the left portion of the display the position of the currently active point is indicated additionally: The horizontal distance of the point to the center line is indicated in millimeters. The vertical distance of the point to the previous point is also indicated in millimeters.









-  > Tap «Stitch Designer».
-  > Tap «Create a New Stitch Pattern».
- > Add a point on the display.
- > Add more points on the display as desired.
-  > Tap «Confirm».






### Editing the View

- > Select a stitch pattern, alphabet or buttonhole.
-  > Tap «Stitch Designer».
-  > To minimize the stitch pattern view, tap «Zoom Out».
-  > To enlarge the minimized stitch pattern view, tap «Zoom In».
-  > Tap «Move View».
- > Moving the view of the design.

### Inserting Points

- > Select a stitch pattern, alphabet or buttonhole.
-  > Tap «Stitch Designer».
-  > To show grid points, tap «Snap to Grid».
  - Every inserted point is automatically placed on the nearest grid point.
-  > To select the point after which a new one is to be inserted, touch «Scroll Up».
-  > To select the point after which a new one is to be inserted, touch «Scroll Down».
- > Insert further points.
-  > To undo the last work step, tap «Undo Entries».
-  > To redo the last work step, tap «Redo Entries».

### Relocating the Points

- > Select a stitch pattern, alphabet or buttonhole.
-  > Tap «Stitch Designer».
-  > Tap «Select a Single Point».
-  > Tap «Select from a Particular Point».
-  > To add the previous point to the selection, tap «Scroll Up».
-  > To add the following point to the selection, tap «Scroll Down».
- > To move the selected points horizontally, turn the «Upper Multi-function Knob».
- > To move the selected points vertically, turn the «Lower Multi-function Knob».

### Duplicating Points

- > Select a stitch pattern, alphabet or buttonhole.
-  > Tap «Stitch Designer».



> Tap «Select a Single Point».



> Tap «Select from a Particular Point».



> To add the previous point to the selection, tap «Scroll Up».



> To add the following point to the selection, tap «Scroll Down».



> Tap «Duplicate».

### Deleting Points



> Select a stitch pattern, alphabet or buttonhole.

> Tap «Stitch Designer».



> Tap «Select a Single Point».



> Tap «Select from a Particular Point».



> To add the previous point to the selection, tap «Scroll Up».



> To add the following point to the selection, tap «Scroll Down».



> To delete all selected points of the stitch pattern, tap «Deleting».

### Activating the Triple Stitch



> Select a stitch pattern, alphabet or buttonhole.

> Tap «Stitch Designer».



> Tap «Select from a Particular Point».



> To select the previous point, tap «Scroll Up».



> To select the following point, tap «Scroll Down».



> To set the triple stitch for the marked points, tap «Triple Stitch».

### Mirror Image of Stitch Patterns



> Select a stitch pattern, alphabet or buttonhole.

> Tap «Stitch Designer».



> Tap «Select a Single Point».



> Tap «Select all Points».



> To mirror all points in the transverse direction, tap «Mirror Image Left/Right».



> To mirror all points in the longitudinal direction, tap «Mirror Image Up/Down».



## Reversing the Stitch Sequence



- > Select a stitch pattern, alphabet or buttonhole.
- > Tap «Stitch Designer».



- > Tap «Select a Single Point».



- > Tap «Select all Points».



- > Tap «Reverse the Stitch Sequence».

## Designing a Stitch Pattern from Scratch



- > Select a stitch pattern, alphabet or buttonhole.
- > Tap «Stitch Designer».



- > Tap «Virtual Sew Out».

## Determining the Stitch Pattern Width

The width of the stitch pattern is limited to 9 mm. To sew wider patterns, for example Sideways Motion patterns, it is necessary to deactivate the limitation.



- > Select a stitch pattern, alphabet or buttonhole.
- > Tap «Stitch Designer».

9 mm

- > To deactivate the limitation, tap «Limit Pattern Width».
- > To activate the limitation, tap «Limit Pattern Width» again.

## 5.9 Securing Stitches

### Securing a Seam with the Button «Securing»

The «Securing Stitches» button can be programmed with various securing stitches.



- > Pressing the «Securing Stitches» button before starting to sew.
  - The stitch pattern/stitch pattern combination is secured with the number of programmed stitches when sewing is started.
- > Press the «Securing Stitches» button while sewing.
  - The machine stops immediately and secures with the number of programmed stitches.

### Securing with the Button «Pattern End»

The «Pattern End» button can be programmed with various securing stitches.

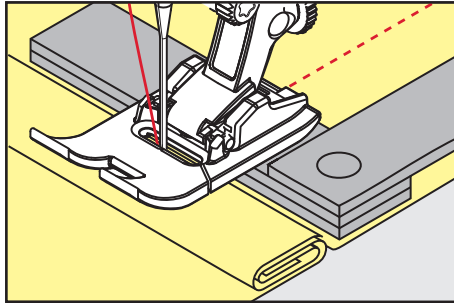


- > Push the button «Pattern End» before sewing is started or while sewing.
  - While sewing, a stop icon indicates that the function is activated and the stitch pattern or the current combination of a stitch pattern will be secured at the end with the programmed number of stitches.

## 5.10 Height Compensation of Uneven Layers

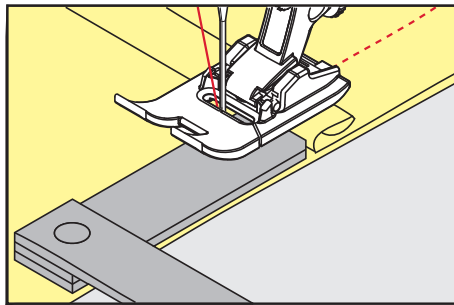
If the presser foot is at an angle when sewing over a thick seam, the feed dog cannot grip the fabric and the sewing project cannot be sewn out properly.

- > Place 1 – 3 compensating plates as required from the back of the presser foot close to the needle to level the fabric layer.



- The presser foot is leveled with the sewing project.

- > Place 1 – 3 compensating plates as required from the front of the presser foot close to the needle to level the fabric layer.



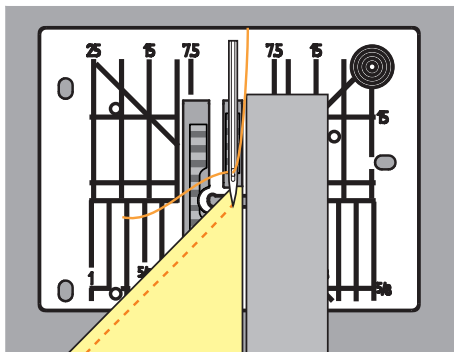
- The presser foot is leveled with the sewing project.

- > Sew until the complete presser foot has passed the thick seam.
- > Remove the plates of the height compensation.

## 5.11 Sewing Corners

When sewing corners, only a small section of the fabric is actually on the feed dog. Therefore it cannot grip the fabric well. By means of the height compensation tool the fabric can be fed evenly.

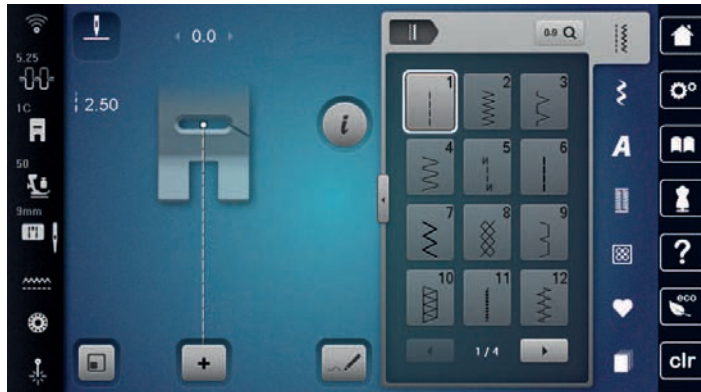
- > When the fabric edge is reached, stop the sewing process with needle position down.
- > Raise the presser foot.
- > Turn the fabric and place in desired position.
- > Place 1 – 3 compensating plates as required on the right of the presser foot close to the sewing project.
- > Lower the presser foot.

















- > Resume sewing until the sewing project is on the feed dog again.














## 6 Practical Stitches

### 6.1 Overview Practical Stitches

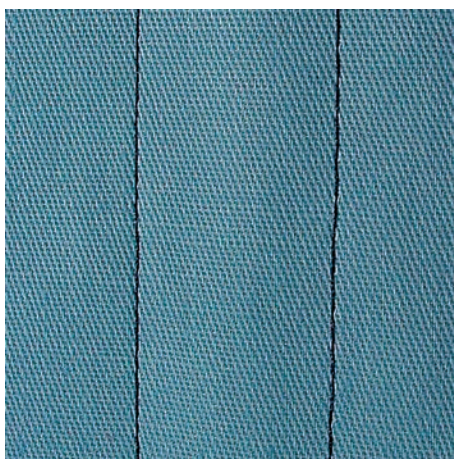


Stitch patterns	Stitch number	Name	Description
---	1	Straight Stitch	To join seams, for topstitching and basting.
W	2	Zigzag	To finish edges, to sew elastic seams, to sew on lace inserts and elastics.
V	3	Vari-Overlock	For finishing edges, sewing together and simultaneously finishing elastic fabrics.
W	4	Running Stitch	For darning and reinforcing fabric edges or attaching lace or rubber tape.
↔	5	Securing Program	For automatic securing at the start of the seam with forward and reverse stitches.
---	6	Triple Straight Stitch	For reinforced seams on heavy fabrics and decorative effects.
W	7	Triple Zig zag	For durable seams on strong fabrics, visible hems and decorative seams.
X	8	Honeycomb Stitch	For stretch fabrics and hems, including with rubber threads.
W	9	Blind Stitch	For blind hems on most fabric types and for shell edging on soft jerseys and fine fabric.
W	10	Double Overlock	For simultaneously sewing together and finishing elastic fabrics.
W	11	Superstretch Stitch	For highly stretch open seams.

Stitch patterns	Stitch number	Name	Description
	12	Gathering Stitch	For gathering with rubber threads and for flat joining seams on medium-weight fabrics.
	13	Stretch Overlock	For simultaneously sewing together and finishing elastic fabrics, as well as for flat joining seams.
	14	Tricot Stitch	For visible hems and seams in lingerie and sweaters and for mending tricot fabric.
	15	Universal Stitch	For flat joining seams, visible hems and decorative seams in strong fabrics such as felt and leather and for attaching rubber tape.
	16	Sewn-out Zigzag	For finishing and reinforcing fabric edges, for sewing on rubber tape and for decorative seams.
	17	Lycra Stitch	For flat joining seams, visible hems on Lycra fabric and for stitching over seams in foundation garments.
	18	Stretch Stitch	For stretchable seams and hems in woven and knitted fabrics.
	19	Reinforced Overlock	For overlock seams or flat joining seams on medium-weight knit fabrics and toweling.
	20	Knit Overlock	For stretchable seams and hems in woven and knitted fabric, for sewing and finishing.
	21	Basting stitch	For tacking seams and hems and for quilting projects.
	22	Simple Darning Program	For automatic darning in fine to strong fabrics.
	23	Reinforced Darning Program	For automatic darning in strong materials.
	24	Bartack Program	For reinforcing pocket openings, buttonhole bars and for sewing belt loops.
	25	Bartack Program	For reinforcing pocket openings, sewing belt loops and securing seam ends.

Stitch patterns	Stitch number	Name	Description
	26	Large Fly Stitch	For reinforcing pocket openings, zippers and slits in medium-weight to thick fabrics.
	27	Small Fly Stitch	For reinforcing pocket openings, zippers and slits in fine to medium-weight fabrics.
	29	Narrow Blind Stitch	For blind hems and shell edging in light, fine and soft fabrics.
	31	Triple straight stitch with long stitch	For durable seams in strong fabrics, e.g. visible and decorative seams.
	32	Single Straight Stitch	As a connecting stitch in a combination for one straight stitch.
	33	Three Single Straight Stitches	As connecting stitches in a combination for three individual straight stitches.
	34	Darning Stitch	For darning together with the function "Quick Reverse".
	35	Open Overlock Stitch	For simultaneously sewing together and finishing elastic fabrics with a reinforced edge.
	36	Overlock	For medium-weight knitted goods.
	37	Reinforced Overlock Stitch	For simultaneously sewing together, finishing and reinforcing elastic fabrics.
	38	Chain stitch	For decorative and reinforcing stitches on most woven fabrics.
	39	Cover stitch effect	To sew decorative seams and hems in heavy knitted goods and woven fabrics.
	40	Cover stitch effect	To sew decorative seams and hems in heavy knitted goods and woven fabrics.

## 6.2 Sewing Straight Stitch



Adjust the stitch length for the sewing project, e.g. a long stitch for denim (approx. 3 – 4 mm) and a short stitch for delicate fabric (approx. 2 – 2.5 mm). Adjust the stitch length depending on the thread thickness, e.g. a long stitch (approx. 3 – 5 mm) for top-stitching with gimp.

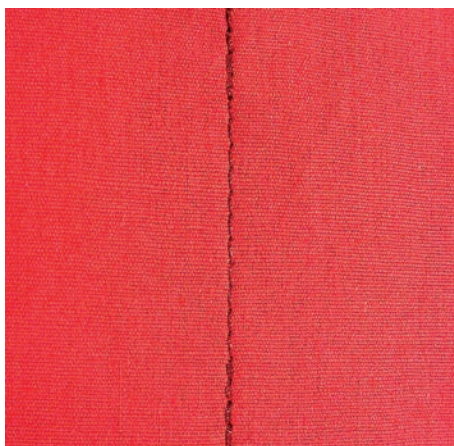
Prerequisite:

- The Reverse Pattern Foot #1C/1D is fitted.



- > Tap «Practical Stitches».
- > Select Straight Stitch No. 1.

## 6.3 Securing with the Automatic Securing Program



Due to a determined number of 6 stitches sewn forwards and 6 stitches sewn in reverse, the securing is regular.

Prerequisite:

- The Reverse Pattern Foot #1C is fitted.



- > Tap «Practical Stitches».
- > Select Securing Program No. 5.
- > Press the foot control.
  - The machine secures automatically.

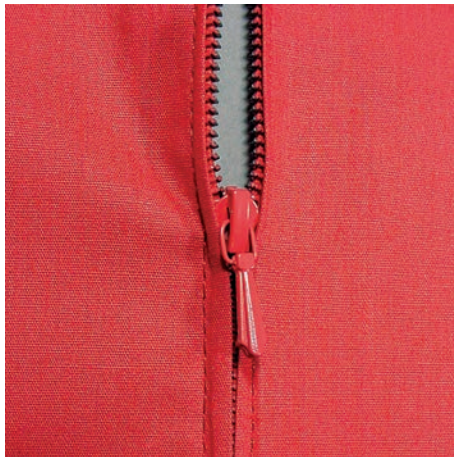


- > Sew the seam at the desired length.
- > Push the button «Quick Reverse».
  - The machine secures automatically and stops at the end of the securing program.





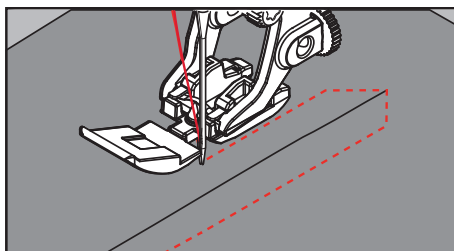
## 6.4 Sewing in the Zipper



As the fabric feed can be difficult when starting to sew, it is recommended to hold the threads firmly or to pull the fabric slightly to the back for a few stitches or to sew 1 – 2 cm reverse first.



- > Fit the Reverse Pattern Foot #1C.
- > Tap «Practical Stitches».
- > Select Straight Stitch No. 1.
- > Sew the seam up to where the zipper starts.
- > Sew the securing stitches.
- > Close the zipper length with long stitches.
- > Finish the seam allowances.
- > Iron the seam.
- > Open the zipper length.
- > Baste the zipper under the fabric so that the fabric folded edges meet over the center of the zipper.
- > Open the zipper a few centimeters.
- > Fit the Zipper Foot #4D.
- > Move the needle position to the right.
- > Use the Free Hand System to raise the presser foot and to position the sewing project.
- > Start sewing from top left.
- > Guide the foot so that the needle stitches along the zipper coils.
- > Stop in front of the zipper pull with needle position down.
- > Raise the presser foot.
- > Close the zipper.
- > Continue to sew and stop in front of the base of the zipper with needle position down.
- > Raise the presser foot and turn the sewing project.
- > Sew across the other side of the zipper and stop with needle position down.
- > Raise the presser foot and turn the sewing project.
- > Sew the second side from bottom to top.



## 6.5 Sewing Both Sides of the Zipper from Bottom to Top

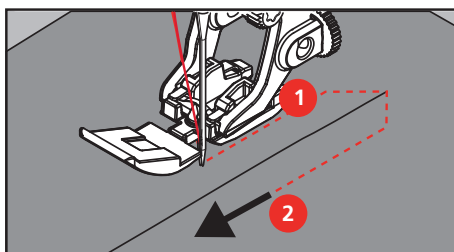
For fabrics with pile, such as velvet, it is recommended to sew in the zipper on both sides from bottom to top.



When the fabric is firm or densely woven, it is recommended to use a needle with the size 90 – 100. This results in an even stitch formation.



- > Fit the Reverse Pattern Foot #1C.
- > Tap «Practical Stitches».
- > Select Straight Stitch No. 1.
- > Sew the seam up to where the zipper starts.
- > Sew the securing stitches.
- > Close the zipper length with long stitches.
- > Finish the seam allowances.
- > Iron the seam.
- > Open the zipper length.
- > Baste the zipper under the fabric so that the fabric folded edges meet over the center of the zipper.
- > Fit the Zipper Foot #4D.
- > Move the needle position to the right.
- > Use the Free Hand System to raise the presser foot and to position the sewing project.
- > Start sewing in the center of the seam at the end of the zipper.
- > Sew diagonally along the edge of the zipper coils.
- > Sew the first side (1) from bottom to top.
- > Stop in front of the zipper pull with needle position down.
- > Raise the presser foot.
- > Open the zipper as far as behind the presser foot.
- > Lower the presser foot and continue sewing.
- > Move the needle position to the left.
- > Sew the second side (2) in exactly the same way from bottom to top.



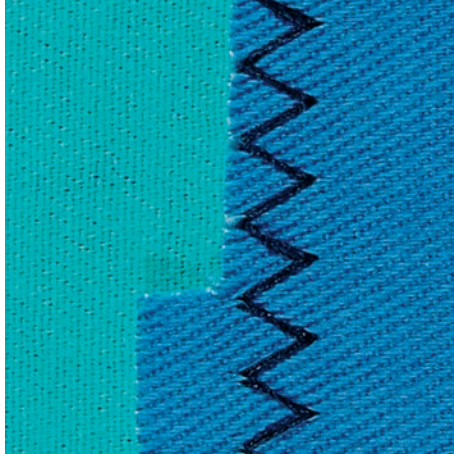
## 6.6 Sewing Triple Straight Stitch



The triple straight stitch is especially suitable for durable seams and for firm, densely woven fabrics such as denim and corduroy. For firm or densely woven materials, it is recommended to fit the Jeans Foot #8. This will help to sew denim or canvas. For decorative topstitching, the stitch length can be elongated.

- > Fit the Reverse Pattern Foot #1C/1D.
- > Tap «Practical Stitches».
- > Select Triple Straight Stitch No. 6.

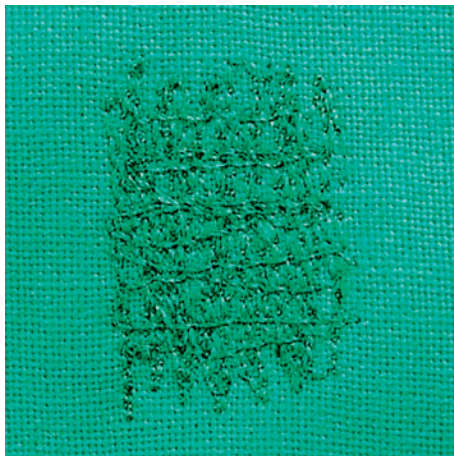
## 6.7 Sewing Triple Zigzag



In firm fabrics, particularly for denim fabrics, deckchair covers, awnings. Hems on items that are frequently washed. Finish the seam edges first.

- > Fit the Reverse Pattern Foot #1C/1D.
- > Tap «Practical Stitches».
- > Select Triple Zig zag No. 7.

## 6.8 Manual Darning

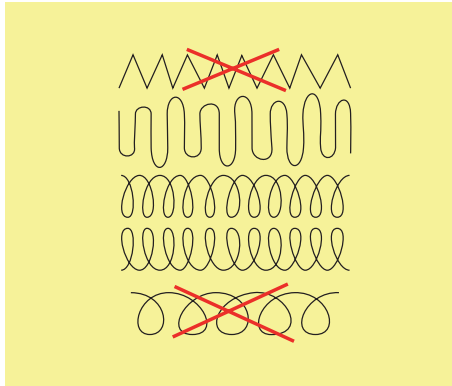


Used for darning holes or worn areas in all fabric types.

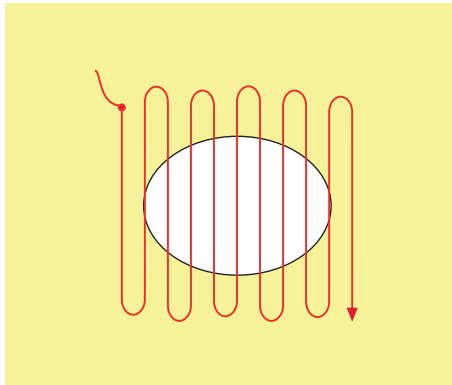
If the thread is lying on top and a poor stitch formation results, slow down the movement of the sewing project. If there are knots on the wrong side of the fabric, move the sewing project faster. When the thread breaks, guide the sewing project more consistently.

- > Fit the Darning Foot #9.
- > Tap «Practical Stitches».
- > Select Straight Stitch No. 1.
- > Lower the feed dog.
- > Attach the Slide-on Freearm Extension Table.

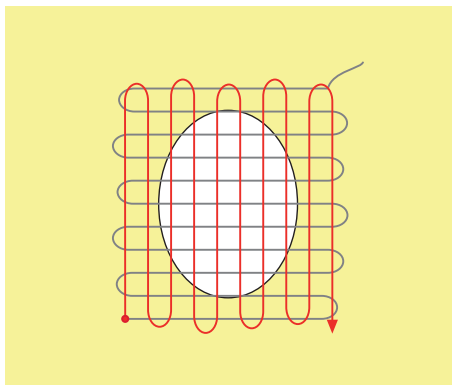
- > Hoop the sewing project in the round embroidery hoop (optional accessory).
  - The darning area stays evenly taut and cannot be distorted.
- > Sew from the left to the right, guide the fabric evenly by hand without using pressure.
- > Move in curves when changing the direction to avoid holes and thread breakage.
- > Work the edges in irregular lengths so that the thread is better spread over the fabric.



- > Sew the first rows not too close together and beyond the worn area.
- > Sew the rows in irregular lengths.

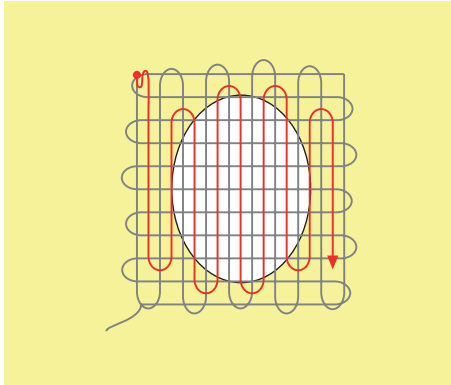


- > Turn the sewing project by 90°.
- > Sew the first rows not too close.



- > Turn the sewing project by 180°.

- > Sew another loose row.



## 6.9 Automatic Darning



The Simple Darning Program No. 22 is particularly suitable for quick darning of worn areas or tears. It is recommended to use fine material as a backing for the worn and damaged areas or to stick an adhesive interlining. The Simple Darning Program No. 22 replaces the longitudinal threads in all fabrics. If the darning area becomes distorted, correct with the balance.

- > Fit the Reverse Pattern Foot #1C or Buttonhole Foot with Slide #3A.
- > Tap «Practical Stitches».
- > Select Simple Darning Program No. 22.
- > Hoop light-weight materials in the round embroidery hoop (optional accessory).
  - The darning area stays evenly taut and cannot be distorted.
- > Start sewing top left.
- > Sew the first row.
- > Stop the machine.
- Ⓡ > Push the button «Quick Reverse».
  - The length is programmed.
- > Finish sewing the Darning Program.
  - The machine stops automatically.

## 6.10 Reinforced Darning, Automatic



The Reinforced Darning Program No. 23 is particularly suitable for quick darning of worn areas or tears. The Reinforced Darning Program No. 23 replaces the longitudinal threads in all fabrics.

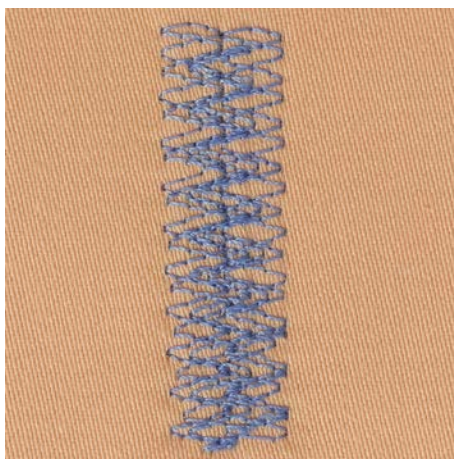


If the Darning Program does not cover the whole worn or damaged area, it is recommended to reposition the work and sew the Darning Program again. The length is programmed and can be repeated as often as desired.



- > Fit the Buttonhole Foot with Slide #3A.
- > Tap «Practical Stitches».
- > Select Reinforced Darning Program No. 23.
- > Hoop light-weight materials in the round embroidery hoop (optional accessory).
  - The darning area stays evenly taut and cannot be distorted.
- > Start sewing top left.
- > Sew the first row.
- > Stop the machine.
- ⏪ > Push the button «Quick Reverse».
  - The darning length is programmed.
- > Finish sewing the Darning Program.
  - The machine stops automatically.

## 6.11 Reinforced Darning



The Darning Stitch No. 34 is particularly suitable for damaged areas on heavy or strong fabrics, e. g. jeans and work clothes.

- > Fit the Reverse Pattern Foot #1C.

- > Tap «Practical Stitches».
- > Select Darning Stitch No. 34.
- > Sew the first row. Start at the top left.
- U
  - > When the desired length is reached, push the button «Quick Reverse».
  - The machine sews in reverse.
- U
  - > When the desired length is reached, push the button «Quick Reverse» again.
  - > Repeat the process until the desired width is filled.

## 6.12 Finishing Edges



Zigzag No. 2 is suitable for all fabrics. It can be used for elastic seams as well as for decorative work. Use darning thread for fine materials. When sewing satin stitch, it is recommended to set a short, dense zigzag at a stitch length of 0.3 – 0.7 mm. The satin stitch can be used for appliqué and for embroidering.

Prerequisite:

- The edge of the fabric should lie flat and not roll.

- > Fit the Reverse Pattern Foot #1C.
- U
  - > Tap «Practical Stitches».
  - > Select Zigzag No. 2 or Satin Stitch No. 1315.
  - > Neither select too wide a stitch nor too long a stitch.
  - > Guide the edge of the fabric into the center of the presser foot, so that the needle goes into the fabric on one side and over the edge into the air on the other side.

## 6.13 Sewing Double Overlock



A double overlock seam is suitable for loose knits and cross seams in knits. When working with jersey, a jersey needle should be used to prevent damaging the knit fabric. When sewing stretch materials, use a stretch needle.

- > Fit the Reverse Pattern Foot #1C or Overlock Foot #2A.



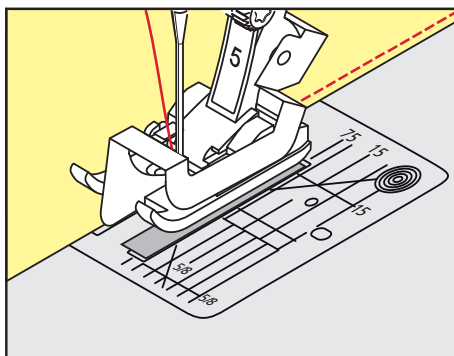


- > Tap «Practical Stitches».
- > Select Double Overlock No. 10.

### 6.14 Narrow Edgestitching



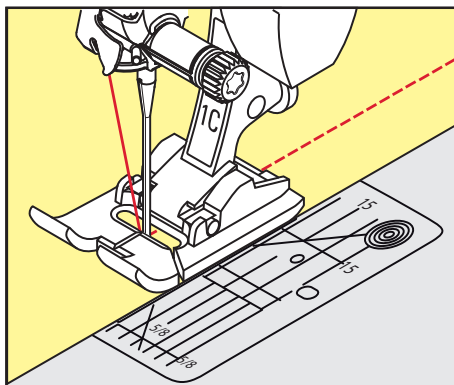
- > Fit the Blindstitch Foot #5 or Edgestitch Foot #10/10C/10D.
- > Tap «Practical Stitches».
- > Select Straight Stitch No. 1.
- > Place the edge against the left-hand guide of the Blindstitch Foot.
- > Select the left-hand needle position at the desired distance to the edge.



### 6.15 Wide Edgestitching



- > Fit the Reverse Pattern Foot #1C.
- > Tap «Practical Stitches».
- > Select Straight Stitch No. 1.
- > Guide the edge along the presser foot or at a distance of 1 – 2.5 cm along the marks on the stitch plate.
- > Select the needle position at the desired distance to the edge.



### 6.16 Edgestitching Using the Seam Guide

When sewing parallel wider lines, it is recommended to guide the seam guide along the sewn of lines.

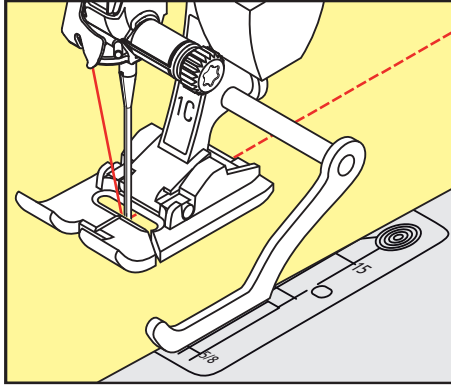


- > Fit the Reverse Pattern Foot #1C.
- > Tap «Practical Stitches».
- > Select Straight Stitch No. 1.
- > Loosen the screw on the back of the presser foot.
- > Insert the seam guide into the hole in the presser foot.
- > Adjust the width as required.
- > Tighten the screw.





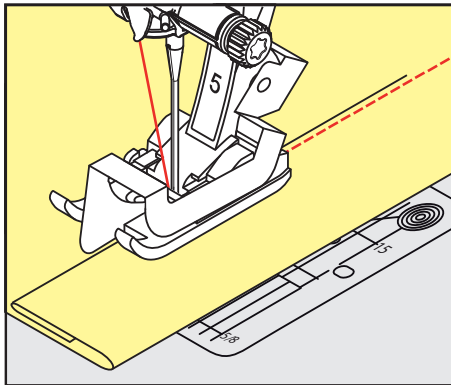
- > Guide the folded edge along the seam guide.



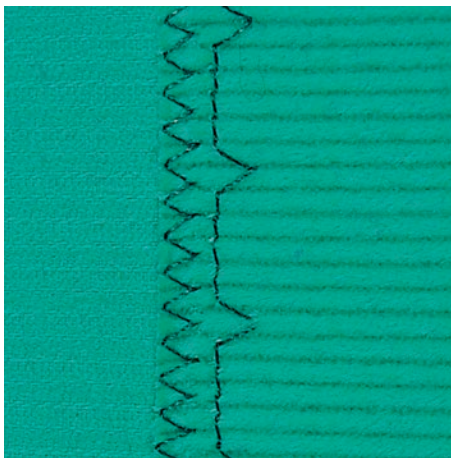
## 6.17 Sewing Hem Edges

When using the Blindstitch Foot #5, it is recommended to set the needle position to the far left or right. With the Reverse Pattern Foot #1C and Edgestitch Foot #10/10C/10D all needle positions are possible.

- > Fit the Blindstitch Foot #5 or the Reverse Pattern Foot #1C or the Edgestitch Foot #10/10C/10D.
- > Tap «Practical Stitches».
- > Select Straight Stitch No. 1.
- > Place the inner upper hem edge against the guide of the Blindstitch Foot on the right.
- > Select the needle position to the far right in order to sew along the upper edge.



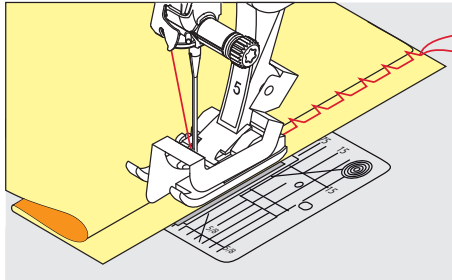
## 6.18 Sewing Blind Hems



For invisible hems in medium to heavy weight cotton, wool and blended materials.

Prerequisite:

- The fabric edges are finished.
- > Fit the Blindstitch Foot #5.
- > Tap «Practical Stitches».
- > Select Blind Stitch No. 9.
- > Fold the fabric so that the finished fabric edge is on the right side.
- > Place the fabric under the presser foot and move the folded edge against the metal guide on the presser foot.
- > Guide the folded edge evenly along the metal guide of the presser foot to sew the stitches evenly deep.
  - Make sure that the needle only pierces the edge of the fold.
- > After sewing about 10 cm, check both sides of the fabric and adjust the width again if necessary.



## 6.19 Sewing Visible Hems

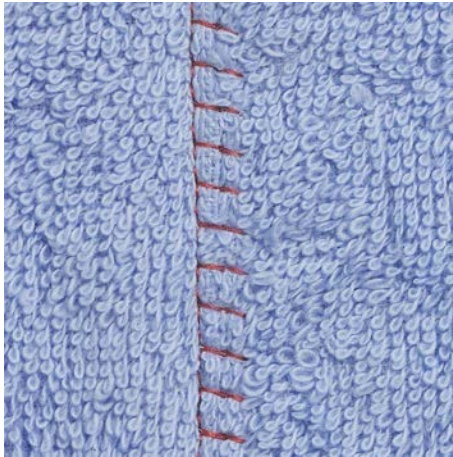


The visible hem is particularly suitable for elastic seams in tricot made of cotton, wool, synthetic and mixed fibers.

- > Fit the Reverse Pattern Foot #1C/1D.
- > Tap «Practical Stitches».
- > Select Tricot Stitch No. 14.
- > Iron the hem and baste if necessary.
- > Reduce the presser foot pressure if necessary.
- > Sew the hem in the desired depth on the right side of the fabric.
- > Trim off the remaining fabric on the wrong side of the fabric.



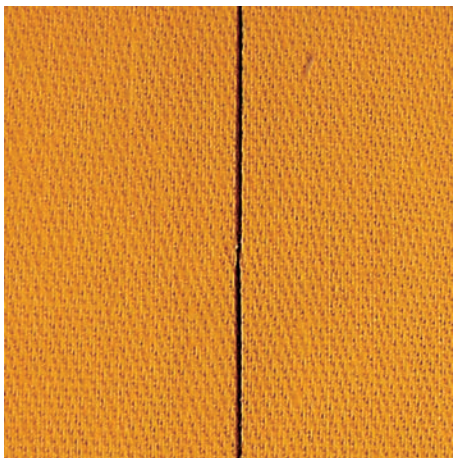
## 6.20 Sewing Flat Joining Seams



The flat joining seam is especially suitable for long-pile or thick materials such as terrycloth, felt or leather.

- > Fit the Reverse Pattern Foot #1C.
- > Tap «Practical Stitches».
- > Select Stretch Overlock No. 13.
- > Overlap the fabric edges.
- > Sew along the fabric edge.
- > To get a very flat, durable seam, make sure the needle stitches right over the top edge of the fabric into the bottom fabric.

## 6.21 Sewing Basting Stitches



When sewing basting stitches, it is recommended to use a fine darning thread. This is easier to remove. With the Basting Stitch No. 21, every fourth stitch is sewn. The longest stitch comes up to 24 mm when a stitch length of 6 mm is selected. The recommended stitch length is 3.5 – 5 mm. The Basting Stitch is suitable for sewing projects where a very long stitch length is required.

- > Fit the Reverse Pattern Foot #1C/1D.
- > Tap «Practical Stitches».
- > Select Basting stitch No. 21.
- > Select the stitch length.
- > Pin the fabric layers at a right angle to basting direction to prevent the layers from slipping.
- > Sew 3 – 4 securing stitches at the start and at the end.

## 7 Decorative Stitches

### 7.1 Overview Decorative Stitches

Easier or more difficult decorative stitches come into their own depending on the type of fabric.

- Decorative stitches which are programmed with single straight stitches are particularly appropriate for lightweight materials, e. g. Decorative StitchNo. 101
- Decorative stitches which are programmed with triple straight stitches or with a few satin stitches are particularly appropriate for medium-weight materials, e. g. Decorative Stitch No. 107.
- Decorative stitches which are programmed with satin stitches are particularly appropriate for heavyweight materials, e. g. Decorative StitchNo. 401

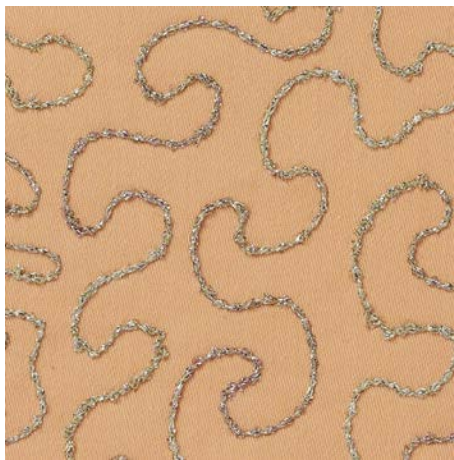
For a perfect stitch formation, it is of advantage to use the same thread color for upper and bobbin thread and a stabilizer. With pile or longfiber materials, it is recommended to use an additional water-soluble stabilizer, which can be easily removed after sewing, on the right side of the fabric.



Decorative Stitch	Category	Name
	Category 100	Nature Stitches
	Category 200	Nature Stitches with Sideways Motion
	Category 300	Cross Stitches
	Category 400	Satin Stitches
	Category 500	Satin Stitches with Sideways Motion
	Category 600	Geometric Stitches
	Category 700	Heirloom Stitches
	Category 800	Heirloom Stitches with Sideways Motion
	Category 900	Children Stitches

Decorative Stitch	Category	Name
	Category 1000	Children Stitches with Sideways Motion
	Category 1200	Filigree Stitches with Sideways Motion
	Category 1400	Tapering
	Category 1500	Skyline Stitches (Special Stitches)
	Category 1600	Quilt Stitches Sideways Motion
	Category 1700	International
	Category 2000	Seasons
	Category 2200	Sport and Hobbies

## 7.2 Bobbin-Play



The bobbin can be filled with different thread material. For free-motion stitching to add texture. This method is similar to “normal” free-motion sewing, but is done on the **wrong** side of the fabric.

Reinforce the area to be sewn with embroidery stabilizer. The design can be drawn on the wrong side of the fabric. You can also draw the design on the front side of the fabric. The lines can be followed with a freely guided straight stitch using polyester, cotton or rayon thread. The rows of stitching are visible on the wrong side of the fabric, and they serve as guidelines for the bobbin-thread sewing.

The BSR function can be used for bobbin-thread sewing. We recommend guiding your project evenly under the needle at a consistent speed, following the lines of the design. The stabilizer must be removed after sewing.

Sew a sample first to check what the result looks like on the wrong side of the fabric.

Not all decorative stitches are suitable for this technique. Simple decorative stitches provide best results. Avoid compact stitch types and satin stitches.

**NOTICE**

**Inappropriate bobbin case is used**

Damage of the bobbin case.

- > Use the special bobbinwork case (optional accessory).

- > Fit the Open Embroidery Foot #20C/20D.



- > Tap «Decorative Stitches».

- > Select an appropriate decorative stitch.

- > Turn the «Upper Multifunction Knob» and the «Lower Multi-function Knob» to set the stitch length and stitch width so that a beautiful stitch formation can be achieved even when sewing with thick thread.



- > Tap «i-Dialog».



- > Tap «Long Stitch».

- Every second stitch is sewn.



- > To adjust the upper thread tension, tap «Upper Thread Tension».

**7.3 Altering the Stitch Density**

With certain decorative stitches (e. g. No. 401) the stitch density can be altered. If the stitch density is increased, the stitch distance is enlarged. If the stitch density is decreased, the stitch distance is shortened. The programmed length of the stitch pattern is not affected.

- > Select the decorative stitch.



- > Tap «i-Dialog».



- > Tap «Altering the Pattern Length/Stitch Density».

- > Set the stitch density (1).



## 7.4 Tapering

### Overview Tapering



- |   |                                       |    |                                |
|---|---------------------------------------|----|--------------------------------|
| 1 | «Programming the Length of Section 2» | 6  | «Manual Tapering»              |
| 2 | «Pattern Repeat»                      | 7  | «Tapering Configuration»       |
| 3 | «Adjusting Lengths»                   | 8  | «Back Stepping»                |
| 4 | «Mirror Image Left/Right»             | 9  | «Save Stitch Pattern Settings» |
| 5 | «Balance»                             | 10 | «Reset Stitch Pattern»         |

### Altering Points of a Stitch Pattern

Tapering is a technique in which the stitch patterns come to a point at the beginning and at the end. A choice of 4 preset stitch pattern tips is available. In addition, the tips of the stitch pattern can also be determined individually.



- > Tap «Decorative Stitches».
- > Select a stitch pattern of the Category 1400.



- > Tap «i-Dialog».



- > Tap «Tapering Configuration».
- > Select the desired point of the stitch pattern in the right portion of the display.



- > To individualize the tips of the stitch pattern, tap «Setting the Stitch Pattern Tips».
- > To alter the tips of the stitch pattern, tap «Minus» in the upper right area of the display or «Plus».

- > To alter the length of the stitch pattern tips, tap «Minus» in the lower right area of the display or «Plus».



### Sewing Tapering

Alterations to the selected stitch pattern are saved automatically. In Manual Mode, the alterations are discarded after the stitch pattern is selected again.



- > Tap «Decorative Stitches».
- > Select a stitch pattern of the Category 1400.



- > Tap «i-Dialog».



- > In order to not save alterations to the stitch pattern, tap «Manual Tapering».



- > In order to save alterations to the stitch pattern automatically, tap «Programming the Length of Section 2».



- > To start sewing, press the button «Start/Stop» or operate the foot control.



- > Press the button «Quick Reverse» as soon as the desired length in the center section of the tapering is reached.
  - The machine sews the whole stitch pattern and stops automatically.

### Sewing tapering automatically



- > Tap «Decorative Stitches».
- > Select a stitch pattern of the Category 1400.



- > Tap «i-Dialog».



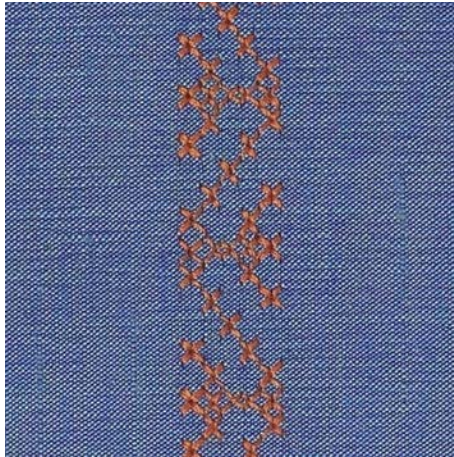
- > Tap «Adjusting Lengths».
- > To adjust the length, turn the «Upper Multi-function Knob» or «Lower Multi-function Knob».



- > To start sewing, press the button «Start/Stop» or operate the foot control.
  - The machine sews the whole stitch pattern and stops automatically.



## 7.5 Sewing Cross Stitches



Cross stitch embroidery is a traditional technique and an addition to the other decorative stitches. If the cross stitches are sewn on fabrics with a linen structure, they look as if they were hand-stitched. When cross stitches are sewn with embroidery yarn, the stitch pattern appears fuller. Cross stitches are particularly used for home furnishing, trimmings on garments and embellishing in general. As every following line refers to the first row, it is important to stitch the first row in a straight line.

- > Fit the Reverse Pattern Foot #1C/1D or Open Embroidery Foot #20C/20D.
- > Select a cross stitch of the Category 300 and combine it as desired.
- > Stitch the first row using the seam guide to sew a straight line.
- > Stitch the second row next to the first at a distance of one presser foot's width or using the seam guide.






## 7.6 Pintucks

### Pintucks



Pintucks are narrow stitched folds, which are normally sewn on the fabric before cutting out the pieces for the garment or the sewing project. They are suitable for embellishing or in combination with other heirloom embroidery techniques. The use of Pintuck Feet can simplify this technique considerably. The technique reduces the size of the fabric piece. It is always advisable to plan in sufficient fabric.

## Overview Pintuck Feet

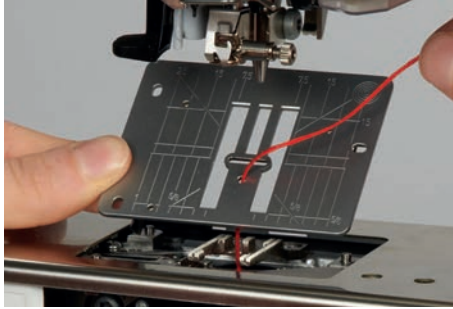
Pintuck Foot	Number	Description
	# 30 (optional accessory)	3 grooves For heavy-weight fabrics. In combination with the 4 mm twin needle
	# 31 (optional accessory)	5 grooves For heavy to medium-weight fabrics. In combination with the 3 mm twin needle
	# 32 (optional accessory)	7 grooves For light to medium-weight fabrics. In combination with the 2 mm twin needle
	# 33 (optional accessory)	9 grooves For very light fabrics (without extra cord). In combination with the 1 or 1.6 mm twin needle
	# 46C (optional accessory)	5 grooves In combination with the 1.6 – 2.5 mm twin needle For very light to medium-weight fabrics.

### Working with Cord

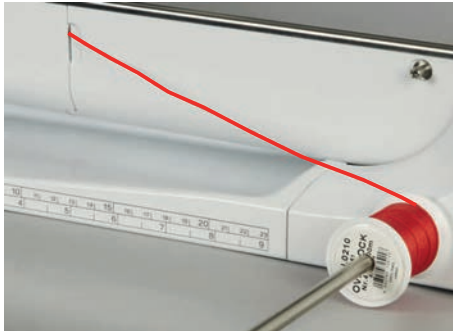
The pintucks look more distinctive and relief-like when they are sewn with a supplementary cord. Choose a cord that fits well into the grooves of the respective foot. The cord must be colorfast and shrink-proof.

- > Switch off the machine.
- > Remove the needle.
- > Remove the presser foot.
- > Remove the stitch plate.
- > Open the hook cover.
- > Pull the cord through the hook opening from the bottom and through the opening of the stitch plate.
- > Replace the stitch plate.
- > Close the hook cover.

- > Make sure that the cord slides through the thread slot of the bobbin cover.



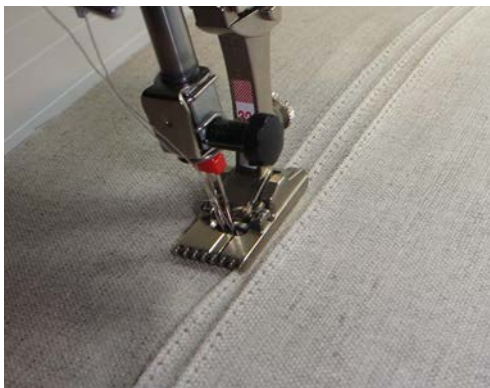
- > Place the spool on the knee lifter.



- > Check that the cord runs smoothly.
- > If the thread doesn't glide smoothly at the hook cover, leave the hook cover open.
- > If the hook cover is opened, deactivate the lower thread indicator in the Setup Program.
  - The cord lies on the wrong side of the material and is hold/sewn over by the bobbin thread.

### Sewing Pintucks

- > Insert the corresponding twin needle.
- > Threading the double needle.
- > Thread-up command.
- > Sewing the first pintuck.
- > Place the first pintuck in one of the side grooves in the presser foot.
- > Sew additional pintucks parallel.



## 8 Alphabets and Monograms

### 8.1 Overview Alphabets

Block, Outline, and Script lettering, as well as Cyrillic can be sewn in two different sizes. Monograms can be sewn in three different sizes. Block, Outline, and Script lettering, as well as Cyrillic can also be sewn in lower-case letters.

For a perfect stitch formation, it is recommended to use the same thread color for upper and bobbin threads. The fabric can be reinforced with embroidery stabilizer on the wrong side. When working with pile or napped fabrics, e.g. toweling, use an additional, water-soluble stabilizer on the right side of the fabric.



Stitch Pattern	Name
ABCabc	Block alphabet
ABCabc	Double-Block
<i>ABCabc</i>	Script (Italics)
ABCabc	Comic lettering
<i>ABC</i>	Monograms 30/20/15 mm
ABCabc	Quilting text
あいう	Hiragana
アイウ	Katakana
АБВабв	Cyrillic
<i>АБВ абв</i>	Cyrillic script

## 8.2 Creating Lettering



When sewing Sideways Motion patterns, for example monograms, it is recommended to use the Sideways-motion Foot #40C. Sewing a test sample with the thread, the actual fabric and stabilizer you intend to use is recommended. Make sure that the fabric is fed evenly and lightly, ensuring that it cannot push against or catch on anything. The fabric shouldn't be pulled, pushed or held back.







- > Tap «Alphabets».
- > Select the font.



- > To create a combination, tap «Combination Mode/Single Mode».
- > To open the extended Enter Mode, tap «Increasing/Decreasing the Display Size» (1).



- > Select the letters.
-  > To use upper-case letters, tap «Upper Case Characters» (standard setting).
-  > To use lower-case letters, tap «Lower Case Characters».
-  > To use figures and mathematical symbols, tap «Numbers and Mathematical Characters».
-  > To use special characters, tap «Special Characters».



- > To delete individual syllables of the entered text, tap «Deleting».
- > To close the extended Enter Mode, tap «Increasing/Decreasing the Display Size» again.

## 8.3 Altering Font Size

Block, outline, script, comic, and Cyrillic fonts can be scaled down in Single Mode.



- > Tap «Alphabets».
- > Select the font.
- > Select the letters.



- > Tap «i-Dialog».



- > To reduce the font size, tap «Alter Font Size».
- > To scale up the font size to 9 mm, tap «Alter Font Size» again.

## 8.4 Altering Size of Monogram

The font size is preset to 30 mm. The letters can be scaled down to 20 mm or 15 mm.

Prerequisite:

- A single letter is selected.



> Tap «i-Dialog».













- > To reduce the font size to 20 mm, tap «Altering Size of Monogram».
- > To reduce the font size to 15 mm, tap «Altering Size of Monogram» again.
- > To scale up the font size to 30 mm, tap «Altering Size of Monogram» again.











## 9 Buttonholes

### 9.1 Overview Buttonholes

To be able to create the right buttonhole for every button, every purpose and also for every garment, the BERNINA 790 PRO comes with an extensive collection of buttonholes. The corresponding button can be sewn on automatically. Eyelets can also be sewn.



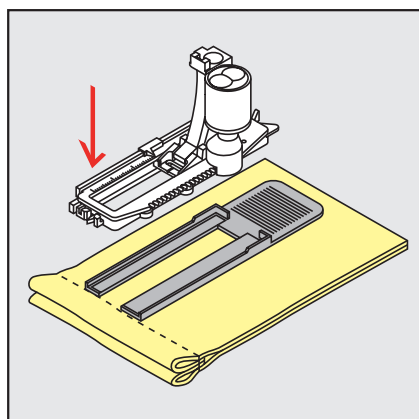
Stitch patterns	Stitch number	Name	Description
	51	Standard Buttonhole	For light to medium-weight fabrics. e.g. blouses, dresses and bed linen.
	52	Narrow Standard Buttonhole	For light to medium-weight fabrics, e.g. blouses, dresses, children's and baby clothes, crafts.
	53	Stretch Buttonhole	For all elastic fabrics.
	54	Round Buttonhole with Normal Bartack	For medium-weight to heavy fabrics. e.g. dresses, jackets, coats and rainwear.
	55	Round Buttonhole with Horizontal Bartack	For medium-weight to heavy fabrics, with a reinforced bar, e.g. dresses, jackets, coats and rainwear.
	56	Keyhole Buttonhole	For heavy, non-stretch fabrics, e.g. jackets, coats and leisurewear.
	57	Keyhole Buttonhole with Pointed Bartack	For stronger, non-stretch fabrics, e.g. jackets, coats, jeans and leisurewear.
	58	Keyhole Buttonhole with Horizontal Bartack	For strong, non-stretch fabrics, e.g. jackets, coats and leisurewear.
	59	Straight Stitch Buttonhole	For staystitching and reinforcing buttonholes and as button hole edging, especially for buttonholes in leather and imitation leather.
	60	Button Sew-on Program	Sews buttons with 2 or 4 holes.

Stitch patterns	Stitch number	Name	Description
	61	Eyelet with Small Zigzag	Openings for cords or narrow ribbons and for decorative work.
	62	Eyelet with Straight Stitch	Openings for cords or narrow ribbons and for decorative work.
	63	Heirloom Buttonhole	For handlook stitching effects on clothes and handicrafts on light to medium-weight fabrics.
	64	Double-rounded Buttonhole	For medium-weight to heavy fabrics made from different fabrics.
	65	Double-rounded Heirloom Buttonhole	For light to medium-weight woven fabrics, e.g. blouses, dresses and bedlinen.
	66	Narrow buttonhole with double pointed bartack	For decorative buttonholes in medium-weight fabrics, e.g. dresses and jackets.
	67	Round Buttonhole with Bartack	For medium-weight woven fabrics, e.g. blouses, dresses and jackets.
	68	Decorative keyhole buttonhole with horizontal bartack	For stronger, non-stretch fabrics, e.g. jackets, coats and leisurewear.
	69	Decorative Buttonhole with Double Pointed Bartack	For decorative buttonholes in firmer, non-elastic fabrics.
	70	Decorative stretch buttonhole	For decorative buttonholes in light to medium-weight knitted fabrics.

## 9.2 Making Use of the Height Compensation Tool

When a buttonhole is to be sewn at right angles to the project edge, it is recommend to use the height compensation plates (optional accessory).

- > Place the plates from the back between the sewing project and the bottom of the slide to the thick part of the sewing project.



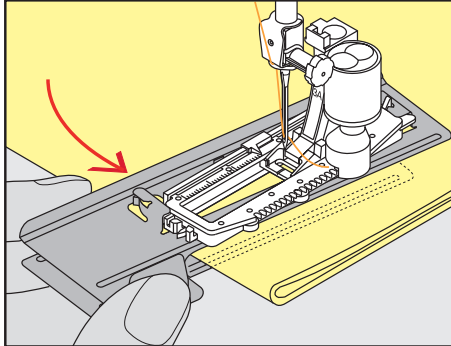
- > Lower the presser foot.



### 9.3 Using the Compensation Plate

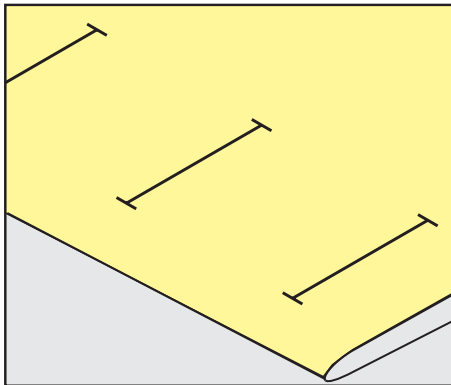
For sewing a buttonhole in problematic fabrics, it is recommended to use the Height Compensation Tool (optional accessory). The Height Compensation Tool can be used in combination with the Buttonhole Foot with Slide #3A.

- > Insert the compensation plate carefully from the side.

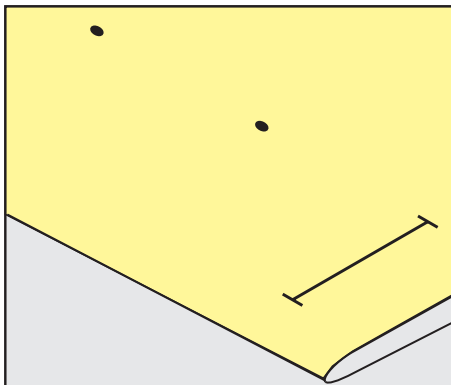


### 9.4 Marking Buttonholes

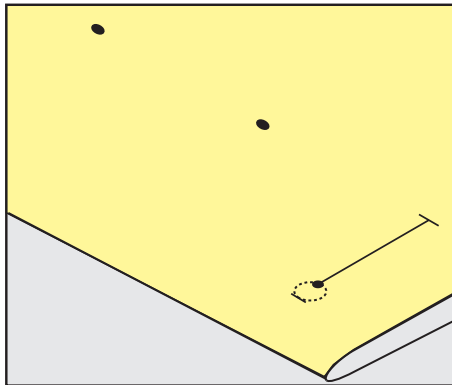
- > For the buttonholes to be sewn manually, mark the position and the length on the fabric using chalk or a water-soluble pen.



- > For the buttonholes to be sewn automatically, mark the complete length of 1 buttonhole on the fabric using chalk or a water-soluble pen. For any subsequent buttonholes mark the starting point.



- > For keyhole and round buttonholes mark the length of the bead with chalk or a water-soluble pen on the fabric. For any subsequent buttonholes mark the starting point. The length of the keyhole is sewn additionally.



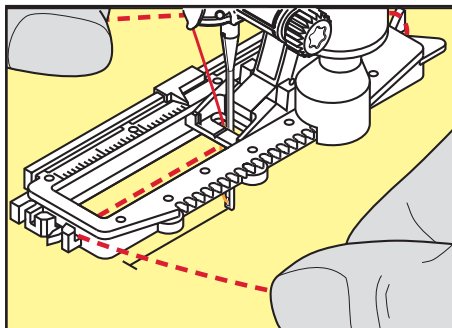
## 9.5 Cord

### Using Cord with the Buttonhole Foot with Slide #3A

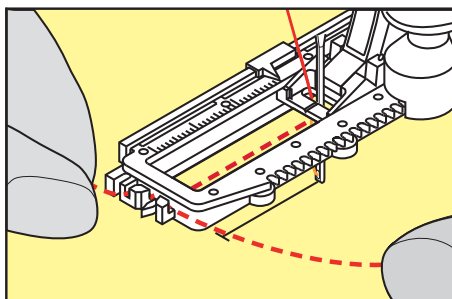
The additional cord reinforces and embellishes the buttonhole and is particularly suitable for the Buttonhole No. 51. Ideal cords are Perle cotton No. 8, strong hand-sewing thread and fine crochet yarn. It is recommended to not hold the cord while sewing.

Prerequisite:

- The Buttonhole Foot with Slide #3A is fitted and raised.
- > Insert the needle at the beginning of the buttonhole.
- > Guide the cord on the right side under the Buttonhole Foot with Slide.
- > Hook the cord over the pin at the back of the Buttonhole Foot with Slide.

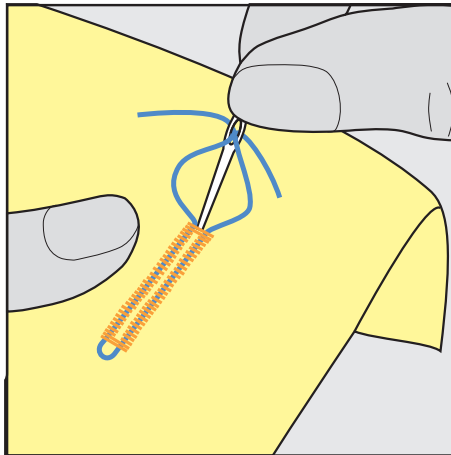


- > Pull the cord on the left side under the Buttonhole Foot with Slide to the front.



- > Pull the cord ends into the slits.
- > Lower the Buttonhole Foot with Slide.
- > Sew the buttonhole in the usual manner.
- > Pull the cord loop until the loop disappears in the bartack.

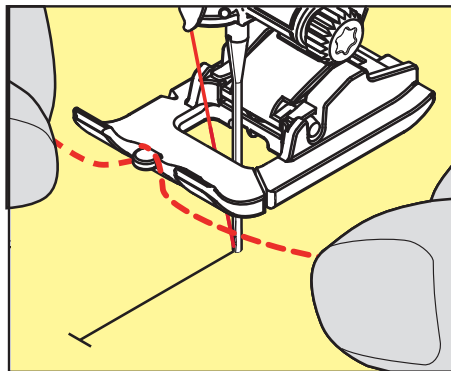
- > Pull the ends of the cord through to the wrong side of the fabric (using a hand sewing needle) and knot or secure them with stitches.



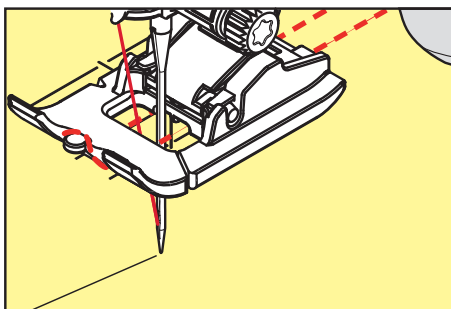
### Using Cord with the Buttonhole Foot #3C

Prerequisite:

- The Buttonhole Foot #3C is fitted and raised.
- > Insert the needle at the beginning of the buttonhole.
- > Hook the cord over the center pin at the front of the Buttonhole Foot.

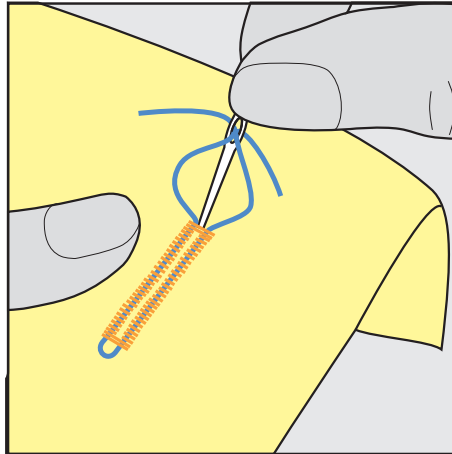


- > Pull both cords ends under the Buttonhole Foot to the back and place each a cord into a groove of the sole.



- > Lower the Buttonhole Foot.
- > Sew the buttonhole in the usual manner.
- > Pull the cord loop until the loop disappears in the bartack.

- > Pull the cord ends with the sewing needle to the back and knot or secure them.



## 9.6 Sewing a Test Sample

Always sew a test sample of the buttonhole on the same fabric: It is recommended to use the same stabilizer and to select the same buttonhole. The test sample should also be sewn in the respective direction. By sewing a test sample the settings can be adjusted until the sewing result is satisfying.

It is worth underlaying the buttonholes with the Straight Stitch Buttonhole No. 59 when working with soft loosely woven materials and for buttonholes which are severely strained. This is also recommended to reinforce buttonholes in leather, vinyl or felt.

Alterations of the Balance when sewing a manual standard buttonhole as well as the Keyhole and the Round Buttonhole affect both beads in the same way. With the manual keyhole or round buttonhole, the alterations affect both sides in the opposite way.

If the Stitch Counter function is used, and alterations are made concerning the Balance, the alterations affect both buttonhole beads differently.



- > Tap «Buttonholes».
- > Select the buttonhole.
- > Select and fit the desired presser foot.
- > Place the fabric under the presser foot and lower the presser foot.
- > Press the foot control carefully and start sewing. Guide the fabric slightly.
- > Check the Balance while sewing and adjust if necessary.
- > Check the test sample and make further amendments if necessary.

## 9.7 Determining the Buttonhole Slit Width

The width of the buttonhole slit can be adjusted between 0.1 – 2.0 mm before sewing.



- > Tap «Buttonholes».
- > Select the buttonhole.



- > Tap «i-Dialog».



- > Tap «Buttonhole Slit Width».
- > To adjust the desired width of the buttonhole slit, turn the Upper Multi-function Knob or the «Lower Multi-function Knob».

## 9.8 Determining the Buttonhole Length with the Buttonhole Foot with Slide #3A



The button can be centered in the yellow circle in the lower portion of the display. The yellow circle can be enlarged or downsized with the «Multifunctional knobs up/down» and the diameter of the button can be determined in this way.

2 mm is automatically added to the diameter of the button for the buttonhole length. If the diameter of the button is 14 mm, for example, 16 mm is calculated for the buttonhole length.

Prerequisite:

- The Buttonhole Foot with Slide #3A is fitted.



- > Tap «Buttonholes».
- > Select the buttonhole.



- > Tap «i-Dialog».



- > Tap «Direct Entry Buttonhole Length».
- > To adjust the buttonhole length, turn the «Upper Multi-function Knob» or the «Lower Multi-function Knob».

## 9.9 Determining the buttonhole length with Buttonhole Foot #3C

When the Buttonhole Foot #3C is used, the buttonhole length must be determined via the function Stitch Counter. The stitch counter function is suitable for all types of buttonholes. The left buttonhole bead is sewn forward, the right buttonhole bead is sewn in reverse. If alterations are made to the balance, the stitch counter function has to be saved for every buttonhole separately.

Prerequisite:

- The Buttonhole Foot #3C is fitted.



- > Tap «Buttonholes».
- > Select the buttonhole.



- > Tap «i-Dialog».

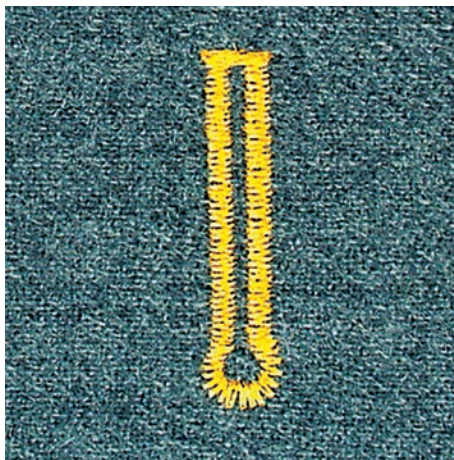
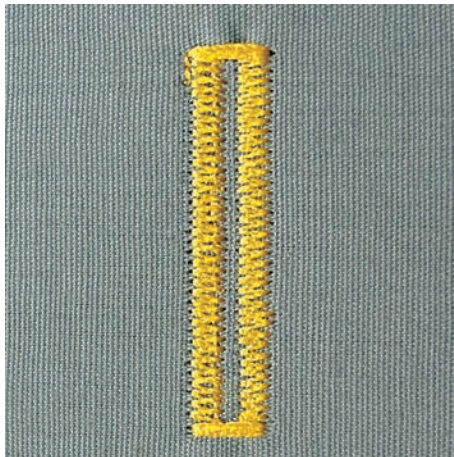


- > Tap «Programming the Length via the Stitch Counter».
- > Sew the desired length of the buttonhole.
- > Stop the machine.



- > The machine sews the lower bartack and the second bead in reverse when the button «Quick Reverse» is pushed.
- > Stop the machine at the height of the first stitch.
- > The machine sews the upper bartack and the securing stitches when the button «Quick Reverse» is pushed again.
  - The length of the buttonhole remains saved and every subsequent buttonhole is sewn identically until the machine is switched off.

## 9.10 Sewing a Buttonhole Automatically



When the Buttonhole Foot with Slide #3A is used, the length of the buttonhole is measured automatically by the lens on the presser foot. The buttonhole will be exactly duplicated and the machine switches to the next step automatically when the maximum length is reached. The Buttonhole Foot with Slide #3A is suitable for buttonholes at a length of 4 – 31 mm, depending on the buttonhole type. The Buttonhole Foot with Slide #3A must lie perfectly flat on the fabric so that the length can be measured accurately. Programmed buttonholes are all at the same length and of the same nice look.

Prerequisite:

- The Buttonhole Foot with Slide #3A is fitted.



- > Tap «Buttonholes».
- > Select the Buttonhole No. 51 – 53 or 54 – 58 or No. 66, 68 or 69.
- > Sew the desired length of the buttonhole.



- > To program the length, push the button «Quick Reverse».



- > Push the button «Start/Stop» or press the foot control.
  - The machine finishes the buttonhole automatically. All subsequent buttonholes are sewn at the same length.

## 9.11 Programming the Heirloom Buttonhole

Prerequisite:

- The Buttonhole Foot with Slide #3A is fitted.



- > Tap «Buttonholes».
- > Select Heirloom Buttonhole No. 63.
- > Sew the desired length of the buttonhole.

- > To program the length, push the button «Quick Reverse».
  - The machine finishes the buttonhole automatically. All subsequent buttonholes are sewn at the same length.

## 9.12 Sewing the Manual 7-step Buttonhole

The length of the buttonhole is determined manually when sewing. The bartack, eye and securing stitches are preprogrammed. The individual steps can be selected by scrolling with the arrow icons, by direct selection or by pressing the button «Quick Reverse».

Prerequisite:

- The Buttonhole Foot with Slide #3A is fitted.



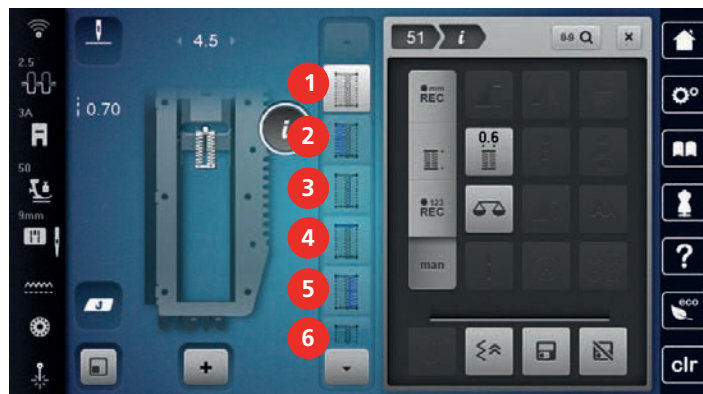
- > Tap «Buttonholes».
- > Select Standard Buttonhole No. 51.



- > Tap «i-Dialog».



- > Tap «Manual Length Adjustment».
  - Step 1 is activated in the display to start the buttonhole.
- > Sew the desired length of the buttonhole.
  - Step 2 becomes active when sewing starts.



- > Stop when the required length of the buttonhole or the length marking is reached.
- > Step 3 appears by tapping «Scroll Down».
  - The machine sews straight stitches in reverse.
- > Stop the machine at the level of the first stitch at the start of the buttonhole.
- > Step 4 appears by tapping «Scroll Down».
  - The machine sews the upper bartack and stops automatically.
- > Step 5 appears by tapping «Scroll Down».
  - The machine sews the second bead.
- > Stop the machine at the level of the last stitch of the first bead.
- > Step 6 appears by tapping «Scroll Down».
  - The machine sews the lower bartack and stops automatically.
- > Step 7 appears by tapping «Scroll Down».
  - The machine secures and stops automatically.

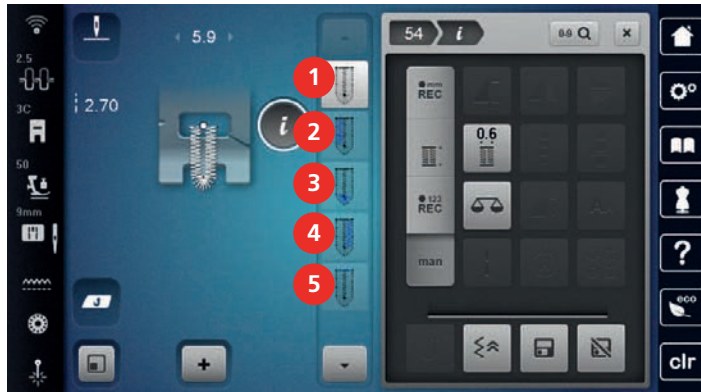
## 9.13 Sewing the Manual 5-step Buttonhole

The length of the buttonhole is determined manually when sewing. The bartack, eye and securing stitches are preprogrammed. The individual steps can be selected by scrolling with the arrow icons, by direct selection or by pressing the button «Quick Reverse».

Prerequisite:

- The Buttonhole Foot with Slide #3A is fitted.

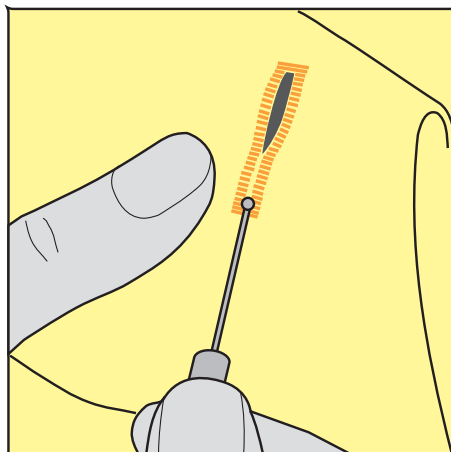
- > Tap «Buttonholes».
- > Select Round Buttonhole with Normal Bartack No. 54.
- > Tap «i-Dialog».
- > Tap «Manual Length Adjustment».
  - Step 1 is activated in the display to start the buttonhole.
- > Sew the desired length of the buttonhole.
  - Step 2 is activated.



- > Stop when the required length of the bead or the length marking is reached.
- > Step 3 appears by tapping «Scroll Down».
- > The machine sews the curve or the eye and stops automatically.
- > Step 4 appears by tapping «Scroll Down».
  - The machine sews the second bead in reverse.
- > Stop the machine at the level of the first stitch where the buttonhole begins.
- > Step 5 appears by tapping «Scroll Down».
  - The machine sews the upper bartack and secures automatically.

### 9.14 Cutting the Buttonhole Open with the Seam Ripper

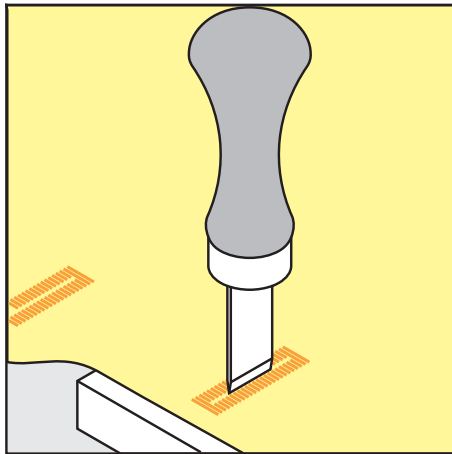
- > Place a pin in each end of the buttonhole to avoid accidental cutting into ends of buttonhole.
- > Cut the buttonhole from both ends to the middle.





## 9.15 Cutting Open Buttonholes with the Buttonhole Cutter (Optional Accessory)

- > Place the fabric on an appropriate wood.



- > Position the cutter in the center of the buttonhole.
- > Press down on the cutter with your hand.

## 9.16 Sewing on a Button

The Button sew-on Program can be used to sew on buttons with two or four holes, press studs or snap fasteners.

Recommended sewing program: Button Sew-on Program No. 60

Recommended presser foot : Button Sew-On Foot #18

Alternative presser feet:

- Reverse Pattern Foot #1/1C
- Darning Foot #9
- Reverse Pattern Foot with Clear Sole #34/34C

### Adjusting the Thread Shank

For buttons on thicker fabrics, increase the thread shank = the distance between the button and the fabric. Buttons sewn on thin fabrics or buttons for decorative purposes only are stitched without a «thread shank».

**NOTICE! The adjustment of the thread shank is only possible when using the Button Sew-On Foot #18.**

- > Loosen the screw on the back of the presser foot.
- > Push the bar upwards according to the thickness of the fabric.
- > Tighten the screw.

### Sewing on a Button

Prerequisite:

- The shank length is adjusted according the fabric thickness.
- The Button Sew-On Foot #18 or an alternative presser foot is fitted.
- The fitted presser foot has been selected in the user interface.
- The feed dog is lowered.



- > Tap «Buttonholes».
- > Select Button Sew-on Program No. 60.
- > Turn the handwheel until the bobbin thread comes up.

- > **NOTICE! The Button sew-on program always starts above the left hole of the button.**  
Position the button on the fabric. Place the button and the fabric beneath the needle so that the needle stitches into the left hole.  
For buttons with 4 holes, sew the first front pair of holes first.
- > Lower the presser foot.
- > Perform the first stitches in the left hole via the handwheel.
- > Keep turning the handwheel until the needle changes to the right hole. In doing so, check whether the needle goes into the right hole. If necessary, adjust the stitch width by turning the upper Multifunction knob.
- > Hold the threads and push the foot control.
  - The machine sews on the button and stops automatically.
- > For increased stability, sew the Button sew-on Program again.
- > Cut the threads with the machine. Alternatively, pull the sewing projects from under the sewing machine and trim the threads by hand. Pull the upper thread to the wrong side of the fabric and knot it with the bobbin thread.

## 9.17 Sewing Eyelets



For increased stability sew the eyelet twice. Adjust stitch with the balance if necessary.

Prerequisite:

- The Reverse Pattern Foot #1C or the Open Embroidery Foot #20C is fitted.



- > Tap «Buttonholes».
- > Select Eyelet with Small Zigzag No. 61 or Eyelet with Straight Stitch No. 62.
- > Turn the, «Upper Multi-function Knob» or «Lower Multi-function Knob» to alter the size of the eyelet.
- > Sew the Eyelet Program.
  - The machine stops automatically at the end of the Eyelet Program.
- > Use an awl, punch pliers or a hole punch to open the eyelet.




## 10 Quilting

### 10.1 Overview Quilt Stitches



Stitch Patterns	Stitch Number	Name	Description
	No. 1301	Quilting, Securing Program	To secure at the sewing start and sewing end with short stitches forward.
	No. 1302	Quilting, Straight stitch	For machine quilting using a straight stitch with a 3 mm stitch length.
	No. 1303	Piecing stitch/Straight stitch	For sewing patchwork parts together using a straight stitch with a 2 mm stitch length.
	No. 1304 – No. 1308	Hand-look Quilt Stitch	For attaching an imitation of hand-look stitch with monofilament.
	No. 1309 – No. 1314	Blanket Stitch	For appliqués and sewing on ribbons.
	No. 1315	Satin Stitch	For appliqué.
	No. 1316	Narrow Blind Stitch	For hidden sewing of applications.
	No. 1317 – No. 1327 No. 1329 – No. 1330 No. 1339 – No. 1346 No. 1363 – No. 1371 No. 1373 – No. 1389	Decorative Quilt Stitch	For quilting, crazy patchwork, embellishing and finishing.
	No. 1331	Stippling Stitch/ Stippling Quilt Stitch	For imitations of stippling stitch.

Stitch Patterns	Stitch Number	Name	Description
	No. 1332 – No. 1338	Feather Stitch	For quilting, crazy patchwork, embellishing and finishing.

## 10.2 Quilting, Securing Program

Prerequisite:

- The Reverse Pattern Foot #1C is fitted.

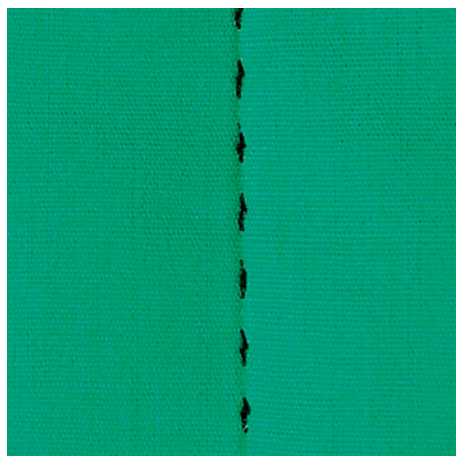


- > Tap «Quilt Stitches».
- > Select Quilting, Securing Program No. 1301.
- > Press the foot control.
  - The machine automatically sews 6 short stitches forward at the sewing start.
- > Sew the seam at the desired length.



- > Push the button «Quick Reverse».
  - The machine automatically sews 6 short stitches forward and automatically stops at the end of the securing program.

## 10.3 Sewing Handlook Quilt Stitches



Hand-look quilt stitches are suitable for all fabrics and sewing projects that should look like stitched by hand. It is recommended to use a monofilament thread as upper thread and an embroidery thread as bobbin thread. The sewing speed should be moderate to prevent the monofilament from breaking. If required, the upper thread tension and the balance can be adjusted to the sewing project and the desired quilt stitch.

Prerequisite:

- The Reverse Pattern Foot #1C is fitted.



- > Tap «Quilt Stitches».
- > Select Hand-look Quilt Stitch No. 1304 No. 1308.
- > If necessary, adjust the upper thread tension and the Balance to suit the sewing project and the desired quilt stitch.
- > To start the machine, press the foot control or push the button «Start/Stop».



## 10.4 Guiding the Quilt Work Freely



Freehand quilting and darning use the same principle of free movement. With stipple quilting, entire surfaces of the fabric are filled with quilt stitches. The single lines of stitching are rounded and never cross one another.



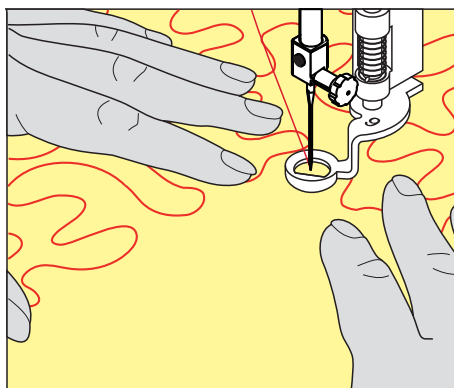
- Quilting gloves with rubber nubs make it easier to guide the fabric.
- For the best possible results use the High Thread Tension Bobbin Case (optional accessory).
- It is recommended to use the slide-on table and the Free Hand System.
- With free motion quilting, it is of advantage to quilt from the center outwards and to guide the fabric using smooth, round movements to form the design of your choice.

Prerequisite:

- The top layer, the batting and the backing are pinned together or basted.
- The feed dog is lowered.
- The Darning Foot #9 is fitted.



- > Tap «Practical Stitches».
- > Select Straight Stitch No. 1.
- > If required, adjust the upper thread tension.
- > To prevent the fabric from shifting, select the needle position down.
- > To start the machine, press the foot control or push the button «Start/Stop».
- > Hold both hands close to the presser foot like an embroidery hoop to guide the fabric. Make sure that the needle does not pierce the same place several times in a row.
- > To ensure a minimum stitch distance when quilting corners, reduce the embroidery speed.
- > If the thread is lying on top of the fabric, slow down the movement.
- > If there are knots on the wrong side of the fabric, move the fabric more quickly.



## 11 BERNINA Stitch Regulator (BSR)

The BERNINA Stitch regulator equalizes the stitch length which results of the free movement of the fabric while free-motion sewing - a sewing technique which grows more and more popular. When free-motion sewing with the BSR presser foot, every stitch is equally long and the stitch formation is perfectly regular.

As soon as the BSR presser foot is attached and the feed dog is lowered, the selection menu of the desired mode appears in the display of the machine. The BSR presser foot can be used with sewing straight stitch as well as zig zag.

The BSR presser foot reacts on the movement of the fabric and therefore controls the speed of the machine up to the highest possible speed. It can be said: The faster the movement of the material, the higher the speed of the machine.

If the fabric is moved too quickly, an acoustic signal sounds. The beeper can be activated or deactivated in the «BSR» display. The sound of the beeper can also be activated or deactivated in the Setup Program.

### 11.1 BSR Mode 1

The BSR function can be controlled via the foot control or the button «Start/Stop». Start the BSR mode. At the BSR presser foot a red light is on. By moving the fabric the machine accelerates. If the fabric isn't moved, securing in place is possible without pressing an additional button. When working via the foot control or when using the button «Start/Stop», the BSR mode doesn't stop automatically.

### 11.2 BSR Mode 2

The BSR function can be controlled via the foot control or the button «Start/Stop». The machine starts only when the foot control or the button «Start/Stop» is pressed and the fabric is moved simultaneously. Without moving the fabric, the BSR2 mode stops after 7 seconds. The red light goes off (only when working with the button «Start/Stop»). When working via the foot control, the red light doesn't go off.

### 11.3 BSR mode 3

BSR mode 3 is stitching mode. In basting mode, you can choose between two stitch lengths:

- SPI 2: Two stitches per inch
- SPI 4: Four stitches per inch

### 11.4 BSR Function with Straight Stitch No. 1

This function allows free-motion quilting with straight stitch and a pre-programmed stitch length up to 4 mm. The programmed stitch length is maintained within a certain speed, independent of the fabric movement.

### 11.5 BSR Function with Zigzag No. 2

The zig zag can be used e.g. for thread painting. The set stitch length will **not** be maintained when sewing the zig zag stitch, but the BSR function simplifies the application. Anwendung.

### 11.6 Sewing Preparations for Quilting

#### Attach the BSR Presser Foot

Prerequisite:

- The machine is switched off.

#### NOTICE

The Lens of the BSR Presser Foot is Dirty

The machine doesn't recognize the BSR presser foot.

> Clean the lens with a soft, slightly damp cloth.

> Change the presser foot.

- > Insert the cable of the BSR Foot into the connection (1).



- > Switch the machine on.
  - The BSR display opens and the BSR1 Mode is activated.

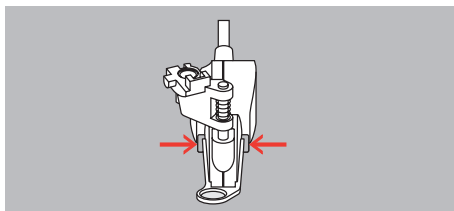
## Changing the Presser Foot

### NOTICE

The Lens of the BSR Presser Foot is Dirty

The machine doesn't recognize the BSR presser foot.

- > Clean the lens with a soft, slightly damp cloth.
- 
- > Raise the needle.
  - > Raise the BSR foot.
  - > Switch off the machine.
  - > Remove the BSR foot from the machine.
  - > Press both push buttons at the BSR foot against each other.



- > Pull the presser foot sole out of the guide downwards.
- > Insert the new presser foot sole into the guide and push upwards until it clicks into place.
- > Attach the BSR presser foot.

## 11.7 Using the BSR Mode

The BSR function can either be operated via the foot control or via the button «Start/Stop».

Start via the Foot Control: The foot control must be pressed down while quilting is in progress. The machine keeps running in BSR Mode 1 until the foot control is released, even if the fabric is not moved.

If quilting in BSR Mode 2 is stopped, the machine sews another stitch depending on the needle position and stops with needle position up.

Prerequisite:

- The slide-on table has been fitted.
- The knee lifter is attached.



> Lower the feed dog.

> Select the desired BSR Mode.



> To lower the presser foot, push the button «Start/Stop» or press the foot control.

- > To start the BSR Mode, push the button «Start/Stop» again or press and hold the foot control again.
  - A red light is lit on the BSR Presser Foot.




- > Move the fabric to control the speed of the machine in the BSR Mode.
-  > To stop the BSR Mode, push the button «Start/Stop» again or release the foot control.
  - The BSR Mode stops and the red light at the presser foot goes off.
-  > To deactivate the BSR Mode and to quilt without automatic stitch lengths, tap «BSR Mode».



## 11.8 Securing Stitches


### Securing in BSR1 Mode with the Button «Start/Stop»

Prerequisite:

- The BSR presser foot is fitted and connected to the machine.
- The BSR display opens and a BSR1 Mode is active.
- > Lower the feed dog.
- > Lower the presser foot.
-  > Push the button «Needle position Up/Down» 2x.
  - The bobbin thread is brought up.
- > Hold the upper and the bobbin thread.
-  > Push the button «Start/Stop».
  - Start the BSR Mode.
- > Sew 5 – 6 securing stitches.
-  > Push the button «Start/Stop».
  - The BSR Mode stops.
- > Cut the thread.

### Securing in BSR2 Mode

Prerequisite:

- The BSR presser foot is fitted and connected to the machine.
- The BSR display opens and a BSR2 Mode is active.
- > Lower the presser foot.
-  > Push the button «Securing Stitches».
- > Press the foot control or push the button «Start/Stop».

By moving the fabric some short securing stitches are sewn, then the programmed stitch length is activated and the securing function is deactivated automatically.

## 11.9 Using the KickStart Function

The KickStart function enables quilting without keeping the foot control pressed.

Prerequisite:

- The BSR Presser Foot is fitted and connected to the machine.
- The BSR display opens and a BSR Mode is active.





- > Tap «KickStart».
  - The KickStart display appears. The selected BSR Mode is displayed.
- > To start the machine, press the foot control **briefly** with your heel.
  - The machine starts sewing with the selected settings as soon as the fabric is moved.
- > To stop the machine, press the foot control briefly with your heel again.
  - The machine will stop, but the KickStart function will remain active.
- > To end the KickStart function, tap the screen or press the foot control at the front.
  - The BSR display appears.
  - The KickStart function will be deactivated.
  - The function programmed for the Back-kick will be active.

#### Please note

- While the KickStart function is active, the function programmed for Back-kick is deactivated. The Back-kick then only serves to start and stop the machine.
- The KickStart function will be ended immediately if the active monitoring function reports an error (e.g. thread breakage or bobbin empty).
- The KickStart function will be ended immediately if the foot control cable is unplugged.
- If there is no sewing in BSR Modes, the machine goes into Stand-by Mode after 7 seconds. Exit the Stand-by Mode by pressing the heel again.
- If no sewing is done for up to 60 seconds, the KickStart function is automatically terminated. The KickStart display disappears.

## 12 My BERNINA Embroidery

### 12.1 Overview Embroidery Module



- |   |                                |   |                             |
|---|--------------------------------|---|-----------------------------|
| 1 | Embroidery arm                 | 3 | Guide rails for the machine |
| 2 | Coupling for securing the hoop | 4 | Connection to the machine   |

### 12.2 Supplied Accessories Embroidery Module

#### Overview Accessory Embroidery Module








Illustration	Name	Purpose
	Embroidery Foot #26L	For embroidering, darning and freehand quilting.
	Large Oval Embroidery Hoop	To embroider large embroidery designs or design combinations up to 145 x 255 mm (5.70 x 10.04 in).  Template for precise fabric positioning included.

Illustration	Name	Purpose
	Medium Embroidery Hoop	To embroider medium-sized embroidery designs up to 100 x 130 mm (3.94 x 5.12 in).  Template for precise fabric positioning included.
	Small Embroidery Hoop	To embroider small embroidery motifs up to 72 x 50 mm (2.83 x 1.97 in).  For free arm embroidering with closed sewing projects such as sleeves, trouser legs or socks.  Template for precise fabric positioning included.
	Embroidery Needle Assortment	For embroidering.
	Template Holder	To place and remove the template in or out of the embroidery hoop.
	Spool Net	For even thread unwinding with smooth threads from the thread spool, e.g. nylon, rayon, silk threads or metallic yarns.

## 12.3 Overview User Interface

### Overview Functions/Visual Information



- |   |                                   |
|---|-----------------------------------|
| 1 «WiFi»  | 5 «Stitch Plate/Needle Selection» |
| 2 «Upper Thread Tension»                          | 6 «Feed Dog Indicator»            |
| 3 «Presser Foot Indicator/Presser Foot Selection» | 7 «Bobbin Thread»                 |
| 4 «Presser Foot Pressure»                         | 8 «Laser»                         |

## Overview System Settings



- |   |                         |   |                  |
|---|-------------------------|---|------------------|
| 1 | «Home»                  | 5 | «Help»           |
| 2 | «Setup Program»         | 6 | «eco Mode»       |
| 3 | «Tutorial»              | 7 | «Clear Settings» |
| 4 | «Embroidery Consultant» |   |                  |

## Overview Selection Menu Embroidery



- |   |             |   |                     |
|---|-------------|---|---------------------|
| 1 | «Selection» | 3 | «Color Information» |
| 2 | «Edit»      | 4 | «Embroidery»        |

## 12.4 Important Embroidery Information

### Upper Thread

A good quality thread (name-brand manufacturer) is essential for embroidery so that the embroidery is not affected negatively because of poor thread or thread breakage.

Embroidery is particularly effective if you use 40wt glossy rayon or polyester embroidery threads as upper threads. They are available in a wide range of colors for beautiful embroidery.

- Polyester with a brilliant sheen is a hard-wearing, colorfast thread and has a high tensile strength which is suitable for all types of embroidery.
- Rayon is a soft viscose fiber with a brilliant sheen and suitable for fine, delicate embroidery, or items that will not receive excessive wear and tear.
- Metallic thread is a light to medium-weight thread suitable for special effects in embroidery.
- When working with metallic threads, the automatic bobbin thread cutter should be deactivated. The other thread cutters shouldn't be used either because the knives are likely to wear off very quickly.

- When using metallic threads, the speed and the upper thread tension should be reduced.



### Bobbin Thread

In most cases black or white bobbin thread is used for embroidering. When both sides should have the same look, it is recommended to use the same color for bobbin and upper thread.

- Bobbin Fill is an especially soft and light polyester thread which is suited to be used as bobbin thread. This special bobbin thread ensures a steady thread tension and an optimal intertwining of the upper and bobbin thread.
- Darning and embroidery threads are fine mercerized cotton threads which are suitable for embroidery on cotton.



### Selecting the Embroidery File Format

In order that embroidery designs can be read by the BERNINA embroidery machine, they have to be created by the BERNINA Embroidery Software and exported as EXP file. In addition to the actual embroidery file, a BMP file and an INF file are also generated. The BMP file allows a preview of the embroidery design and the INF file provides the information on the thread colors. **Note:** If the INF file is missing, the embroidery design cannot be displayed in the real color but only in standard colors. In this case, the colors can be entered manually in the color overview of the motif on the machine.

Additionally, following embroidery formats can be read by the machine: PES, PEC, XXX, PCS, JEF and DST. BERNINA International AG doesn't warrant that embroidery designs which have not been created or converted by the BERNINA Embroidery Software can be correctly read and embroidered.

### Embroidery Test

For the embroidery test, always use the original material reinforced with the same stabilizer as will be used later. For the embroidery test it is recommended to use the same colors, threads and needles which are planned to be used for the embroidery project.

### The Size of the Embroidery Design

Embroidery designs can be enlarged or downsized on the embroidery machine or on the PC using the BERNINA Embroidery software (optional accessory). Scaling up/downsizing in a range of +/- 20 % provides the best results.

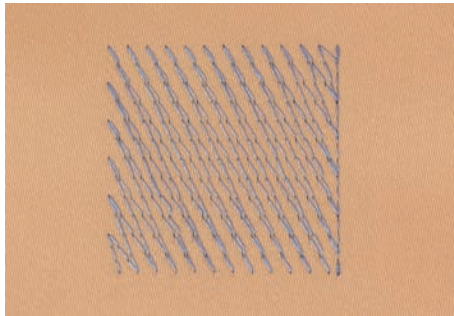
Quilt patterns of file format BQM are vector-based embroidery designs that can be customized to almost any size. The stitch length remains consistent when adjusting the design size, as set in the embroidery settings in the Setup Program.

### Embroidering Designs by Third-party Providers

BERNINA recommends loading an embroidery design in any file format onto a USB stick via the free «ART-Link» program. Using «ART-Link» ensures that the embroidery design can be read and embroidered correctly. «ART-Link» can be downloaded for free at [www.bernina.com/artlink](http://www.bernina.com/artlink).

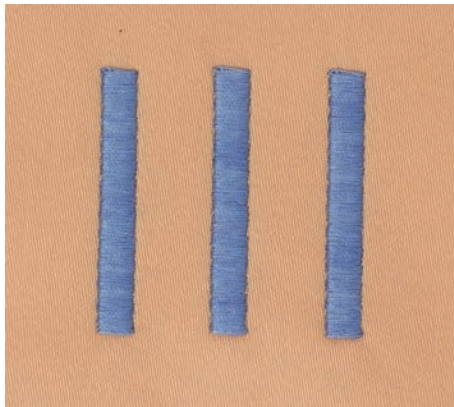
### Underlay Stitches

Underlay stitches are the foundation of a motif and are used to stabilize the base material and hold it in shape. They also prevent the covering stitches of the motif from sinking into the knit or the nap of the material.



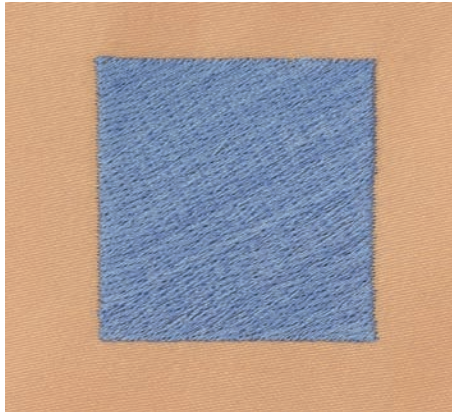
### Satin or Leaf Stich

The needle moves left to right and vice versa. The result is a very dense, covering zig zag stitching to fill the shape. Satin stitching fills are ideal for narrow and small shapes. Satin stitching is, however, not suitable for larger areas, since wide stitches are too loose and do not cover the fabric properly. In addition there is the risk that with too long stitches the threads could catch on something which would damage the embroidery.



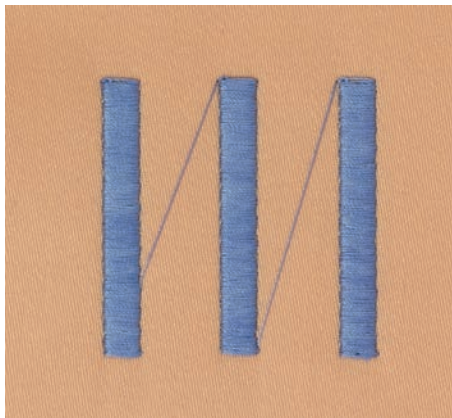
### Step Stitch

Many short, equally long stitches are embroidered in offset rows closely next to each other which results in a densely filled area.



### Connecting Stitches

Long stitches which are used to get from one part of the motif to the next. Before and after the connecting stitch securing stitches are sewn. Connecting stitches are trimmed.



## 13 Embroidery Preparation

### 13.1 Attaching the Module

#### NOTICE

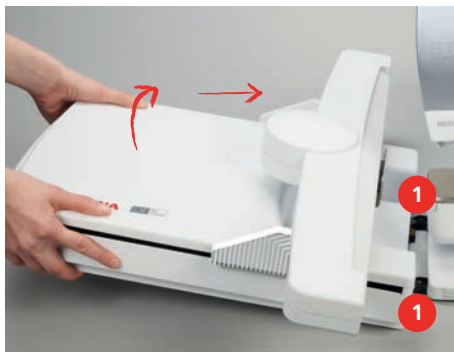
#### Transporting the Embroidery Module

Damage to the embroidery module connection and machine.

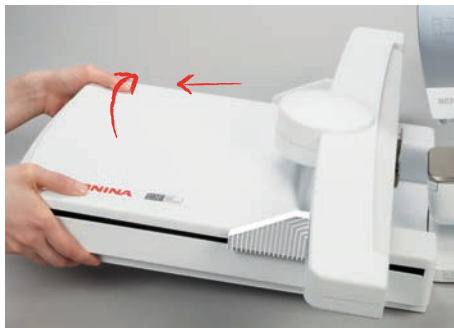
- > Remove the embroidery module before transporting the machine.

Prerequisite:

- Extension table must not be fitted.
- > Make sure that the module and the machine are placed on a stable, even surface.
- > Ensure that the embroidery arm can move freely.
- > Lift the embroidery module on the left side.
- > Carefully push the module from left to right into the embroidery module connection (1) of the machine.



- > To remove, lift the embroidery module on the left and carefully pull to the left.



### 13.2 Preparing the Machine

#### Lowering the Feed Dog

- > Push the button «Feed Dog Up/Down».





## Selecting the Embroidery Design

All of the embroidery designs can be either directly embroidered or can be changed using different functions offered by the embroidering machine. You can find all embroidery designs at the end of the instruction manual. All the stitch patterns contained in the sewing mode can also be embroidered. The stitch patterns are displayed in files, sorted in Categories, like in the sewing mode. In addition to that, embroidery designs can be downloaded from the Personal Memory or from the USB stick (optional accessory).

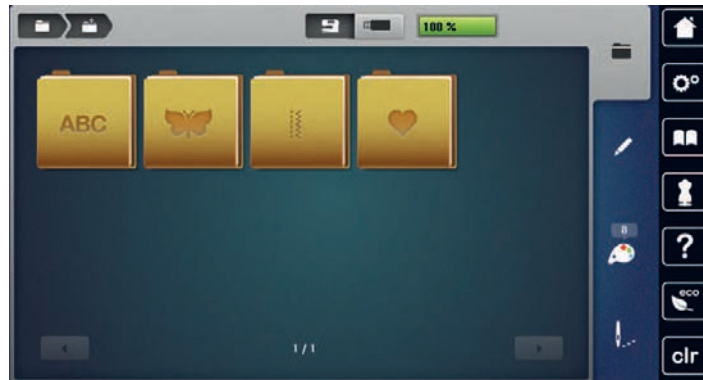


> Tap «Home».



> Tap «Embroidery Mode».

> Select an alphabet, embroidery design, stitch pattern or a personal embroidery design from a file.



## 13.3 Embroidery Foot

### Attaching the Embroidery Foot

- > Raise the needle.
- > Raise the presser foot.
- > Switch off the machine.
- > Push the clamping lever up.
- > Remove the presser foot.
- > Insert the embroidery foot from below into the bracket.
- > Press the clamping lever down.



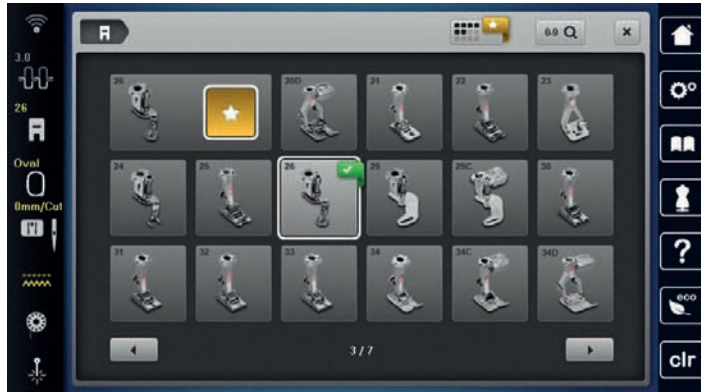
### Selecting the Stitch Plate in the User Interface

After fitting the corresponding embroidery foot, it can be selected and saved on the machine. Furthermore, any alternative feet that are available for the respectively selected embroidery design are displayed.

- > Switch the machine on.
- > Select the embroidery design.



> Tap «Presser Foot Indicator/Presser Foot Selection».



> To display all suitable presser feet for the selected embroidery design, tap «Optional Presser Feet».  
 > Select the fitted embroidery foot.

## 13.4 Needle and Stitch Plate

### Inserting the Embroidery Needle



Embroidery needles of the type 130/705 H-SUK provide a larger eye and are slightly rounded. This avoids thread abrasion when using Rayon- and cotton embroidery thread. Depending on the embroidery thread use a size No. 70-SUK to No. 90-SUK needle.

- > Raise the needle.
- > Switch off the machine.
- > Remove the fitted foot.
- > Loosen the fixing screw of the needle using the screwdriver gray Torx.



- > Pull the needle down.
- > Hold the new needle with the flat side to the back.
- > Insert the needle as far as it will go.
- > Tighten the needle clamp using the gray Torx screwdriver.

### Selecting the Embroidery Needle in the User Interface

After changing the needle, you can check whether this can be used with the selected stitch plate.



> Tap «Needle Selection».

- > Select the fitted needle.



- If the selected needle is suitable in combination with the stitch plate, embroidering can be started.
- If the selected needle is not suitable in combination with the stitch plate, starting the machine is automatically blocked.

## Remembering Needle Type and Needle Size

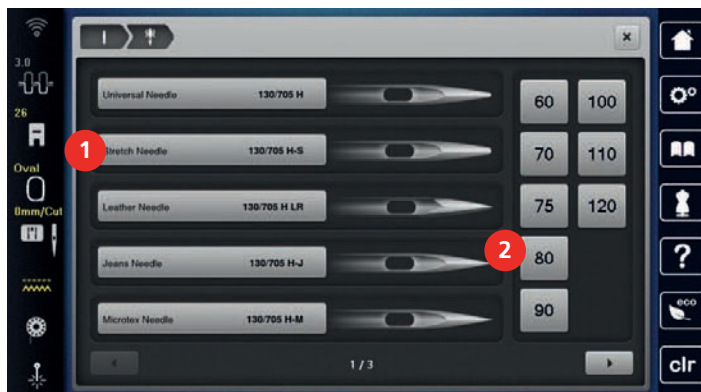
Convenient memory function: To prevent a loss of information, the needle type and the needle size can be saved additionally on the machine. The saved needle type and the saved needle size can be checked at any time.



- > Tap «Needle Selection».



- > Tap «Needle Information».



- > Select the needle type (1) of the fitted needle.
- > Select the needle type (2) of the fitted needle.

## Attaching the Stitch Plate

The stitch plate (Straight and CutWork Stitch Plate) has a small hole in the needle area. The stitch formation is subsequently optimized (knotting of upper and bobbin threads). This results in a more beautiful stitch appearance.

- > To lower the feed dog, push the button «Feed Dog Up/Down».
- > Switch off the machine.
- > Remove the needle.
- > Remove the presser foot.

- > Press the stitch plate down at the marking at the back on the right until it tilts.



- > Remove the stitch plate.
- > Place the opening of the stitch plate (Straight and CutWork Stitch Plate) above the corresponding guide pins and press it down until it clicks into place.

### Selecting the Stitch Plate in the User Interface

After changing the stitch plate, you can check whether it can be used with the selected needle.



- > Tap «Stitch Plate Selection».
- > Select Straight and CutWork Stitch Plate.



### Thread-up Command

The machine must be ready for embroidery to bring up the bobbin thread. The bobbin thread can be brought up in one step for a manual knotting. If no securing stitches are wanted, it is recommended to deactivate the securing stitches in the Setup.



- > Hold the upper thread.
- > Push the button «Needle position Up/Down».
  - The bobbin thread is brought up automatically.

### Switching the Laser On/Off

The laser can be used to indicate the exact needle entry point.

Prerequisite:

- The needle is raised.



- > To activate the laser, tap «Laser».
  - The entry point is displayed. Depending on the presser foot and needle position, the entry point may be concealed by the presser foot.
- > To avoid the deflection of the laser with transparent presser feet, lower the presser foot before the sewing start, e.g. with the knee lifter.
- > To switch off the laser, tap the field highlighted in yellow «Laser».

## 13.5 Embroidery Hoops

### Overview Embroidery Hoop Selection



1 Hoop Selection

### Selecting the Embroidery Hoop

The best embroidery result is achieved when the smallest possible embroidery hoop for the embroidery design is selected.

The embroidery design has a pre-set size which is displayed.

Prerequisite:

- The embroidery design is selected.



- > Tap «Hoop Indicator/Select Hoop».
  - The machine selects the optimal embroidery hoop according to the size of the embroidery design automatically. If the preset embroidery hoop is not available, another desired embroidery hoop can be selected. When an embroidery hoop is attached which does not correspond with the selected one, the attached hoop is considered active and the embroidery design area is displayed accordingly.
- > Select the desired embroidery hoop.

### Tear-away Stabilizers

Using a stabilizer ensure more stability of the embroidery project. A tear-away stabilizer suits all woven and non-stretch materials. 1 – 2 layers can be used. Stabilizers are available in different weights. With larger areas to be embroidered the stabilizer will remain under the embroidery thread. The stabilizer is applied to the wrong side of the fabric with temporary adhesive spray. Carefully cut away excess stabilizer after embroidering.

### Cut-away Stabilizers

Using a stabilizer ensure more stability of the embroidery project. A cut-away stabilizer suits all elastic materials. 1 – 2 layers can be used. Stabilizers are available in different weights. With larger areas to be embroidered the stabilizer will remain under the embroidery thread. The stabilizer is applied to the wrong side of the fabric with temporary adhesive spray. Carefully cut away excess stabilizer after embroidering.

### Using Adhesive Spray

The application of spray adhesive is recommended for stretch and smooth materials and knitware. It prevents the fabric from losing shape and slipping. Appliqués can be exactly positioned with spray adhesive. The spray adhesive shouldn't be used near the machine to avoid contamination.

- > Use the spray adhesive carefully at a distance 25 – 30 cm (9 – 12 inch) when spraying the stabilizer.
- > Adhere the sprayed stabilizer to the wrong side of the fabric carefully, smoothing material so there are no puckers.
- > Position smaller parts such as pocket flaps or collars on the stabilizer.

- > To avoid the possibility of getting hoop marks when working with napped materials or fleece, don't hoop the parts but spray the stabilizer and hoop it.
- > Adhere the fabric to be embroidered.
- > Remove any adhesive residue before starting the machine.

### Using Spray Starch

Spray starch is ideal for additional stiffening fine, loosely woven materials. Always use an additional stabilizer on the wrong side of the material.

- > Spray the area to be embroidered.
- > Let it dry or press gently with a warm iron if necessary.

### Using Iron-on Interfacing

Iron-on interfacings are available in a variety of weights. It is recommended to use an iron-on interfacing which is easily removable from the basic fabric. An iron-on interfacing suits all materials that are easily distorted like stretch fabric such as tricot and jersey.

- > Iron-on interfacings are ironed to the wrong side of the material using a warm iron.

### Using Paper-backed Adhesive Stabilizer

Paper-backed adhesive stabilizers are intended to be used for fabrics such as jersey and silk as well as for embroidery projects which are not suited to be hooped in the embroidery hoop.

- > Place the stabilizer in the hoop, so that the paper side is up.
- > Use a pair of scissors to score the paper and remove paper in the hoop area.
- > Position the fabric to be embroidered on the stabilizer and press it on place.
- > Remove any adhesive residue before starting the machine.

### Using Water-soluble Stabilizer



For lace embroidery it is recommended to hoop 1 - 3 layers of water-soluble stabilizer in the embroidery hoop. As the embroidery design is not embroidered on the fabric, only the thread embroidered design is left. The embroidery designs should be combined with short stitches otherwise the individual designs may fall out.

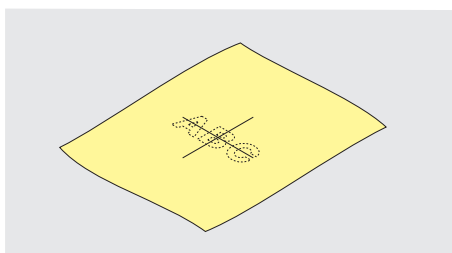
Water-soluble stabilizers are ideal for fine, sheer fabrics where other stabilizers may show through the embroidery stitches as well as for lace embroidery. The stabilizer dissolves in water. Water-soluble stabilizers are an ideal protection for looped pile fabrics preventing the loops from being damaged. It prevents threads from sinking into the material and keeps the fabric pile from poking through the embroidery.

- > Place the stabilizer on the underside of the material.
- > Use adhesive spray to adhere stabilizer if necessary.
- > For material with a pile, reinforce with additional, suitable stabilizer on the wrong side.
- > Place all the layers together into the embroidery hoop.
- > After dissolving, lay the motif down flat and let dry.

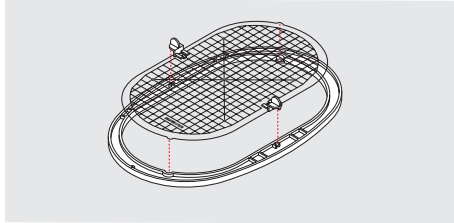
### Preparing the Embroidery Hoop

The embroidery hoop consists of an outer and an inner hoop. There is a corresponding template for every hoop. The area to be embroidered is marked in 1 cm (0.39 inch) squares. The center and corner points are marked with holes. The required marks can be transferred to the material.

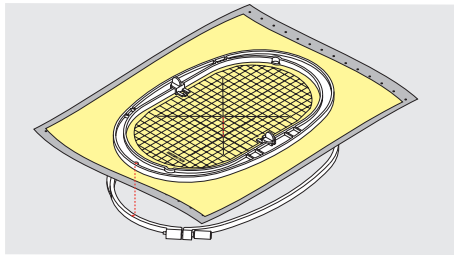
- > Mark the center of an embroidery design on the fabric, using a water-soluble pen.



- > Loosen the screw on the outer hoop.
- > Remove the inner hoop.
- > Make sure that the arrows marks of both hoops match.
- > Attach the template holder.
- > Place the template in the inner hoop, so the BERNINA logo is at the front edge at the arrow mark until it clicks into place.



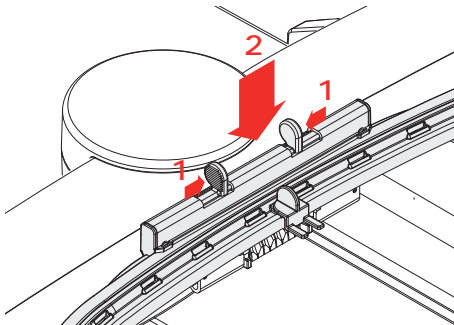
- > Place the fabric under the inner hoop.
- > Line up the marked center point on the center of the template.
- > Place the material and the inner hoop on the outer hoop, so that the arrow markings of both hoops are aligned.



- > Fit the hoops into each other so that the material does not move.
- > Hoop the fabric tautly in the embroidery hoop.
- > Tighten the screw.
- > Remove the template from the hoop by using the template holder.
- > To avoid scratches on the free arm, press the inner hoop into the outer hoop so that the inner hoop including the fabric protrudes downwards by up to 1 mm.

### Attaching the Hoop

- > Raise the needle.
- > Raise the embroidery foot.
- > Hold the hoop with the right side of the fabric up with the attaching mechanism to the left.
- > Position the hoop below the embroidery foot.
- > Press both attaching mechanisms (1) of the hoop towards each other.
- > Position the embroidery hoop (2) above the bracket of the embroidery arm.
- > Press the hoop down until it clicks in position.
- > Release the attaching mechanism (1).



- > Press the attaching mechanisms of the hoop towards each other to remove the hoop.
- > Remove the hoop.

## Centering the Needle to the Embroidery Hoop

Relocating the embroidery hoop facilitates threading when the needle is close to the embroidery hoop.



- > Tap «Hoop Indicator/Select Hoop».



- > Tap «Center the Needle to the Embroidery Hoop».
- > Thread the upper thread.



- > To move the hoop back to its previous position, push the button «Start/Stop».

## Move Hoop to the Back

To facilitate changing the bobbin, it is recommended to move the hoop to the back before threading. This makes it easier to open the bobbin cover.



- > Tap «Hoop Indicator/Select Hoop».



- > Tap «Move Hoop to the Back».
- > Thread the bobbin thread. (see page 48)



- > To move the hoop back to its previous position, push the button «Start/Stop». If necessary, pull back the upper thread.

## Moving the Module for the Sewing Mode

The embroidery module can be positioned so that any sewing projects can be carried out even if the module is connected.



- > Tap «Hoop Indicator/Select Hoop».
- > Remove the hoop.



- > Tap «Move Hoop to the Left».



- > Tap «Home».



- > Tap «Sewing Mode».

## Grid On/Off

When the center of the hoop and the grid are displayed, the embroidery design can be positioned more exactly.



- > Tap «Hoop Indicator/Select Hoop».



- > To show the hoop center on the display, tap «Grid On/Off».
- > To show the grid lines, tap «Grid On/Off» again.
- > To hide the hoop center and the grid lines, tap «Grid On/Off» again.

## Locating the Center of the Embroidery Design

The embroidery hoop is positioned so that the needle is exactly above the center of the embroidery design or the motif begin.



- > Tap «Hoop Indicator/Select Hoop».



- > To position the hoop so that the needle is placed exactly over the center of the embroidery design, tap «Center of Embroidery Design».
- > To position the hoop so that the needle is placed exactly over the motif start, tap «Center of Embroidery Design» again.



## Virtual Positioning of the Embroidery Hoop

The embroidery hoop is automatically moved to the new position as soon as the embroidery design is repositioned. Therefore, the icon «Virtual Positioning» is activated automatically and outlined in yellow when an embroidery hoop is attached.

Prerequisite:

- The hoop is attached.



- > Tap «Hoop Indicator/Select Hoop».



- > To deactivate the automatic movement of the hoop after repositioning the embroidery design, tap «Virtual Positioning».
  - The «Virtual Positioning» is not yellow-outlined.
- > To activate the automatic movement of the hoop after repositioning the embroidery design, tap «Virtual Positioning» again.

## 14 Setup Program

### 14.1 Adjusting the Embroidery Settings in the Setup Program

Further information about this topic (see page 54).

## 15 Creative Embroidering

### 15.1 Overview Embroidering



- |   |  |   |                          |
|---|--|---|--------------------------|
| 1 | Embroidery Time/Embroidery Design Size                       | 4 | «i-Dialog»               |
| 2 | Scaling Up, Downsizing and Moving the Embroidery Design View | 5 | Embroidery design Layers |
| 3 | Area to be Embroidered                                       |   |                          |

### 15.2 Selecting and Changing the Embroidery Design



- > Tap «Selection».



- > Tap «Loading the Embroidery Design».
- > Select a new embroidery design.

### 15.3 Checking the Embroidery Time and the Embroidery Design Size

In the selection menu «Edit» the estimated embroidery time in minutes as well as the width and height of the embroidery design is indicated at lower left (1).

### 15.4 Regulating the Speed

The sewing speed can be adjusted infinitely variable with the slide.

- > Move the slide to the left to reduce the sewing speed.
- > Move the slide to the right to increase the sewing speed.

## 15.5 Editing the Embroidery Design




### Overview Editing embroidery motif



- |    |                                |    |  |
|----|--------------------------------|----|--|
| 1  | «Move View»                    | 11 | «Duplicate»  |
| 2  | «Move the Embroidery Design»   | 12 | «Endless Embroidery»   |
| 3  | «Zoom Out»                     | 13 | «Delete an Embroidery Design»  |
| 4  | «Zoom In»                      | 14 | «Shape Designer»   |
| 5  | «Move the Embroidery Design»   | 15 | «Check Embroidery Design Size»   |
| 6  | «Rotate the Embroidery Design» | 16 | «Word Art»<br>(active when a lettering is selected)                      |
| 7  | «Change Design Size»           | 17 | «Group Embroidery Designs»   |
| 8  | «Pinpoint Placement»           | 18 | «Change Embroidery Design Sequence»                                      |
| 9  | «Mirror Image Left/Right»      | 19 | «Alter Stitch Type/Stitch Density»                                       |
| 10 | «Mirror Image Up/Down»         | 20 | «Align the Embroidery Design»<br>(active when a combination is selected) |


### Scaling Up the Embroidery Design View

The view of the embroidery design can be scaled up. In addition to that, the view can be adjusted with or without changing the embroidery position.

- > Select the embroidery design.
-  > To edit the view of the embroidery design, tap «Zoom In».
-  > To scale up the view of the embroidery design, tap «Zoom In» 1 up to 4 times.
-  > To get back to the Edit Mode, tap «Zoom Out» 1 up to 4 times.



### Downsizing the Embroidery Design

The view of the embroidery design can be downsized. In addition to that, the view can be adjusted with or without changing the embroidery position.

- > Select the embroidery design.
-  > To edit the view of the embroidery design, tap «Zoom In».
-  > To downsize the view of the enlarged embroidery design gradually, tap «Zoom Out» 1 – 4 times.




## Moving the Embroidery Design View

The view of the embroidery design can be moved. In addition to that, the view can be adjusted with or without changing the embroidery position.



- > Select the embroidery design.
-  > To activate «Move View», tap «Zoom In».
  - «Move View» is activated (dark gray).
- > Move the view of the embroidery design.
  - The embroidery position is not altered.
-  > To get back to the Edit Mode, tap «Zoom Out».

## Moving the Embroidery Design in Enlarged View

In addition to that, the view can be adjusted with or without changing the embroidery position. In addition to that, the view can be adjusted with or without changing the embroidery position.

- > Select the embroidery design.
-  > To display the icon «Relocating a Stitch Pattern», tap «Zoom In».
-  > Tap «Move the Embroidery Design».
  - The icon turns dark gray.
- > Move the view of the embroidery design.
  - The embroidery position is altered.
-  > To get back to the Edit Mode, tap «Zoom Out».

## Moving the Embroidery Design

- > Select an embroidery motif.
-  > Tap «i-Dialog».
-  > Tap «Move the Embroidery Design».
  - > Turn the «Upper Multi-function knob» to move the embroidery motif horizontally in 1/10-mm steps.
  - > Turn the «Lower Multi-function knob» to move the embroidery motif vertically in 1/10 mm steps or tap and hold the embroidery motif to move the embroidery motif as you like.
    - The relocation is indicated in the yellow-outlined icons.



-  > Tap «Center Design in Hoop».
  - The embroidery motif is repositioned in the center of the embroidery hoop.

## Rotating the Embroidery Design



- > Select the embroidery design.
- > Tap «i-Dialog».



- > Tap «Rotate the Embroidery Design».
- > Turn the «Upper Multi-function Knob» or the «Lower Multi-function Knob» to the right to rotate the embroidery design clockwise.
- > Turn the «Upper Multi-function Knob» or the «Lower Multi-function Knob» to the left to rotate the embroidery design counter-clockwise.



- > To rotate the embroidery design in 90°-steps, tap «Rotate the Embroidery Design +90°».

## Altering the Embroidery Design Size Proportionally



Enlargements or reductions of the motif size up to maximum 20 % achieve the best results.

If the motif size is to be altered by more than 20 %, the motif should be adapted in a separate embroidery software and then reloaded onto the machine.



- > Select the embroidery design.
- > Tap «i-Dialog».



- > Tap «Change Design Size».



- > If «Retain Proportions» is not outlined in white, tap «Retain Proportions».
  - «Retain Proportions» is outlined in white.



- > Turn the «Upper/Lower Multi-function Knob» to the right to scale up the embroidery design proportionally.
- > Turn the «Upper/Lower Multi-function Knob» to the left to downsize the embroidery design proportionally.

## Altering the Embroidery Design Size Disproportionally



Enlargements or reductions of the motif size up to maximum 20 % achieve the best results.

If the motif size is to be altered by more than 20 %, the motif should be adapted in a separate embroidery software and then reloaded onto the machine.



- > Select the embroidery design.
- > Tap «i-Dialog».



- > Tap «Change Design Size».



- > If «Retain Proportions» is outlined in white, tap «Retain Proportions».
- «Retain Proportions» is not outlined in white.



- > To make the embroidery design wider, turn the «Upper Multi-function Knob» clockwise.
- > To make the embroidery design narrower, turn the «Upper Multi-function Knob» anti-clockwise.
- > To make the embroidery design longer, turn the «Lower Multi-function Knob» clockwise.
- > To make the embroidery design shorter, turn the «Lower Multi-function Knob» anti-clockwise.

### Mirroring Embroidery Designs

Embroidery designs can be mirror-imaged both vertically and horizontally.



- > Select the embroidery design.
- > Tap «i-Dialog».



- > To mirror the embroidery design horizontally, tap «Mirror Image Left/Right».



- > To mirror the embroidery design vertically, tap «Mirror Image Up/Down».

### Changing the Stitch Type

If the satin stitches are too long, they can be changed to step stitches.



- > Select the Embroidery Design.
- > Tap «i-Dialog».



- > Tap «Alter Stitch Type/Stroke Density».



- > Touch the switch in the upper section of the display (1) to change the satin stitch to the step stitch.
- > Set and confirm the stitch length 2.

## Altering the Stitch Density

If the satin stitches are embroidered too densely, the stitch density can be adjusted.

- > Select the embroidery design.
- > Tap «i-Dialog».



- > Tap «Alter Stitch Type/Stitch Density».



- > Adjust the stitch density (1).

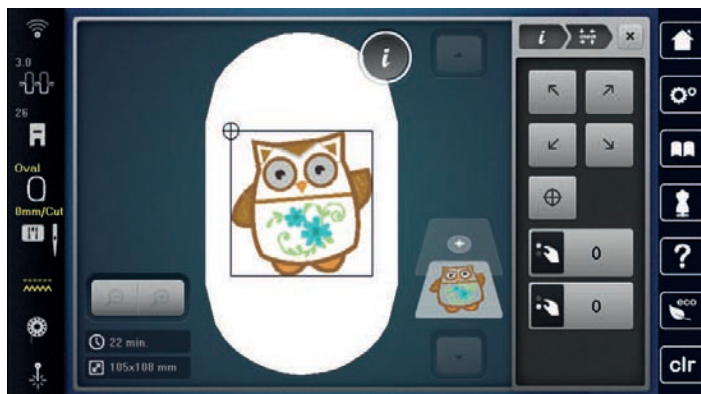
## Checking the Size and the Position of the Embroidery Design

It can be checked whether or not the embroidery design matches the designated position/location on the fabric. Points which are beyond the embroidery hoop are not traveled to.

- > Select the embroidery design.
- > Tap «i-Dialog».



- > Tap «Check Embroidery Design Size».
  - The embroidery hoop travels all the way until the needle is at the position as it is indicated in the display.



- > To select the desired corner of the embroidery design, tap the respective arrow.
  - The embroidery hoop travels all the way until the needle is at the position as it is indicated in the display. If the embroidery design hasn't been positioned correctly yet, the position can be altered via the «Upper/Lower Multi-function knobs» and the complete embroidery positions can be checked again.



- > To position the needle in the center of the embroidery design, tap «Center of Embroidery Design».
- > Turn the «Upper Multi-function Knob» to move the embroidery design horizontally.
- > Turn the «Lower Multi-function Knob» to move the embroidery design vertically.



## Endless Embroidery

When embroidering a border or a trim, it is of advantage to use the Mega Embroidery Hoop or the Maxi Embroidery Hoop. This means that the embroidery project does not have to be rehooped so often. It is recommended to draw guide lines on the fabric and to use the template when hooping and rehooping the material. In doing so, the guide lines must run parallel to the template. In the following example, the supplied Oval Hoop is used.

- > Select the embroidery design.
- > Tap «i-Dialog».



- > Tap «Endless Embroidery».
  - The embroidery design is multiplied in the optimum number corresponding to the embroidery hoop.
  - The reference points, which are required when rehooping the fabric, are inserted.



- > If required, use the arrow icons (1) to insert additional reference points.
- > To set the number of embroidery designs, tap «Minus»/«Plus» (2).
- > To specify the distance between the embroidery designs, tap «Minus»/«Plus» (3).
- > To automatically fit all embroidery designs into the hoop, tap «Modify to Fit Hoop» (4).



- > Tap «Confirm».



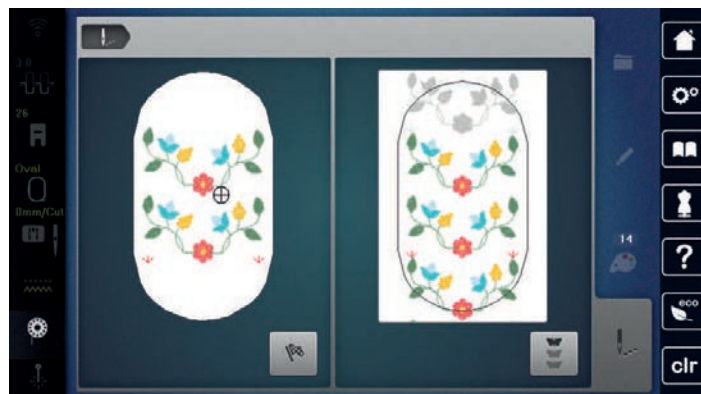
- > Tap «i-Dialog».



- > Tap «Embroidery».

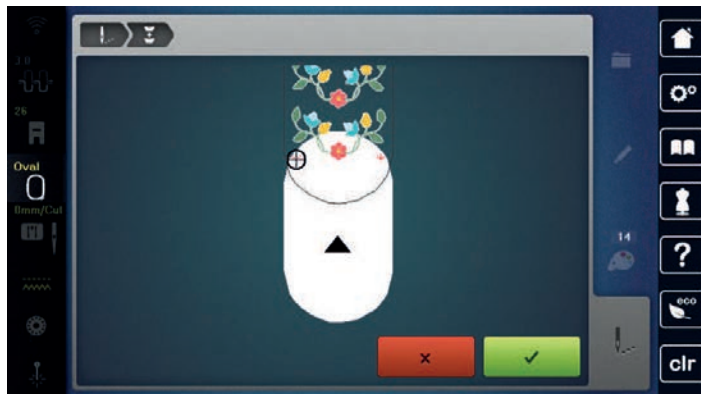


- > Press the button «Start/Stop» and embroider the border.
  - The embroidery design must be completely embroidered.





- > After the reference points have been embroidered, tap «Endless Embroidery».
  - An animation appears to indicate that the fabric needs to be rehooped.



- > Remove the hoop and hoop the fabric in such a way that the embroidered reference points are in the upper embroidery area of the hoop and the reference points are located at least 3 cm (1.18 inch) away from the upper edge of the hoop.
- > Attach the hoop.
- ✓ > Tap «Confirm».
  - The hoop is automatically moved close to the reference point.
  - The icon «AUTO» is activated, and the hoop automatically moves to the vicinity of the last reference point.
- > Use the arrow icons to determine on which side of the embroidered part the next reference point should be placed.
- > To position the embroidery hoop precisely, turn the «Upper Multi-function Knob» or the «Lower Multi-function Knob».



- > Tap «Confirm».



- > Press the button «Start/Stop» and continue embroidering.
- > Repeat these steps until the desired length of the border is completed.

### Duplicating the Embroidery Design



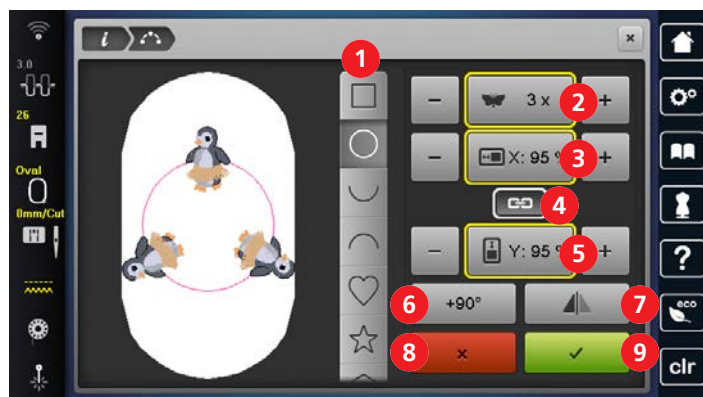
- > Select the embroidery design.
- > Tap «i-Dialog».

- > Tap «Duplicate».
- The embroidery design (1) is duplicated (2).



### Arranging Embroidery Designs

Embroidery designs can be arranged in various predefined arrangements.



- |                            |                                  |
|----------------------------|----------------------------------|
| 1 «Styles of Arrangements» | 6 «Rotating Embroidery Designs»  |
| 2 «Number of Designs»      | 7 «Mirroring Embroidery Designs» |
| 3 «Shape Width»            | 8 «Cancel»                       |
| 4 «Retain proportions»     | 9 «Confirm»                      |
| 5 «Shape Height»           |                                  |

- > Select an embroidery design or a combination.
- > Select the style how to arrange the embroidery designs.
- > Set the number of embroidery designs.
- > Set the height and the width of the arrangement.
- > Rotate or mirror the embroidery design. When rotating, the embroidery design is rotated clockwise in 90° steps. When mirroring, every second embroidery design is mirrored horizontally

### Deleting an Embroidery Design

The active embroidery design is deleted.

- > Select the embroidery design.
  - > Tap «i-Dialog».
- > Tap «Deleting».

## Undoing Entries

All entries can be undone step by step and restored as well.

Prerequisite:

- An embroidery design is selected and alterations have been made.



- > To undo the last entry, tap «Undo Entries».
- > To undo the last entries in sequence, tap «Undo Entries» several times.

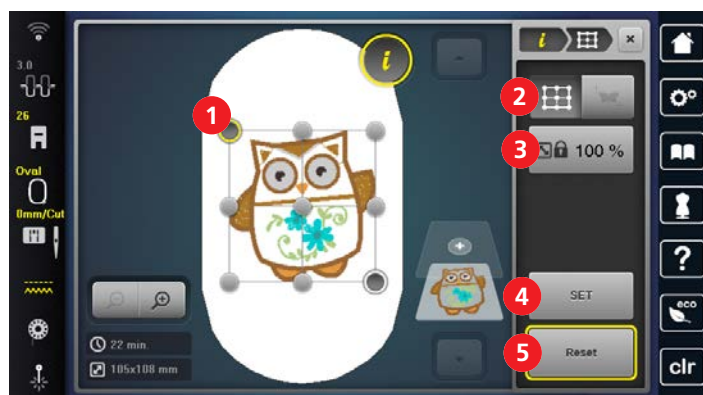


- > To restore the last entry, tap «Redo Entries».
- > To restore the last entries in sequence, tap «Redo Entries» several times.

## 15.6 Pinpoint Placement

### Positioning the Embroidery Design with the help of 2 Grid Points

This function allows embroidery designs to be positioned exactly on the fabric with the help of 2 grid points.



- |   |                                       |   |             |
|---|---------------------------------------|---|-------------|
| 1 | Grid Point                            | 4 | «Set»       |
| 2 | «Grid Point Positioning»              | 5 | «Resetting» |
| 3 | «Maintain the Embroidery Design Size» |   |             |

Prerequisite:

- Any two points of the embroidery design are marked on the fabric with chalk or a water-soluble pen. The place or the location where the embroidery design is to be positioned is clearly visible.
- The mounted embroidery hoop is selected.

- > Select the embroidery design.
- > Adjust the size of the embroidery design to fit into the hoop, as well as the position and the alignment.
- > Tap «i-Dialog».



- > Tap «Pinpoint Placement».



- > Tap «2-point Placement».



- > Tap «Grid Point Positioning».
- The embroidery design is given a grid with grid points.

- > Select the first grid point (point of rotation) and position the needle over the corresponding marking on the fabric using the multi-function knobs. For the precise positioning of the needle, the laser can be switched on.



- > To confirm the position, tap «Set».
- The point changes color and is set.
- > Select the second grid point and position the needle over the corresponding marking on the fabric.

SET

- > To confirm the position, tap «Set».
  - The marking of the points is reset.
  - In order to further adjust the placement of the embroidery design, the points can be set again.
  - The embroidery design is placed and can be embroidered.

### Positioning the Embroidery Design by means of 2 freely positioned Points

This function allows embroidery designs to be positioned exactly on the fabric with the help of 2 freely positioned points.



- |   |                                       |   |             |
|---|---------------------------------------|---|-------------|
| 1 | Positioning Point                     | 4 | «Set»       |
| 2 | «Free Point Positioning»              | 5 | «Resetting» |
| 3 | «Maintain the Embroidery Design Size» |   |             |

Prerequisite:

- Any two points of the embroidery design are marked with chalk or a water-soluble pen on the fabric. The place or the location where the embroidery design is to be positioned is clearly visible.
- The mounted embroidery hoop is selected.

- > Select the embroidery design.
- > Adjust the size of the embroidery design to fit into the hoop, as well as the position and the alignment.
- > Tap «i-Dialog».



- > Tap «Pinpoint Placement».



- > Tap «2-point Placement».



- > Tap «Free Point Positioning».
- > Set the first point (point of rotation) within the embroidery design.
  - The positioning point is displayed.

- > Via the multi-function knobs, position the needle over the corresponding marking on the fabric. For the precise positioning of the needle, the laser can be switched on.

SET

- > To confirm the position, tap «Set».
  - The point changes color and is set.

- > Select the second positioning point of the embroidery design and position the needle over the corresponding marking on the fabric.

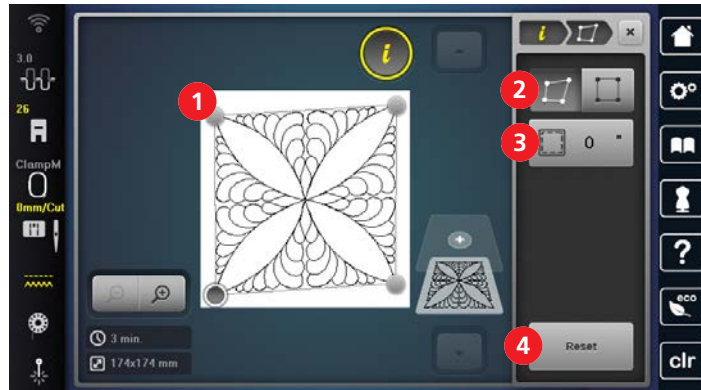
SET

- > To confirm the position, tap «Set».
  - The points will be hidden.
  - In order to further adjust the placement of the embroidery design, the points can be set again.
  - The embroidery design is placed and can be embroidered.



## Placing an Embroidery Design into a Square in a deformed Shape

This function allows embroidery designs to be placed exactly on the fabric in a square boundary. In the process, the embroidery design is inserted within the boundary and morphed to fit.



- |   |              |   |                  |
|---|--------------|---|------------------|
| 1 | Corner Point | 3 | «Margin Spacing» |
| 2 | «Morph»      | 4 | «Resetting»      |

### Prerequisite:

- The four corner points of the embroidery design are marked on the fabric with chalk or a water-soluble pen. The place or the location where the embroidery design is to be positioned is clearly visible.
  - The attached embroidery hoop is selected.
- > Select the embroidery design.  
 > Adjust the size of the embroidery design to fit into the hoop, as well as the position and the alignment.  
 > Tap «i-Dialog».



- > Tap «Pinpoint Placement».



- > Tap «4-point Placement».



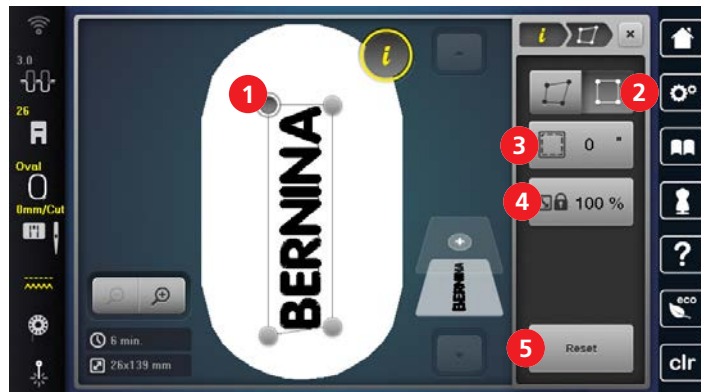
- > Tap «Morph».  
 > Select one of the corner points and position the needle over the corresponding marking on the fabric via the multi-function knobs. For the precise positioning of the needle, the laser can be switched on.  
 > Select the next corner point and position the needle.



- > If necessary, adjust the margin spacing.  
 – The embroidery design is placed and can be embroidered.

## Positioning the Embroidery Design proportionally in a Square

This function allows embroidery designs to be placed exactly on the fabric in a square boundary. In this process, the embroidery design is inserted proportionally and centered within the boundary.



- |   |                  |   |                                       |
|---|------------------|---|---------------------------------------|
| 1 | Corner Point     | 4 | «Maintain the Embroidery Design Size» |
| 2 | «Fit»            | 5 | «Resetting»                           |
| 3 | «Margin Spacing» |   |                                       |

Prerequisite:

- The four corner points of the embroidery design are marked on the fabric with chalk or a water-soluble pen. The place or the location where the embroidery design is to be positioned is clearly visible.
  - The attached embroidery hoop is selected.
- > Select the embroidery design.
- > Adjust the size of the embroidery design to fit into the hoop, as well as the position and the alignment.
- > Tap «i-Dialog».



- > Tap «Pinpoint Placement».



- > Tap «4-point Placement».



- > Tap «Fit».

> Select one of the corner points and position the needle over the corresponding marking on the fabric via the multi-function knobs. For the precise positioning of the needle, the laser can be switched on.

> Select the next corner point and position the needle.



- > If necessary, adjust the margin spacing.
- The embroidery design is placed and can be embroidered.

## 15.7 Combining Embroidery Designs

### Combining Embroidery Designs

Several embroidery designs can be combined with each other.

- > Select the embroidery design.



> Tap «Adding an Embroidery Design».



> Select another embroidery design.

### Deleting a Single Embroidery Design

Prerequisite:

- A combination of embroidery designs has been created.
- > Tap the desired embroidery design in the area of the embroidery design level (1), keep it touched and drag it outwards.
- A new window opens.



> To delete the selected embroidery design, tap «Confirm».

### Duplicating the Embroidery Design

- > Select an embroidery motif.
- > Tap «i-Dialog».



- > Tap «Duplicate».
- The embroidery motif (1) is duplicated (2).





## Duplicating a Combination

When a combination is duplicated, the individual embroidery designs cannot be selected anymore.



- > Select the embroidery design.
- > Tap «Adding an Embroidery Design».
- > Select another embroidery design.
- > Select the combination (1).



- > Tap «i-Dialog».



- > Tap «Duplicate».
  - The combination is duplicated (2).



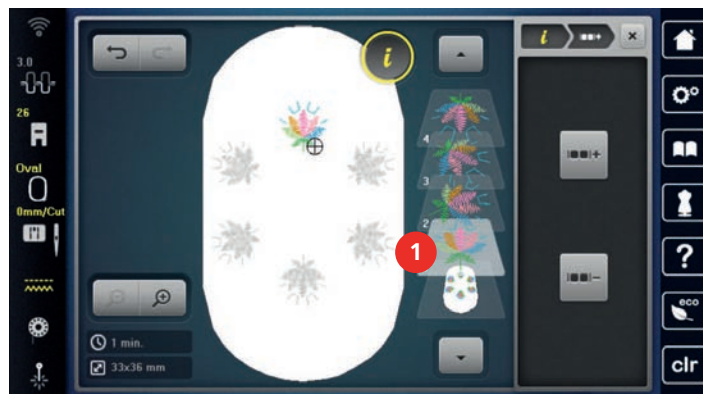
## Grouping Embroidery Designs

Embroidery motifs can be added to or removed from a group. The grouped embroidery motifs can be processed in the same way as for one embroidery motif.

The sequence of the embroidery motifs in the group can be changed. (see page 163)

If the grouping of an embroidery motif has been canceled, i.e. the embroidery motif has been broken down into different elements/colors, the colors are no longer combined for new groupings. With alphabets, the length of the connecting stitches must first be set to 1 in the setup. The cancellation of the group then works for all letters.

- > Create an embroidery motif combination.
- > Select the embroidery motif (1) in the embroidery motif combination.



- > Tap «i-Dialog».



- > Tap «Group Embroidery Designs».



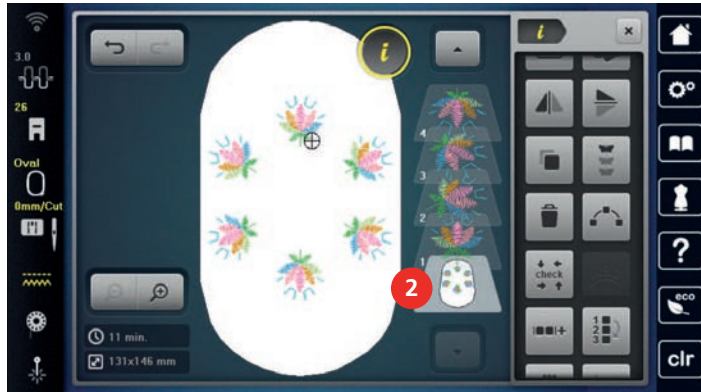
- > Tap «Group».
  - Embroidery motifs above the selected embroidery motif are added to the embroidery motif group.



- > Select the embroidery motif group.
- > Tap «Ungroup».
- The grouping is canceled.

or

- > Create an embroidery motif combination.
- > Select all embroidery motifs (2).



- > Tap «i-Dialog».

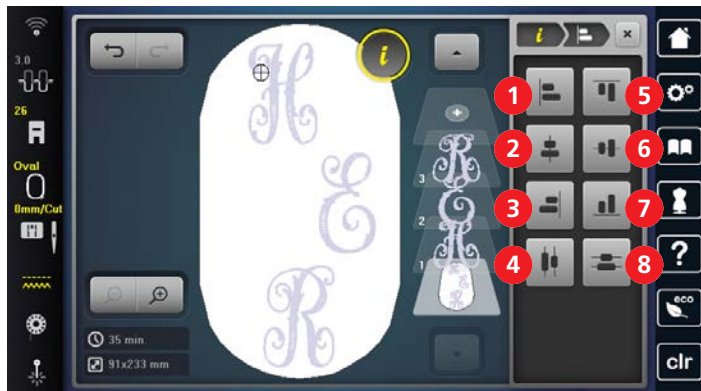


- > Tap «Group».
- All embroidery motifs are added to the embroidery motif group.



- > Select the embroidery motif group.
- > Tap «Ungroup».
- The grouping is canceled.

## Align the Embroidery Design



- |                                      |                                    |
|--------------------------------------|------------------------------------|
| 1 «Align Horizontally Left»          | 5 «Align Vertically at the Top»    |
| 2 «Align Horizontally Centered»      | 6 «Align Vertically Centered»      |
| 3 «Align Horizontally Right»         | 7 «Align Vertically at the Bottom» |
| 4 «Distribute Horizontally Centered» | 8 «Distribute Vertically Centered» |

Prerequisite:

- The embroidery design combination has been created or the motif has been ungrouped.

- > Select a combination.
- > Tap «i-Dialog».



- > Tap «Align the Embroidery Design».
- > To align the embroidery designs.

## Changing the Sequence within an Embroidery Design Combination

The sequence of the embroidery designs in the embroidery design combination can be changed.

Prerequisite:

- The embroidery design combination has been created or the motif has been ungrouped.



> Tap «i-Dialog».












> Tap «Change Embroidery Design Sequence».

> Select the required embroidery design and use the arrows to move it to the desired position.

## 15.8 Creating Lettering

### Overview Embroidery Alphabets

Embroidery Designs		Name
<b>ABC</b>		Rounded Sans
<i>ABC</i>		Curly
<b>ABC</b>		Deco Block
<b>ABC</b>		Condensed Sans
<b>ABC</b>		Happy Times
<b>ABC</b>		Bamboo
<i>ABC</i>		Lisa
<i>ABC</i>		Zuerich
<b>ABC</b>		Flare Serif
<i>ABC</i>	<i>A B C</i>	Anniversary
<b>ABC</b>	<b>A B C</b>	Swiss Block
ABC		Quilt Block
<b>ABC</b>		Old English
ABC		King Charles

Embroidery Designs		Name
		Alice
		Drifter
		Childs Play
		Victoria
		Chicago
		Russian Textbook

### Creating Lettering



- |                           |   |
|---------------------------|---|
| 1 «Line Up»               | 7 «Lower Case Characters»               |
| 2 Entry Field             | 8 «Numbers and Mathematical Characters» |
| 3 «Line Down»             | 9 «Special Characters»                  |
| 4 «Deleting»              | 10' «Cancel»                            |
| 5 Line Change             | 11 «Confirm»                            |
| 6 «Upper Case Characters» |   |



A lettering is always embroidered in one color. To embroider individual letters or individual words in a different color, the grouping must be canceled.

Lettering can be positioned within the hoop as you like. If the embroidery design is positioned outside the embroidery area, the embroidery hoop is outlined in red on the display. Use the hoop selection to check whether the embroidery design can be embroidered with another hoop. If a lettering does not fit into an embroidery hoop, for example, individual lines of the text can be combined and positioned one below the other. With the line break, lettering of up to 10 lines is possible.



- > Select «Alphabets».
- > Select an alphabet.
- > Enter and confirm the text.

### Editing a Single-Line Lettering



1 «Character Spacing»

2 «Text Bending»

Prerequisite:

- A single-line lettering has been created.
- > Select the embroidery design.
- > Tap «i-Dialog».



- > Tap «Word Art».
- > Edit the lettering. The character spacing as well as text bending can be adjusted with the multi-function knobs.

### Editing Multi-Line Lettering



1 «Character Spacing»

4 «Align the Text to the Center»

2 «Line Spacing»

5 «Align the Text to the Right»

3 «Align the Text to the Left»

Prerequisite:

- A multi-line lettering has been created.



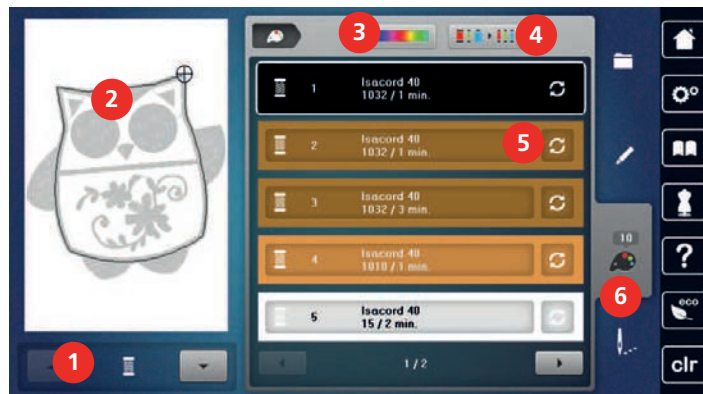
- > Select the embroidery design.
- > Tap «i-Dialog».



- > Tap «Word Art».
- > Edit the lettering. The character spacing and the line spacing can be set with the multi-function knobs.

## 15.9 Changing the Colors of the Embroidery Design

### Overview Changing the Color



- |   |                            |   |                        |
|---|----------------------------|---|------------------------|
| 1 | «Color Indication»         | 4 | «Assign Thread Brand»  |
| 2 | Preview for Selected Color | 5 | «Altering Color/Brand» |
| 3 | «Color Wheel»              | 6 | «Color Information»    |

### Changing the Colors



A lettering is always embroidered in one color. To embroider individual letters or individual words in a different color, the grouping must be canceled.



- > Select the embroidery design.
- > Tap «Color Information».



- > Tap «Altering Color/Brand» next to the color that needs to be changed.



- > To select the color by entering the color number, tap «Color Selection via Number».
- > Select the desired color.



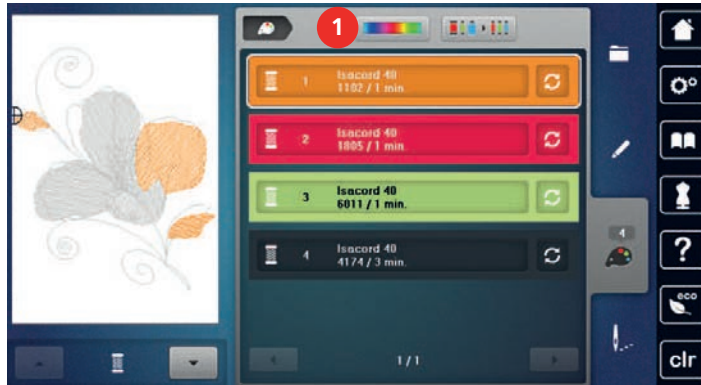
- > To apply the color choice, tap «Color Information».

### Altering the Colors via the Color Wheel

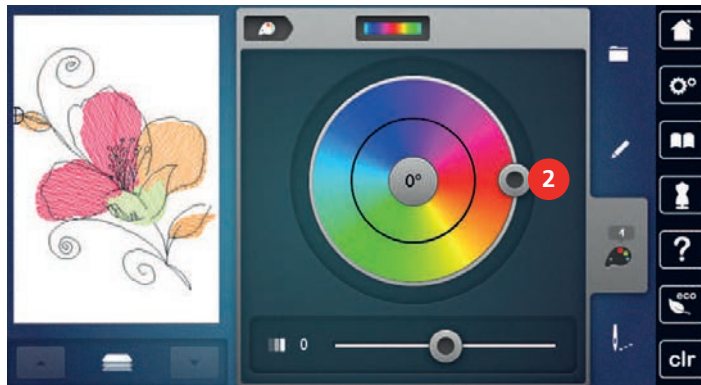


- > Tap «Color Information».

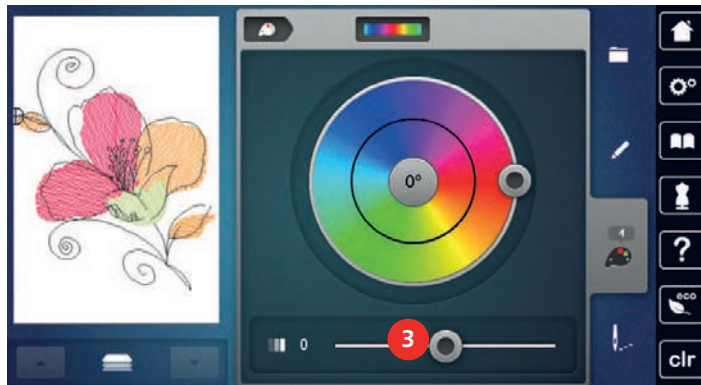
- > Tap «Color Wheel» (1).



- > To change the colors of the embroidery design, turn the knob (2) clockwise or counterclockwise.



- > To undo the changes, tap the value in the center of the color circle.
- > To modify the brightness of the colors, move the slider (3).



- > Tap «Edit».
  - The settings are applied, and the embroidery design can be seen in the new colors.

### Changing the Thread Brand



- > Select the embroidery design.
- > Tap «Color Information».



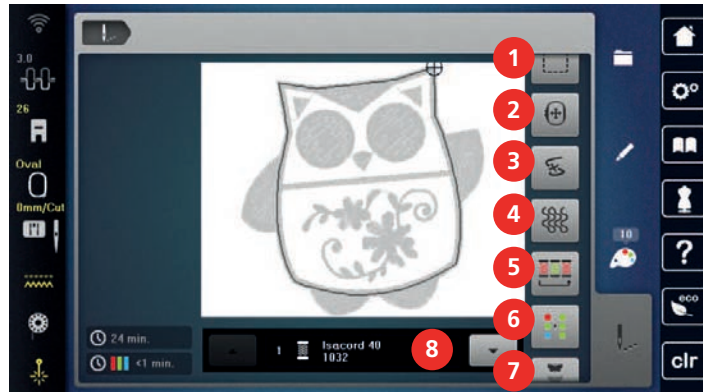
- > Tap «Altering Color/Brand».
- > To display other thread brands, scroll to the left and to the right.



- > Tap «Assign Thread Brand».
  - Any thread colors of the selected embroidery design will be matched with the selected thread brand.

## 15.10 Embroidering the Embroidery Design

### Overview Selection Menu Embroidering



- |   |                               |   |  |
|---|-------------------------------|---|--|
| 1 | «Basting»                     | 5 | «Reduce Color Changes»                   |
| 2 | «Move the Hoop»               | 6 | «Multi-colored Embroidery Design On/Off» |
| 3 | «Embroidery Sequence Control» | 7 | «Endless Embroidery»                     |
| 4 | «Quilt Settings»              | 8 | «Color Indication»                       |

### Adding Basting Stitches

The basting stitches can be embroidered along the embroidery design. This provides a stronger connection between the fabric and the stabilizer.



- > Select the embroidery design.
- > Tap «Embroidery».



- > To embroider the basting stitches along an embroidery design, tap «Basting».



- > To embroider the basting stitches along an embroidery design, tap «Baste along the Embroidery Design».



- > To deactivate the basting stitches, tap «Base along the Hoop».

### Moving the Hoop

If the embroidery design is so big that repeated rehooping is necessary, the embroidered design can be moved again.



- > Select the embroidery design.
- > Tap «Embroidery».



- > Tap «Move the Hoop».
- > Turn the «Upper Multi-function Knob» to move the embroidery design horizontally.
- > Turn the «Lower Multi-function Knob» to move the embroidery design vertically.



- > To accept the settings, tap «Embroidery» in the Process Navigation.

### Embroidery Sequence Control When Thread Breaks

If the thread breaks, the needle can be repositioned in the embroidery design using the function Embroidery Sequence Control.

- > Select the embroidery design.





- > Tap «Embroidery».



- > Tap «Embroidery Sequence Control».
  - A compact view of the embroidery design appears on the left side of the display. On the right side the embroidery design is shown in enlarged view.
- > Select the desired position in the compact view.
- > To move the hoop stitch by stitch, turn the «Upper Multi-function Knob».
- > To move the hoop in large steps, turn the «Lower Multi-function Knob».
  - The number in the yellow-outlined icon indicates the number of stitches within the embroidery sequence.



- > To select the desired stitch by entry, tap the icon «Stitch Position via Number».

### Activating Quilting Settings

The function is deactivated by default, and the settings for thread cutting are taken from the embroidery settings in the Setup Program. When the function is activated, the settings required for quilting become active, regardless of any settings in the Setup Program:

- Particular securing stitches (unless the embroidery design contains programmed securing stitches)
- The thread cut is inactive
- Thread-away is deactivated

- > Select the embroidery design.



- > Tap «Embroidery».



- > To activate the function, tap «Quilt Settings».
- > To deactivate the function, tap «Quilt Settings» again.

### Reducing Color Changes

If the embroidery designs overlap, the color changes **cannot** be reduced.

- > Select the embroidery design.



- > Tap «Embroidery».



- > Tap «Reduce Color Changes».
  - Identical colors of the embroidery design are collected to one color.
  - If the embroidery design is not completed and the machine is switched off, the function must be activated again before embroidering is continued.

### Multi-colored Embroidery Design On/Off

Multi-colored embroidery designs can also be embroidered in one color.

- > Select the embroidery design.



- > Tap «Embroidery».



- > Tap «Multi-colored Embroidery Design On/Off».
  - The embroidery design is embroidered in one color.

### Endless Embroidery

This makes it possible to embroider trims that have already been started, even if the machine has been switched off and on.

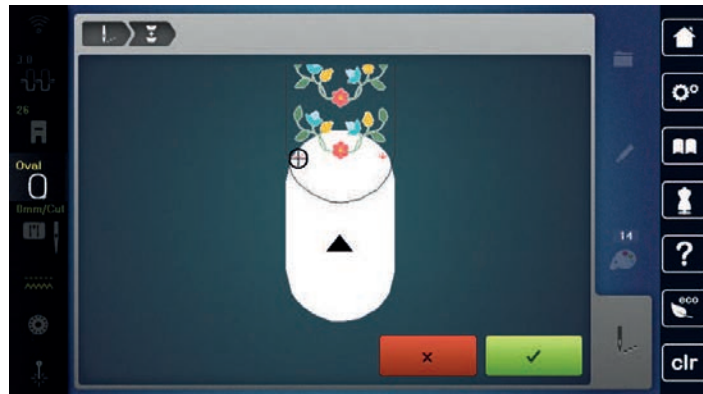
Prerequisite:

- A trim embroidery design must be saved on a separate storage medium. The reference points must be included in the embroidery design.

- > Select trim embroidery designs from the separate storage medium.
- > Tap «Embroidery».



- > Tap «Endless Embroidery».



- > Remove the hoop and spin the fabric in such a way that the embroidered reference points are in the upper embroidery field of the hoop and the reference points are located at least 3 cm (1.18 inch) away from the upper edge of the hoop.

- > Attach the hoop.



- > Tap «Confirm».

– The hoop is automatically moved close to the last stitch.

– The icon «AUTO» is active and the hoop automatically moves close to the last reference point.

- > Use the arrow icons to determine the side of the embroidered section on which you want to position the next reference point.

- > To position the embroidery hoop precisely, turn the «Upper Multi-function Knob» or the «Lower Multi-function Knob».



- > Tap «Confirm».



- > Press the button «Start/Stop» and continue embroidering.

- > Repeat these steps until the required length of the trim has been achieved.

### Color Indication

Every color of the embroidery design can be selected individually. The hoop moves to the first stitch of the current color. The currently active color can be embroidered individually or in another sequence.

- > Select the embroidery design.



- > Tap «Embroidery».

- > Touch the icon Scroll up to select the previous color of the embroidery design.

## 15.11 Freearm Embroidery

Free arm embroidering is defined as embroidering tubular fabrics or garments which are positioned around the free arm of the embroidery machine while being embroidered. Often used with sleeves, pant legs or other narrow-tailored garments.



A fabric tube can be conveniently placed around the freearm of the machine if the embroidery hoop is moved to the left into the park position before attaching or removing it. To return the hoop to the embroidery position afterwards, push the button «Start/Stop».

If possible, use a full bobbin as the embroidery hoop must be removed when the bobbin is changed.

Borders can be closed easily and exactly along the edge of the tube to form a ring. Before working out the last embroidery design, after rehooping the fabric, activate the function «Pinpoint Placement» in the Edit Mode. Use the sub-function «Free Point Positioning» to insert the missing embroidery design for a perfect fit.

The movability of the embroidery arm can be limited or impeded with very narrow tubes. Therefore please make sure that the embroidery hoop can move forwards and backwards sufficiently. An impediment of the embroidery arm caused by a tube which is too tight can result in embroidery design offset or in damaging the fabric.

### Check the Movability of the Freearm

Please note: With tiny fabric tubes, deactivate the thread-away in the Setup Program if necessary.

- > Open the embroidery design on the machine and edit as desired.
- > Mark the embroidery design position and the size on the fabric in a suitable way.
- > Select the embroidery hoop as small as possible.
- > Hoop or stick the fabric along with the appropriate stabilizer in the embroidery hoop, depending on the stabilizer.
- > Pull the fabric tube carefully over the freearm of the machine and attach the embroidery hoop at the clutch of the embroidery module.
- > If necessary, reposition the embroidery design.
- > Tap «Check Embroidery Design Size».
- > After the successful check of the embroidery design size, start the embroidery process.



## 15.12 Administering Embroidery Designs

### Administering Embroidery Designs



- |   |                                 |   |                               |
|---|---------------------------------|---|-------------------------------|
| 1 | «Loading the Embroidery Design» | 3 | «Save Embroidery Design»      |
| 2 | «Adding an Embroidery Design»   | 4 | «Delete an Embroidery Design» |

### Saving Embroidery Designs in the Personal Memory

In the file «Save Embroidery Designs» any embroidery designs including individually edited embroidery designs can be saved.

- > Select the embroidery design.
- > Edit the embroidery design.
- > Tap «Selection».



- > Tap «Save Embroidery Design».
- The embroidery design to be saved is outlined in yellow.



- The «Embroidery Machine» is activated.



- > Tap «Confirm».

### Saving the Embroidery Design on the BERNINA USB Stick

- > Select the embroidery design.
- > Edit the embroidery design.
- > Tap «Selection».



- > Tap «Save Embroidery Design».
- The embroidery design to be saved is outlined in yellow.

- > Insert the BERNINA USB stick into the USB port of the machine.



- > Tap «USB Stick».



- > Tap «Confirm».

### Overwriting the Embroidery Design in the Personal Memory

- > Select the embroidery design.
- > Edit the embroidery design.
- > Tap «Selection».



- > Tap «Save Embroidery Design».
- The embroidery design to be saved is outlined in yellow.



- The «Embroidery Machine» is activated.

- > Select the embroidery design which is to be overwritten.



- > Tap «Confirm».

### Overwriting the Embroidery Design on the BERNINA USB Stick

- > Select the embroidery design.
- > Edit the embroidery design.
- > Tap «Selection».



- > Tap «Save Embroidery Design».
- The embroidery design to be saved is outlined in yellow.

- > Insert the BERNINA USB stick into the USB port of the machine.



- > Tap «USB Stick».

- > Select the embroidery design which is to be overwritten.



- > Tap «Confirm».

## Importing Stitch Patterns

Stitch patterns or stitch pattern combinations can be imported from sewing mode into embroidery mode and edited like embroidery designs. For example, border designs can be quickly and easily created and saved as embroidery designs in the folder «Personal embroidery designs».



> Tap «Home».



> Tap «Sewing Mode».  
> Select the stitch pattern.



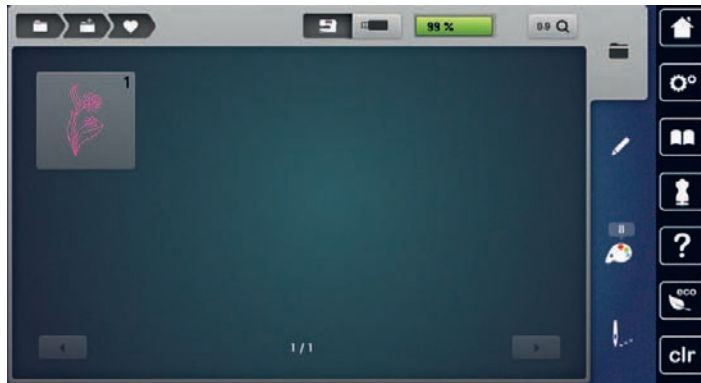
> Tap «Home».



> Tap «Embroidery Mode».  
– The stitch pattern is automatically stored in the folder «Personal Embroidery Design».



> Select «Personal Embroidery Design».  
> Select the stitch pattern.



## Loading an Embroidery Design from the Personal Memory



> Tap «Selection».



> Tap «Loading the Embroidery Design».



> Select «Personal Embroidery Design».  
> Select the embroidery design.

## Loading an Embroidery Design from the BERNINA USB Stick



> Tap «Selection».  
> Insert the BERNINA USB stick into the USB port of the machine.



> Tap «Loading the Embroidery Design».



> Tap «USB Stick».  
> Select a personal embroidery design.

## Deleting an Embroidery Design from the Personal Memory

The embroidery designs which are saved in the personal memory can be deleted individually.



> Tap «Selection».



> Tap «Deleting».



– The «Embroidery Machine» is activated.

> Select the embroidery design which is to be deleted.



> Tap «Confirm».

## Deleting an Embroidery Design from the BERNINA USB Stick



> Tap «Selection».



> Tap «Deleting».

> Insert the BERNINA USB stick into the USB port of the machine.



> Tap «USB Stick».

> Select the embroidery design which is to be deleted.





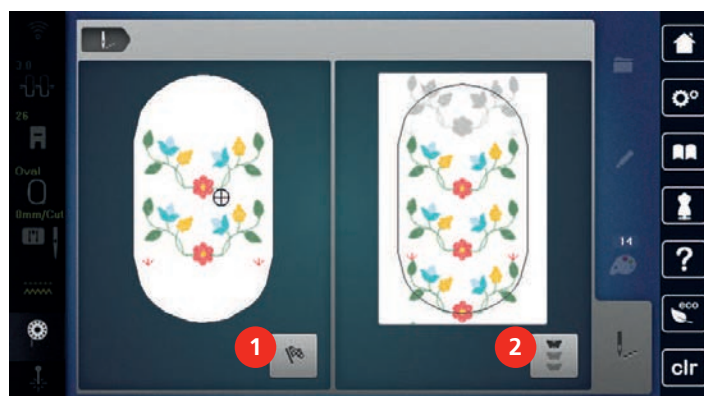
> Tap «Confirm».

## 16 Embroidery

### 16.1 Embroidering via the Button «Start/Stop»

In case of a power cut the embroidery process is interrupted. After the restart the machine goes to the position which was embroidered last.

- 
  - > Push the button «Start/Stop» until the embroidery machine starts.
    - All parts of the design being in the current color are embroidered.
    - The embroidery machine stops automatically at the end.
    - Both threads are cut automatically.
    - The embroidery machine switches to the next color automatically.
- 
  - > Change the upper thread.
  - > To embroider the new color, push the button «Start/Stop».
  - > After completing the embroidery design, finish the embroidering process by tapping the icon «Completing the Embroidering Process» (1) or embroider the embroidery design again as trim by tapping the icon «Endless Embroidery» (2).




### 16.2 Increasing the Embroidery Speed

To ensure the best embroidery quality, the speed when embroidering is reduced depending on the embroidery position. Choose between the two options to either embroider at optimal or maximum speed. Standard = optimal speed. It has to be considered that the quality of the embroidered embroidery design at maximum speed cannot be ensured.

By switching the machine off and on, the optimal embroidery speed is activated.

Prerequisite:

- Embroidering has started.
- 
  - > Tap «Embroidery Speed».
    - The maximum speed is activated.
  - > Tap «Embroidery Speed» again.
    - The optimal speed is activated.

### 16.3 Adjusting the Upper Thread Tension

The default setting of the upper thread tension is set automatically as soon as a stitch pattern or an embroidery motif is selected.

When of using other types of sewing or embroidery threads, the optimal tension may vary. Therefore it may be necessary to adjust the upper thread tension according to the sewing or embroidering project as well as the desired stitch pattern or the embroidery motif individually.

The higher the upper thread tension, the tighter the upper thread which means that the bobbin thread is pulled up to the top of the fabric. When the upper thread tension is low, the upper thread is less tightened which means that the bobbin thread is pulled up less.

Alteration of the upper thread tension affect the currently selected stitch pattern and all embroidery motifs. Permanent alterations of the upper thread tension for the Sewing Mode (see page 51) and for the Embroidering Mode (see page 54) can be made in the Setup Program.



- > Tap «Upper Thread Tension».
- > Adjust the upper thread tension.



- > Tap the yellow-outlined icon on the right side to reset the alterations to the default setting.
- > Tap the yellow-outlined icon on the left side to reset the alteration to default setting in the **Setup Program**.

## 16.4 Embroidering via the Foot Control

Embroidering with the foot control is recommended if small sequences are to be embroidered, e. g. for stumpwork.

- > To start embroidering, press and keep the foot control pressed.



## 17 Care and Maintenance

### 17.1 Firmware

#### Checking the Firmware Version

The firmware and hardware versions of the machine and the connected embroidery module are displayed.



> Tap «Setup Program».



> Tap «Machine Settings».



> Tap «Information».



> Tap «Machine Data».

#### Updating Firmware



The machine's current firmware and detailed step-by-step instructions for the update process can be downloaded from [www.bernina.com](http://www.bernina.com). In general, personal data and settings are automatically transferred during a firmware update. For reasons of safety, it is also recommended to save data and settings on a BERNINA USB stick before the firmware update is started. If personal data and settings should get lost during a firmware update, they can be transferred to the machine again afterwards.

Prerequisite:

- Accessories such as the Embroidery module or the BSR Foot which are connected to the machine have been removed.

> Insert the USB stick with the new firmware version into the machine.



> Tap «Setup Program».



> Tap «Machine Settings».



> Tap «Maintenance/update».



> Tap «Updating firmware».



> To start the firmware update, tap «Update».

**Please note:** The update can take several minutes. During the update, do not switch the machine off and do not remove the USB stick.

- The machine restarts. Once the update is complete, a message appears.

#### Recovering Saved Data

If personal data and settings after a software update are not available anymore, they can be transferred to the machine again afterwards.

> Insert the BERNINA USB stick providing the saved data and settings into the USB port of the machine.



> Tap «Setup Program».



> Tap «Machine Settings».



> Tap «Maintenance/update».



> Tap «Updating firmware».

**NOTICE**

BERNINA USB Stick (Optional Accessory) has been removed too early

Saved data cannot be transferred and the machine cannot be used.

- > Remove the BERNINA USB stick (optional accessory) only after the saved data has been transferred successfully.



> Tap «Load Data».

- After the data has been transferred, a green tick is temporarily displayed.

## 17.2 Machine

### Cleaning the Display

- > Clean the display when it is switched off with a soft slightly damp microfiber cloth.

### Cleaning the Feed Dog

Remaining threads under the stitch plate must occasionally be removed.

- > Raise the needle and presser foot.

**CAUTION**

### Electronically Driven Components

Risk of injury near the needle and the hook.

- > Switch the machine off and disconnect it from the power supply system.

- > Remove the needle and presser foot.
- > Lower feed dog.



- > Remove the stitch plate.

**NOTICE**

### Dust and Thread Residues Inside the Machine

Damage to mechanical and electronic components.

- > Use a brush or a soft cloth.
- > Do not use compressed air spray.

- > Clean the feed dog with the brush.

## Cleaning the Hook

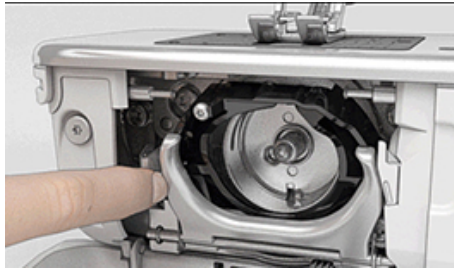
### CAUTION

#### Electronically Driven Components

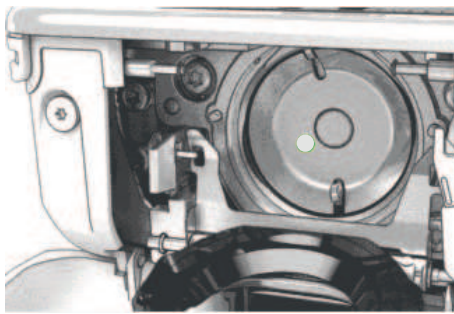
Risk of injury near the needle and the hook.

> Switch the machine off and disconnect it from the power supply system.

- > Open the hook cover.
- > Remove the bobbin case.
- > Push the release lever to the left.



- > Flap down the locking bracket with the black hook race cover.
- > Remove the hook.



### NOTICE

#### Dust and Thread Residues Inside the Machine

Damage to mechanical and electronic components.

- > Use a brush or a soft cloth.
  - > Do not use compressed air spray.
- 
- > Clean the hook race area with a brush and a soft cloth. Never use any sharp instruments.
  - > Hold the hook at the pin in the center with two fingers.
  - > Bring the hook diagonally from top to bottom behind the hook race cover with the lower edge first.
  - > Position the hook so that the two lugs on the hook driver fit into the corresponding openings on the hook, and the colored marking on the hook driver is visible in the hole of the hook.
  - > Insert the hook.
    - The hook is magnetic and therefore fastened to the correct position.
  - > Close the hook race cover and the fastening bracket until the release bracket engages.
  - > As a check, turn the handwheel.
  - > Insert the bobbin case.

## Lubricating the Hook

By oiling the hook, the occurrence of unwanted noises in the hook area can be avoided. BERNINA recommends oiling the hook at the following intervals:

- Before using the machine for the first time
- After a longer downtime of the machine
- For intensive use: Daily before sewing
- When the message " Lubricate the Machine " is displayed
- In case of unwanted noises in the hook area

**CAUTION**

### Electronically Driven Components

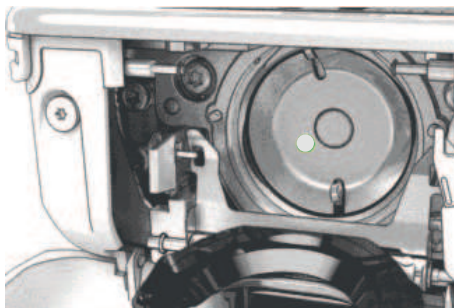
Risk of injury near the needle and the hook.

- > Switch the machine off and disconnect it from the power supply system.

- > Remove the bobbin case.
- > Push the release bracket to the left.



- > Flap down the fastening bracket along with the black hook race cover.
- > Remove the hook.



- > Clean the hook race area with a brush and a soft cloth. Never use any sharp instruments.
- > Add one drop of BERNINA oil down into the hook race.



- > Add one drop of oil into each of the two oil depots so that the felts are damp, and make sure that the red-marked surface of the hook sleeve remains free of oil.



- > Hold the hook at the pin in the center with two fingers.
- > Guide the hook with the lower edge diagonally from the top to the bottom behind the hook race cover.
- > Position the hook so that the two lugs on the hook driver fit into the corresponding openings on the hook, and the colored marking on the hook driver is visible in the hole of the hook.
- > Insert the hook.
  - The hook is magnetic and therefore fastened to the correct position.

- > Close the hook race cover and the fastening bracket until the release bracket engages.
- > As a check, turn the handwheel.
- > Insert the bobbin case.
- > Sew or embroider on a test fabric.

### Cleaning the Thread Catcher



- > Tap «Setup Program».



- > Tap «Machine Settings».



- > Tap «Maintenance/update».



- > Tap «Cleaning the Thread Clamp/Thread Catcher».



- > Tap «Cleaning the Thread Catcher».
- > Clean the thread catcher according to the instructions on the display.

### Clean the Needle Threader

Depending on the sewing thread, the machine may become soiled by thread residue. Thread residues on the automatic needle threader can impair the threading process and should be removed.

- > Remove the needle.
- > Tap «Setup Program».



- > Tap «Machine Settings».



- > Tap «Maintenance/update».



- > Tap «Cleaning the Needle Threader/Thread Catcher».



- > Tap «Clean the Needle Threader».



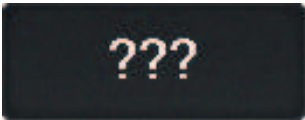


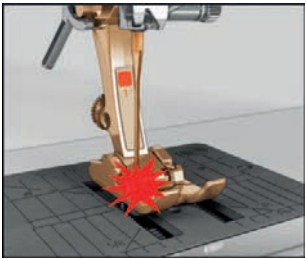



- > Push the button «Automatic Needle Threader».
- > Carefully remove thread residues in the thread clamp and on the threader hook with a brush and tweezers.


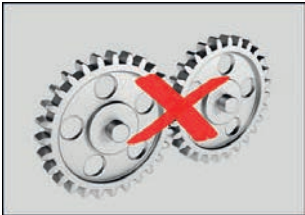
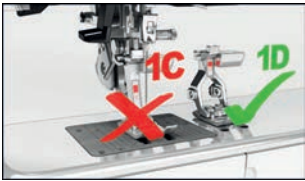
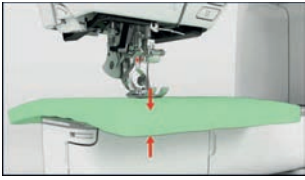
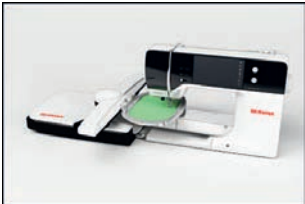
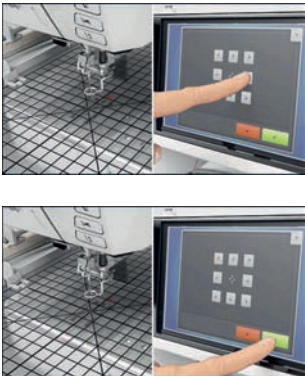



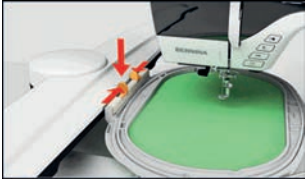
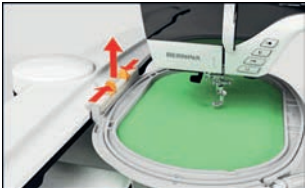
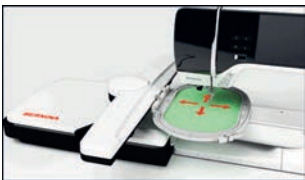


- > Push the button «Automatic Needle Threader» again.

## 18 Errors and Faults


### 18.1 Error Messages



Message on the Display	Cause	Solution
	Stitch number unknown.	> Check the entry and enter the new number.
	Selection of stitch patterns not possible in Combi-mode.	> Combine other stitch patterns.
	The feed dog is not lowered.	> Push the button «Feed Dog Up/Down» to lower the feed dog.
	The selected needle and stitch plate cannot be used in combination.	> Replace the needle. > Replace the stitch plate.
	The selected presser foot does not match with the fitted presser foot.	> Select the fitted presser foot in the presser foot selection or change the presser foot.
	The needle is not at its top end.	> Adjust the needle position via the handwheel.
	The upper thread is used up.	> Rethread.
	The upper thread has broken.	> Rethread.

Message on the Display	Cause	Solution
	The bobbin thread is used up.	> Rethread.
	The bobbin thread has broken.	> Clean the hook. > Rethread.
	The main motor is not running.	<ul style="list-style-type: none"> <li>&gt; Turn the handwheel clockwise until the needle is at its top position.</li> <li>&gt; Remove the sewing project. Do not pull on the fabric or the thread.</li> <li>&gt; Remove the stitch plate.</li> <li>&gt; Remove the thread remnants.</li> <li>&gt; Clean the hook.</li> <li>&gt; Remove the hook and make sure that there are no pieces of broken needle points on the magnetic back of the hook.</li> <li>&gt; Insert the hook correctly.</li> </ul>
	Incorrect presser foot for the BERNINA Dual Feed.	> Fit a presser foot with the designation «D».
	The fabric under the presser foot is too thick.	> Reduce the fabric thickness.
	The contact between the machine and the embroidery module is interrupted as a result of vibrations.	<ul style="list-style-type: none"> <li>&gt; Make sure that the embroidery module and the machine are standing on a stable, even surface.</li> <li>&gt; Connect the embroidery module to the machine.</li> </ul>
	The needle position doesn't correspond with the center of the hoop.	> Calibrate the hoop.

Message on the Display	Cause	Solution
	The embroidery module is not mounted.	<ul style="list-style-type: none"> <li>&gt; Connect the embroidery module to the machine.</li> <li>&gt; Contact your authorized BERNINA dealer to have the machine checked.</li> </ul>
	The hoop is not mounted.	<ul style="list-style-type: none"> <li>&gt; Attach the hoop.</li> </ul>
	The hoop is mounted.	<ul style="list-style-type: none"> <li>&gt; Remove the embroidery hoop.</li> </ul>
	The movement of the hoop follows.	<ul style="list-style-type: none"> <li>&gt; Tap «Confirm».</li> </ul>
	The embroidery design is partly outside the hoop.	<ul style="list-style-type: none"> <li>&gt; Reposition the embroidery design and start embroidering it again.</li> </ul>
	The embroidery design is too large.	<ul style="list-style-type: none"> <li>&gt; Reduce the size of the embroidery design.</li> <li>&gt; Attach a larger hoop.</li> </ul>
Not enough free capacity on the BERNINA USB stick (optional accessory).	There is not enough free capacity on the BERNINA USB stick (optional accessory).	<ul style="list-style-type: none"> <li>&gt; Make sure that the BERNINA USB stick (optional accessory) is used.</li> <li>&gt; Delete data from the BERNINA USB stick (optional accessory).</li> </ul>
No personal data on the BERNINA USB stick (optional accessory).	No personal data for recovery available on the BERNINA USB stick (optional accessory).	<ul style="list-style-type: none"> <li>&gt; Make sure that the data and settings have been saved on the BERNINA USB stick (optional accessory).</li> </ul>



Message on the Display	Cause	Solution
The recovery of personal data has failed.	The firmware update has been successful but the personal data could not be recovered.	<ul style="list-style-type: none"> <li>&gt; Make sure that the data and settings have been saved on the BERNINA USB stick.</li> <li>&gt; Transfer saved data to the machine.</li> </ul>
No BERNINA USB stick is inserted. Make sure that the same BERNINA USB stick remains connected during the entire automatic update process.	The BERNINA USB stick (optional accessory) is not inserted.	<ul style="list-style-type: none"> <li>&gt; Use a BERNINA USB stick (optional accessory) which provides enough free capacity.</li> </ul>
The firmware update has failed.	The latest firmware version cannot be found on the USB stick.	<ul style="list-style-type: none"> <li>&gt; Make sure that the compressed zip file has been unzipped for the firmware update.</li> <li>&gt; Check whether the data for the software update is saved directly on the data medium and not in a file on the USB stick.</li> <li>&gt; Updating Firmware.</li> </ul>
	The machine must be cleaned/ lubricated.	<ul style="list-style-type: none"> <li>&gt; Clean the machine.</li> <li>&gt; Lubricate the machine.</li> </ul> <p>Important information on lubricating:</p> <ul style="list-style-type: none"> <li>&gt; Too much oil may stain the fabric and the thread.</li> <li>&gt; After lubricating, sew/embroider a test piece first.</li> </ul>
The automatic thread cutter (at the thread catcher) needs cleaning.	The automatic thread cutter needs cleaning. The message appears every time when the machine is started as soon as 1000 cutting cycles have been carried out.	<ul style="list-style-type: none"> <li>&gt; Tap «Confirm». <ul style="list-style-type: none"> <li>– The machine calls up the function «Clean the Thread Catcher».</li> </ul> </li> <li>&gt; Clean the thread catcher according to the instructions on the display. <ul style="list-style-type: none"> <li>– The counter for the cutting cycles is reset.</li> </ul> </li> </ul>

Message on the Display	Cause	Solution
It is time for the regular maintenance. Please contact your authorized BERNINA dealer to make an appointment.	<p>The machine needs maintenance. The message appears after the programmed service interval has expired.</p> <p><b>Important Information:</b> Having your machine cleaned and serviced properly at the appropriate times ensures its proper functioning and a long service life. In case of non-compliance, the service life may be negatively affected and the warranty service may possibly become limited. The cost allocation for maintenance work is regulated nationally. Consult your authorized BERNINA dealer or your service center for more details.</p>	<ul style="list-style-type: none"> <li>&gt; Contact your authorized BERNINA dealer.</li> <li>&gt; Delete the message temporarily by touching the icon «ESC».</li> </ul> <p>After the third deletion, the message is not displayed until the next service interval is reached.</p>
	<p>The calibration of the Buttonhole Foot with Slide #3A has failed.</p>	<ul style="list-style-type: none"> <li>&gt; Check the presser foot for ease of movement. If necessary, remove lint, dust and fabric remnants.</li> <li>&gt; Clean the reflector with a soft, slightly damp microfiber cloth.</li> <li>&gt; Check the position of the reflector. If necessary, correct the position of the reflector or replace the presser foot.</li> <li>&gt; Check the plastic on the underside of the presser foot for signs of wear. If necessary, replace the presser foot.</li> <li>&gt; Clean the feed dog.</li> <li>&gt; If the error still occurs, contact your authorized BERNINA dealer.</li> </ul>
	<p>The Internet connection is interrupted. Receiving messages is not possible.</p>	<ul style="list-style-type: none"> <li>&gt; Check the connection from the router to the Internet.</li> <li>&gt; Turn the WiFi on the machine off and on again.</li> <li>&gt; If the error still occurs, contact your authorized BERNINA dealer.</li> </ul>
«Connection Failed»	<p>The connection to the WiFi network could not be established.</p>	<ul style="list-style-type: none"> <li>&gt; Select the WiFi network again and enter the network name (SSID) or password correctly.</li> <li>&gt; Check the router, such as that it is switched on.</li> </ul>
«#1000»	<p>The needle threader is jammed.</p>	<ul style="list-style-type: none"> <li>&gt; Turn the handwheel counterclockwise until the needle threader is in its starting position. Restart the machine.</li> <li>&gt; If the error still occurs, contact your authorized BERNINA dealer.</li> </ul>
«#1001»	<p>The button «Thread Cutter» is stuck or defective.</p>	<ul style="list-style-type: none"> <li>&gt; Make sure that the button can be operated without restriction.</li> <li>&gt; If the error still occurs, contact your authorized BERNINA dealer.</li> </ul>

Message on the Display	Cause	Solution
«#1002»	The button «Needle position Up/Down» is stuck or defective.	<ul style="list-style-type: none"> <li>&gt; Make sure that the button can be operated without restriction.</li> <li>&gt; If the error still occurs, contact your authorized BERNINA dealer.</li> </ul>
«#1003»	The button «Start/Stop» is stuck or defective.	<ul style="list-style-type: none"> <li>&gt; Make sure that the button can be operated without restriction.</li> <li>&gt; If the error still occurs, contact your authorized BERNINA dealer.</li> </ul>
«#1004» «#1005»	The exact cause of the malfunction cannot be determined.	<ul style="list-style-type: none"> <li>&gt; Restart the machine.</li> <li>&gt; If the error still occurs, contact your authorized BERNINA dealer.</li> </ul>
«#1010»	The hook is blocked.	<ul style="list-style-type: none"> <li>&gt; Check the hook for thread tangles and insert it correctly.</li> </ul>

## 18.2 Troubleshooting

Fault	Cause	Solution
<b>Uneven Stitch Formation</b>	Upper thread too tight or too loose.	<ul style="list-style-type: none"> <li>&gt; Adjust the upper thread tension.</li> <li>&gt; Check the thread feed from the thread spool.</li> </ul>
	Needle blunt or bent.	<ul style="list-style-type: none"> <li>&gt; Replace the needle, make sure that a new BERNINA quality needle is used.</li> </ul>
	Poor quality needle.	<ul style="list-style-type: none"> <li>&gt; Use a new BERNINA quality needle.</li> </ul>
	Poor quality thread.	<ul style="list-style-type: none"> <li>&gt; Use quality thread.</li> </ul>
	Incorrect needle/thread combination.	<ul style="list-style-type: none"> <li>&gt; Match the needle with the thread size.</li> </ul>
	Incorrectly threaded.	<ul style="list-style-type: none"> <li>&gt; Rethread.</li> </ul>
	Fabric was pulled.	<ul style="list-style-type: none"> <li>&gt; Feed the fabric evenly.</li> </ul>
<b>Uneven Stitch Formation</b>	Incorrect bobbin case is used.	<ul style="list-style-type: none"> <li>&gt; Use the supplied bobbin case marked with the triangle.</li> </ul>



Fault	Cause	Solution
<b>Skipped Stitches</b>	Incorrect needle.	> Use the needle system 130/705H.
	Needle blunt or bent.	> Replace the needle.
	Poor quality needle.	> Use a new BERNINA quality needle.
	The needle is incorrectly inserted.	> Insert the needle with the flat side to the back as far up as it will go into the needle holder and tighten the screw.
	Incorrect needle point.	> Match the needle point to the texture of the material.
<b>Faulty Stitching</b>	Thread remnants between the thread tension discs.	> Fold a piece of thin material and slide the folded edge (not the raw edges) between the thread tension discs.
	Incorrectly threaded.	> Rethread.
	Thread remnants below the bobbin case spring.	> Remove the thread remnants under the spring.
<b>Upper Thread Breaks</b>	Incorrect needle/thread combination.	> Match the needle with the thread size.
	Upper thread is too tight.	> Reduce the upper thread tension.
	Incorrectly threaded.	> Rethread.
	Poor quality thread.	> Use quality thread.
	The stitch plate or the hook tip is damaged.	> Contact your authorized BERNINA dealer to have the damages repaired. > Replace the stitch plate.
	The thread is caught in the area of the thread take-up lever.	> Remove the screw (1) on the headframe with the angular Torx Screwdriver. > Carefully pull the headframe forward at the bottom. > Flip the headframe upwards a bit and remove it. > Remove the thread remnants. > Attach the headframe and tighten the screw.
<b>Lower Thread Breaks</b>	The bobbin case is damaged.	> Replace the bobbin case.
	The stitch hole in the stitch plate is damaged.	> Contact your authorized BERNINA dealer to have the damages repaired. > Replace the stitch plate.
	Needle blunt or bent.	> Replace the needle.



Fault	Cause	Solution
<b>Needle Breaks</b>	The needle is incorrectly inserted.	> Insert the needle with the flat side to the back as far up as it will go into the needle holder and tighten the screw.
	Fabric was pulled.	> Feed the fabric evenly.
	Thick fabric has been pushed.	> Use a suitable presser foot, e. g. Jeans Foot #8, for thick fabric. > Use the height compensating tool when sewing over a thick seam.
	Knotted thread.	> Use quality thread.
<b>Display is Inactive</b>	Incorrect calibrating data.	> Recalibrate the display. (see page 60) > If calibration cannot be selected in the Setup Program, switch the machine on again while simultaneously pushing and holding the buttons «Needle Position Right/Left».
	The eco Mode is active.	> Tap «eco Mode».
<b>Stitch Width Not Adjustable</b>	The selected needle and stitch plate cannot be used in combination.	> Replace the needle. > Replace the stitch plate.
	The «Presser Foot Indicator/Presser Foot Selection» prevents the adjustment of the stitch width.	> Select the fitted presser foot.
<b>Speed Too Low</b>	Unfavorable room temperature.	> Place the machine in a warm room one hour before use.
	Settings in the Setup Program.	> Adjust the sewing speed in the Setup Program. > Adjust the slide.
<b>The Machine doesn't Start</b>	Unfavorable room temperature.	> Place the machine in a warm room one hour before use. > Connect the machine and switch it on.
	The machine is damaged.	> Contact your authorized BERNINA dealer.
<b>The Light of the Button "Start-/Stop" doesn't Light Up</b>	Light is defect.	> Contact your authorized BERNINA dealer.
<b>Neither the Sewing Light Nor the Light on the Freearm Lights Up</b>	Settings in the Setup Program.	> Activate it in the Setup Program.
	The sewing light is defect.	> Contact your authorized BERNINA dealer.
<b>Upper Thread Indicator Fails to Respond</b>	Settings in the Setup Program.	> Activate it in the Setup Program.
	The upper thread indicator is defect.	> Contact your authorized BERNINA dealer.

Fault	Cause	Solution
<b>Bobbin Thread Indicator doesn't React</b>	Settings in the Setup Program.	> Activate it in the Setup Program.
	The bobbin thread indicator is defect.	> Contact your authorized BERNINA dealer.
<b>Error during Firmware Update</b>	USB stick is not recognized.	> Use the BERNINA USB stick.
	The update process is blocked and the hourglass on the display is inactive.	> Remove the USB stick. > Switch off the machine. > Switch the machine on. > Follow the instruction on the display.
	Firmware update files are not found.	> Unzip the update data. > Store data for the firmware update directly on the data medium and not in a folder on the USB stick.
<b>BSR Presser Foot #42 not detected</b>	Lens is dirty.	> Clean the lens with a soft, slightly damp cloth.
	BSR cable not inserted correctly.	> Insert the BSR connector vertically until it can be felt to click into place.
<b>Beads and/or Bartacks are repeatedly not sewn properly</b>	The Buttonhole Foot with Slide #3A is not calibrated with the machine.	> Calibrate Buttonhole Foot with Slide #3A. (see page 61)
<b>The Automatic Needle Threader does not work reliably</b>	The automatic needle threader is dirty.	> Clean the needle threader. (see page 181)
<b>The Automatic Needle Threader does not thread the needle</b>	The needle selected in the needle selection cannot be threaded, e.g. twin needle.	> Single needle: Select the needle in the needle selection to match the fitted needle. > Double and triple needles: Thread the needles by hand.
<b>The laser dot is not visible or is at the wrong position</b>	The laser is concealed or deflected by the presser foot or the needle.	> Raise the needle. > Fit another presser foot. > lower the presser foot before the sewing start, e.g. with the knee lifter. > Contact your authorized BERNINA dealer.



## 19 Storage and Disposal

### 19.1 Storing the Machine

It is recommended to store the machine in the original packaging. If the machine is stored in a cold room, place it in a warm room one hour before use.

- > Switch the machine off and disconnect it from the power supply.
- > Don't store the machine outdoors.
- > Protect the machine against climatic influences.

### 19.2 Dispose of the Machine

- > Clean the machine.
- > Sort the components by their materials and dispose of them according to the local laws and regulations.

## 20 Technical Data

Designation	Value	Unit
Maximum Fabric Thickness	12.5 (0.49)	mm (in)
Maximum Speed	1000	Stitches per Minute
Foot Control	LV-1	
Needle System	130/705	
Measurements without the Spool Pin (W × H × D)	520 × 355 × 215 (20.47 × 13.98 × 8.46)	mm (in)
Measurements incl. Embroidery Module without Spool Pin (W × H × D)	950 × 355 × 630 37.40 × 13.98 × 24.80	mm (in)
Weight of the Machine	14 (30.86)	kg (lb)
Weight of the Embroidery Module	6.4 14.1	kg (lb)
Energy Consumption	140	W
Input Voltage	100 – 240 50 - 60	V Hz
WiFi Frequency Range	2.4	GHz
WiFi Protocol	802.11 b/g/n	
Protection Class (Electrical Engineering)	II	



## 21 Overview Stitch Patterns

### 21.1 Overview Stitch Patterns

#### Practical Stitches

1	2	3	4	5	6	7	8	9	10	11	12	13	14
15	16	17	18	19	20	21	22	23	24	25	26	27	29
31	32	33	34	35	36	37	38	39	40				

#### Buttonholes

51	52	53	54	55	56	57	58	59	60	61	62	63	64
65	66	67	68	69	70								

#### Decorative Stitches

##### Nature Stitches

101	102	103	104	105	106	107	108	109	110	111	112	113	114
115	116	117	118	119	122	123	124	125	126	127	128	129	130
131	132	134	136	137	138	139	140	141	142	143	144	145	146
147	148	150	152	153	154	155	156	159	160	161	165	166	167
168	169	170	171	172	173	174	175	176	177	178	179	180	181
182	183	184	185										

Nature Stitches with Sideways Motion

201	202	203	204	205	206	207	208	209	210	211	212	213	216
217	218	219	220	230	231	232	233	234	235	236	237	238	239
240	241	242	243	244	245	246	247	248	249	250	251	252	268
269													

Cross Stitches

301	302	303	304	305	306	307	308	309	311	313	314	316	318
319	320	321	322	323	324	325	326	327	328	329	330	331	332
333	334	335	336	337	338	339	371	372	373	374	375	376	377
378	379												

Satin Stitches

401	402	405	406	407	408	409	410	412	413	414	415	416	417
418	419	421	422	423	424	425	426	427	428	429	430	431	433
434	436	437	440	442	443	444	445	447	448	449	450	451	452
453	454	455	456	457	458	461	464	465	466	467	468	469	471

472 	473 
---------	---------

Satin Stitches with Sideways Motion

501 	503 	505 	506 	507 	508 	509 	510 	511 	512 	513 	514 	517 	518 
519 	520 	523 	524 	525 									

Geometric Stitches

601 	602 	603 	604 	605 	606 	607 	608 	609 	610 	611 	612 	613 	614 
615 	616 	618 	619 	620 	621 	622 	623 	624 	625 	626 	627 	628 	629 
630 	631 	632 	633 	634 	635 	636 	637 	639 	640 	641 	642 	643 	644 
645 	646 	647 	648 	649 	650 	651 	652 	653 	654 	655 	656 	657 	658 
660 	661 	662 	663 	664 	665 	666 	674 	675 	676 	677 	678 	679 	680 
682 	683 	684 	685 	686 	691 	693 	694 	695 					

White Embroidery

701 	702 	703 	704 	705 	706 	707 	708 	709 	710 	711 	712 	713 	714 
715 	716 	717 	721 	722 	723 	724 	725 	726 	727 	729 	730 	731 	732 
733 	734 	735 	736 	737 	738 	739 	740 	741 	742 	743 	744 	745 	746 

Overview Stitch Patterns

747 	748 	749 	750 	751 	752 	756 	757 	758 	759 	762 	764 	765 	766 
767 	768 	769 	770 	771 	772 	773 	774 	775 	776 	777 	778 	779 	780 
781 	782 	783 											

White Embroidery with Sideways Motion

801 	802 	803 	804 	805 	833 	834 	835 	840 	841 
---------	---------	---------	---------	---------	---------	---------	---------	---------	---------

Children Stitches

901 	902 	903 	904 	905 	906 	907 	908 	909 	910 	911 	912 	913 	914 
915 	916 	917 	918 	919 	920 	921 	922 	924 	926 	928 	929 	933 	934 
935 	937 	938 	939 	940 	944 	945 	946 	948 	949 	950 	952 	954 	955 
957 	958 	959 	960 	961 	962 								

Children Stitches with Sideways Motion

1001 	1002 	1003 	1004 	1005 	1006 	1007 	1008 	1014 	1015 
----------	----------	----------	----------	----------	----------	----------	----------	----------	----------

Filigree Stitches with Sideways Motion

1201 	1202 	1203 	1204 	1205 	1206 	1207 	1208 	1209 	1210 	1211 	1212 	1213 	1214 
1215 	1216 	1217 	1218 	1220 	1221 	1222 	1223 	1225 	1226 	1227 			

Tapering Stitches

1401	1402	1403	1404	1405	1406	1409	1411	1412	1413	1414	1415	1416	1417
1418	1419	1420	1422	1423	1424	1430	1431	1446	1447	1448	1450	1460	1462

Skyline Stitches (Special Stitches)

1501 SWISS	1502 Zürich	1503 ESPAÑA	1504 London	1505 AUSTRALIA	1506 AUSSIE	1507 Africa	1508 New Zealand	1509 TOKYO	1510 DELHI	1511 EGYPT	1512 Garden of Eden	1513 New York	1514 I LOVE YOU
1515 BERLIN	1516 Moscow	1517 Paris	1518 Glasgow	1519 Sydney	1520 ROMA	1521 Sydney	1522 Dutch	1524 Scandinavia	1525 NORWAY	1526 USA	1527 Brazil	1528 New York	1529 New York
1531 New York	1534 New York												

Quilt Stitches with Sideways Motion

1601	1602	1603	1604	1605	1606	1607	1608	1609	1610	1611	1612	1613	1614
1615	1616	1617	1618	1619	1620	1629	1630	1631	1632	1633	1634	1635	1636
1657	1658	1659	1660										

International

1701	1702	1703	1704	1705	1706	1707	1708	1709	1710	1711	1715	1716	1717
1718	1719	1720	1721	1722	1723	1729	1730	1731	1732	1733	1735	1736	

Seasons

2001	2002	2003	2004	2005	2006	2007	2008	2009	2015	2016	2017	2018	2019
------	------	------	------	------	------	------	------	------	------	------	------	------	------

## Overview Stitch Patterns

2020	2021	2022	2023

### Sport and Hobbies

2201	2202	2203	2204	2205	2206	2207	2209	2210	2211	2212	2213	2215	2216
2217	2218	2219	2220	2222	2227								

### Quilt Stitches

1301	1302	1303	1304	1305	1306	1307	1308	1309	1310	1311	1312	1313	1314
				9 / inch 2,4 / cm	8 / inch 3,2 / cm	10 / inch 4 / cm	irregular look						
1315	1316	1317	1318	1319	1320	1321	1322	1323	1324	1325	1326	1327	1329
1330	1331	1332	1333	1334	1335	1336	1337	1338	1339	1340	1341	1342	1343
1344	1345	1346	1363	1364	1365	1366	1367	1368	1369	1370	1371	1373	1374
1375	1376	1377	1378	1379	1380	1381	1382	1384	1385	1386	1387	1388	1389

## 21.2 Overview Embroidery Desings






### Editing the Embroidery Design

Let your creativity run free. A vast selection of embroidery designs is at your disposal on your machine.

After registering your machine, the supplied embroidery designs are available as downloads in an editable format at the BERNINA Customer Portal.















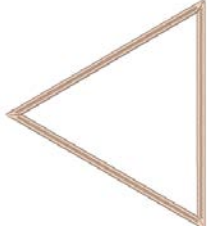









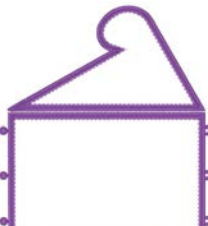




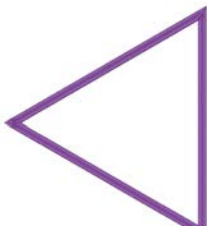














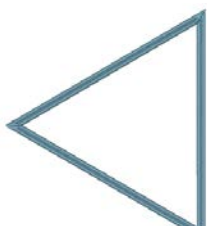




























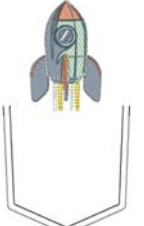
If you see one of the following pictograms below a number of the embroidery design, you can find additional information at <https://www.bernina.com/specialeffects>.

	Detached Point		PunchWork
	Basic CutWork		Couching
	Fringe Embroidery		Projects in the Hoop
	Appliqué		Puffy Fonts










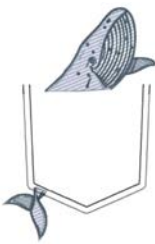






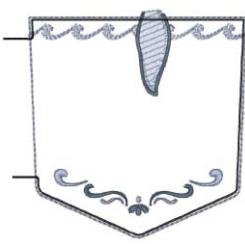






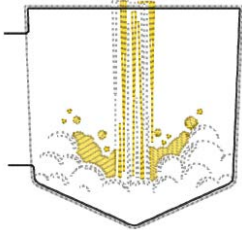



























































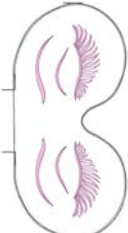
	CutWork		Quilting
	PaintWork		Trapunto
	CrystalWork		

## Projects

You can find the detailed embroidery instructions at <https://www.bernina.com/790PRO-designs>.


<b>12888-01</b>  110 x 125 mm 4.3 x 4.9 inch  10.220	<b>12888-02</b>  98 x 113 mm 3.9 x 4.4 inch  4.457
<ol style="list-style-type: none"> <li>1.  Isacord 40 2520</li> <li>2.  Isacord 40 2520</li> <li>3.  Isacord 40 2520</li> <li>4.  Isacord 40 2520</li> <li>5.  Isacord 40 0010</li> </ol> 	<ol style="list-style-type: none"> <li>1.  Isacord 40 2520</li> <li>2.  Isacord 40 2520</li> <li>3.  Isacord 40 2520</li> <li>4.  Isacord 40 2520</li> </ol> 
<b>12888-03</b>  150 x 165 mm 5.9 x 6.5 inch  14.152	<b>12888-04</b>  122 x 141 mm 4.8 x 5.6 inch  5.603
<ol style="list-style-type: none"> <li>1.  Isacord 40 2905</li> <li>2.  Isacord 40 2905</li> <li>3.  Isacord 40 2905</li> <li>4.  Isacord 40 2905</li> <li>5.  Isacord 40 0010</li> </ol> 	<ol style="list-style-type: none"> <li>1.  Isacord 40 2905</li> <li>2.  Isacord 40 2905</li> <li>3.  Isacord 40 2905</li> <li>4.  Isacord 40 2905</li> </ol> 
<b>12888-05</b>  125 x 190 mm 4.9 x 7.5 inch  13.411	<b>12888-06</b>  98 x 113 mm 3.9 x 4.4 inch  4.457
<ol style="list-style-type: none"> <li>1.  Isacord 40 4032</li> <li>2.  Isacord 40 4032</li> <li>3.  Isacord 40 4032</li> <li>4.  Isacord 40 4032</li> <li>5.  Isacord 40 0010</li> </ol> 	<ol style="list-style-type: none"> <li>1.  Isacord 40 4032</li> <li>2.  Isacord 40 4032</li> <li>3.  Isacord 40 4032</li> <li>4.  Isacord 40 4032</li> </ol> 
<b>51240-28</b>  76 x 130 mm 3 x 5.1 inch  6.028	<b>51240-32</b>  76 x 142 mm 3 x 5.6 inch  3.835
<ol style="list-style-type: none"> <li>1.  Isacord 40 1332</li> <li>2.  Isacord 40 0811</li> <li>3.  Isacord 40 3963</li> <li>4.  Isacord 40 3910</li> <li>5.  Isacord 40 3810</li> <li>6.  Isacord 40 0010</li> <li>7.  Isacord 40 0131</li> <li>8.  Isacord 40 1913</li> <li>9.  Isacord 40 1521</li> <li>10.  Isacord 40 2123</li> <li>11.  Isacord 40 1322</li> <li>12.  Isacord 40 0020</li> <li>13.  Isacord 40 0020</li> </ol> 	<ol style="list-style-type: none"> <li>1.  Isacord 40 0010</li> <li>2.  Isacord 40 0811</li> <li>3.  Isacord 40 5450</li> <li>4.  Isacord 40 4752</li> <li>5.  Isacord 40 1725</li> <li>6.  Isacord 40 0010</li> <li>7.  Isacord 40 3743</li> <li>8.  Isacord 40 1725</li> <li>9.  Isacord 40 0020</li> <li>10.  Isacord 40 0020</li> </ol> 


# Overview Stitch Patterns

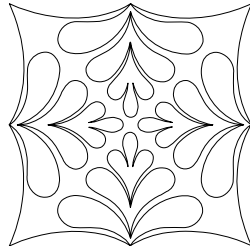
<b>51240-36</b>  92 x 141 mm 3.6 x 5.5 inch  5.338	<b>51240-35</b>  89 x 83 mm 3.5 x 3.3 inch  2.628
<ol style="list-style-type: none"> <li>1.  Isacord 40 3641</li> <li>2.  Isacord 40 3963</li> <li>3.  Isacord 40 3743</li> <li>4.  Isacord 40 0020</li> <li>5.  Isacord 40 0020</li> </ol> 	<ol style="list-style-type: none"> <li>1.  Isacord 40 0020</li> <li>2.  Isacord 40 3641</li> <li>3.  Isacord 40 3963</li> <li>4.  Isacord 40 3743</li> <li>5.  Isacord 40 0020</li> <li>6.  Isacord 40 0020</li> </ol> 
<b>51240-31</b>  87 x 83 mm 3.4 x 3.3 inch  3.327	<b>51240-27</b>  87 x 80 mm 3.4 x 3.2 inch  4.258
<ol style="list-style-type: none"> <li>1. Isacord 40 0010</li> <li>2. Isacord 40 0010</li> <li>3. Isacord 40 0010</li> <li>4.  Isacord 40 0811</li> <li>5.  Isacord 40 0020</li> </ol> 	<ol style="list-style-type: none"> <li>1.  Isacord 40 0630</li> <li>2.  Isacord 40 0630</li> <li>3.  Isacord 40 0630</li> <li>4.  Isacord 40 1332</li> <li>5.  Isacord 40 0811</li> <li>6.  Isacord 40 1322</li> <li>7.  Isacord 40 0020</li> </ol> 
<b>51298-02</b>  99 x 129 mm 3.9 x 5.1 inch  9.279	<b>51298-03</b>  83 x 82 mm 3.3 x 3.2 inch  5.081
<ol style="list-style-type: none"> <li>1.  Isacord 40 0630</li> <li>2.  Isacord 40 0630</li> <li>3.  Isacord 40 0630</li> <li>4.  Isacord 40 6051</li> </ol> 	<ol style="list-style-type: none"> <li>1.  Isacord 40 0870</li> <li>2.  Isacord 40 0870</li> <li>3.  Isacord 40 0870</li> <li>4.  Isacord 40 1565</li> </ol> 
<b>51298-04</b>  38 x 230 mm 1.5 x 9.1 inch  17.556	<b>51298-05</b>  83 x 82 mm 3.3 x 3.2 inch  4.439
<ol style="list-style-type: none"> <li>1.  Isacord 40 0630</li> <li>2.  Isacord 40 0630</li> <li>3.  Isacord 40 0630</li> <li>4.  Isacord 40 1220</li> <li>5.  Isacord 40 1565</li> <li>6.  Isacord 40 0870</li> </ol> 	<ol style="list-style-type: none"> <li>1.  Isacord 40 1565</li> <li>2.  Isacord 40 1565</li> <li>3.  Isacord 40 1565</li> </ol> 
<b>51298-06</b>  110 x 199 mm 4.3 x 7.8 inch  34.440	<b>51298-01</b>  88 x 129 mm 3.4 x 5.1 inch  9.306
<ol style="list-style-type: none"> <li>1.  Isacord 40 0630</li> <li>2.  Isacord 40 1220</li> <li>3.  Isacord 40 1860</li> </ol> 	<ol style="list-style-type: none"> <li>1.  Isacord 40 6051</li> <li>2.  Isacord 40 6051</li> <li>3.  Isacord 40 6051</li> </ol> 
<b>12751-03</b>  100 x 192 mm 3.9 x 7.6 inch  5.132	
<ol style="list-style-type: none"> <li>1.  Isacord 40 2550</li> <li>2.  Isacord 40 2550</li> <li>3.  Isacord 40 2550</li> <li>4.  Isacord 40 2550</li> <li>5.  Isacord 40 2550</li> <li>6.  Isacord 40 2550</li> <li>7.  Isacord 40 2550</li> <li>8.  Isacord 40 2550</li> </ol> 	



## Quilt Designs

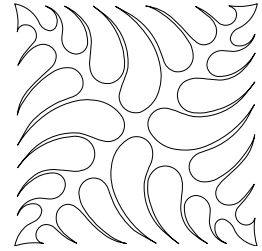
 80202-01


1.  Isacord 40 0020




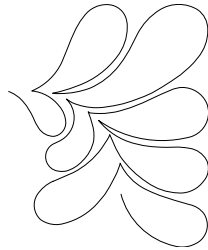
 80202-02

1.  Isacord 40 0020



 80202-03


1.  Isacord 40 0020




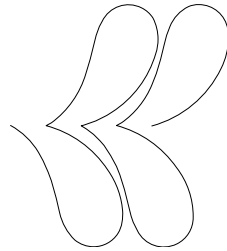
 80202-04


1.  Isacord 40 0020



 80202-05


1.  Isacord 40 0020




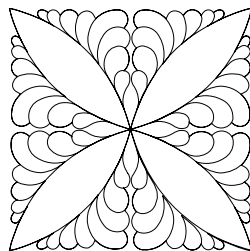
 80202-06


1.  Isacord 40 0020



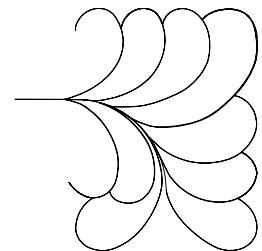
 80257-01


1.  Isacord 40 0020




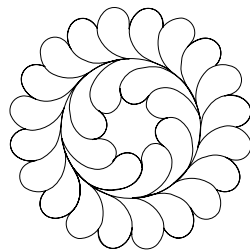
 80257-02


1.  Isacord 40 0020



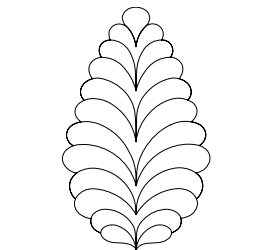
 80257-03


1.  Isacord 40 0020



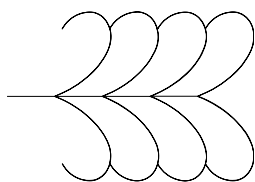
 80257-04

1.  Isacord 40 0020



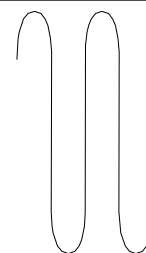
 80257-05

1.  Isacord 40 0020



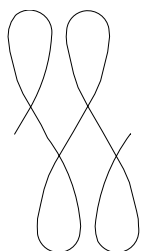
 Basics\_01

1.  Isacord 40 0020



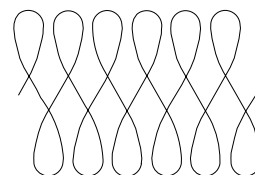
 Basics\_02

1.  Isacord 40 0020



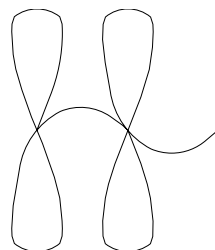
 Basics\_03


1.  Isacord 40 0020



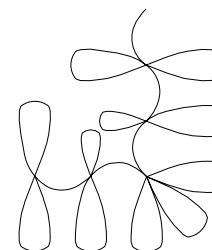
 Basics\_04


1.  Isacord 40 0020



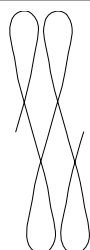
 Basics\_04\_corner


1.  Isacord 40 0020



 Basics\_05


1.  Isacord 40 0020



 12380-04q


1.  Isacord 40 0020



 12380-08q


1.  Isacord 40 0020



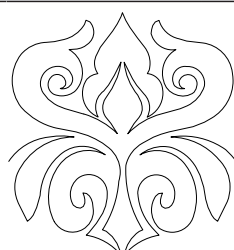
 12380-09q


1.  Isacord 40 0020



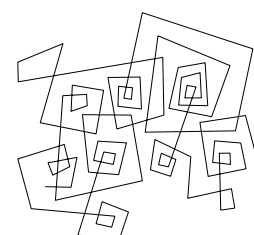
 32196-01


1.  Isacord 40 0020



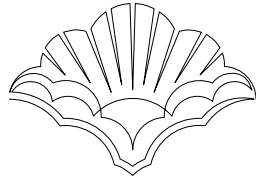
 32196-02


1.  Isacord 40 0020



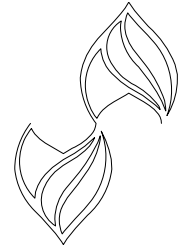
 32196-03


1. ■ Isacord 40 0020



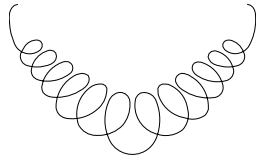
 32196-04


1. ■ Isacord 40 0020



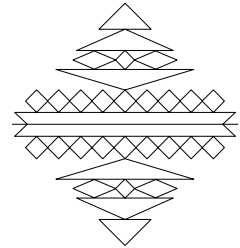
 32196-05


1. ■ Isacord 40 0020



 32196-06


1. ■ Isacord 40 0020



 32196-07


1. ■ Isacord 40 0020



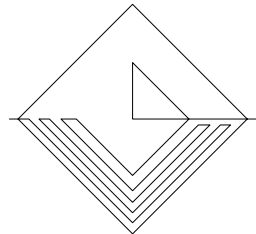
 32196-08


1. ■ Isacord 40 0020



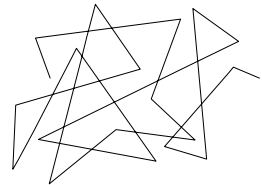
 32196-09


1. ■ Isacord 40 0020



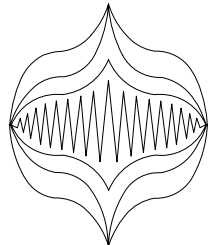
 32196-10


1. ■ Isacord 40 0020



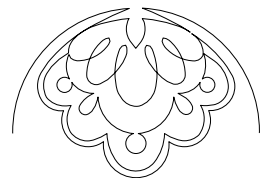
 32196-11


1. ■ Isacord 40 0020



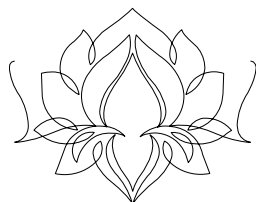
 32196-12


1. ■ Isacord 40 0020



 32196-13


1. ■ Isacord 40 0020



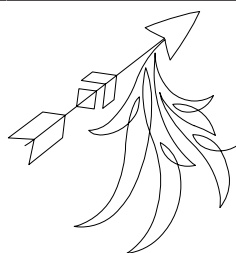
 32196-14


1. ■ Isacord 40 0020



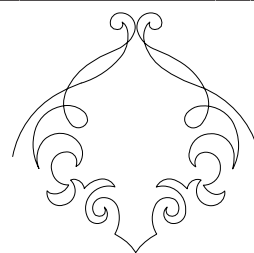
 32196-15


1. ■ Isacord 40 0020



 32196-16


1. ■ Isacord 40 0020



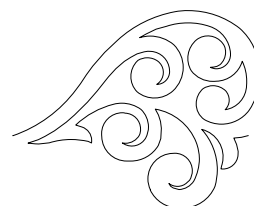
 32196-17


1. ■ Isacord 40 0020



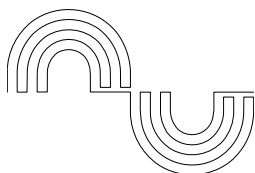
 32196-18


1. ■ Isacord 40 0020



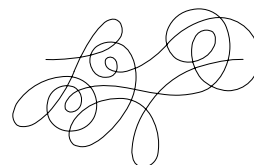
 32196-19


1. ■ Isacord 40 0020



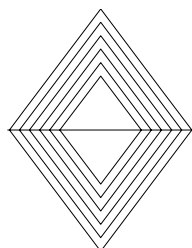
 32196-20


1. ■ Isacord 40 0020



 32196-21


1. ■ Isacord 40 0020



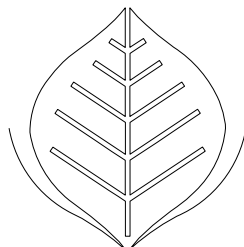
 32196-22


1. ■ Isacord 40 0020



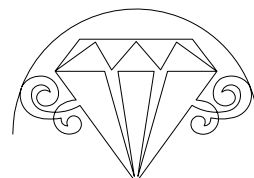
 32196-23


1. ■ Isacord 40 0020



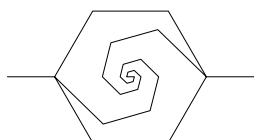
 32196-24


1. ■ Isacord 40 0020



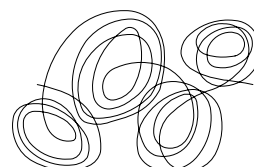
 32196-25

1. ■ Isacord 40 0020



 32196-26

1. ■ Isacord 40 0020



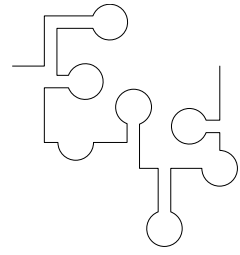
**32196-27**

1. ■ Isacord 40 0020



**32196-28**

1. ■ Isacord 40 0020



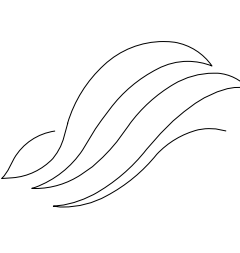
**32196-29**

1. ■ Isacord 40 0020



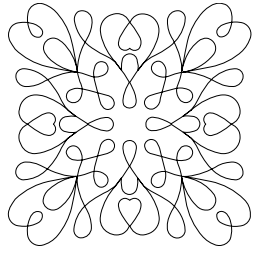
**32196-30**

1. ■ Isacord 40 0020



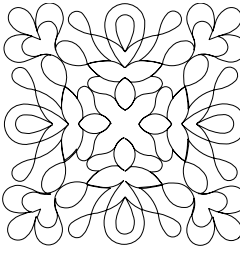
**BD285q**

1. ■ Isacord 40 0020



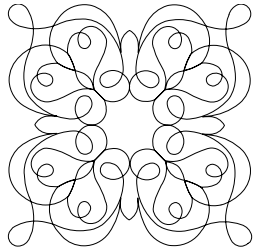
**BD288q**

1. ■ Isacord 40 0020



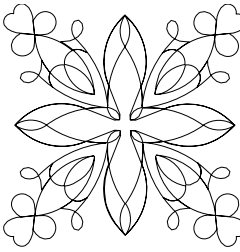
**BD289q**

1. ■ Isacord 40 0020



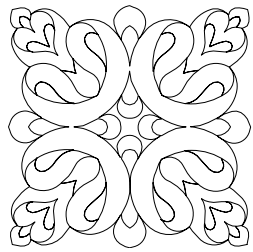
**BD292q**

1. ■ Isacord 40 0020



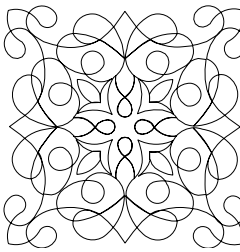
**BD299q**

1. ■ Isacord 40 0020



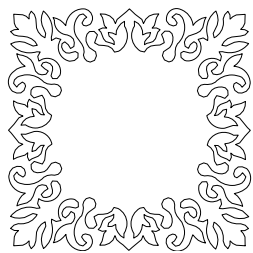
**BD308q**

1. ■ Isacord 40 0020



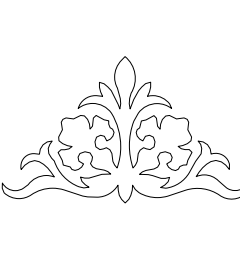
**BD394**

1. ■ Isacord 40 0020



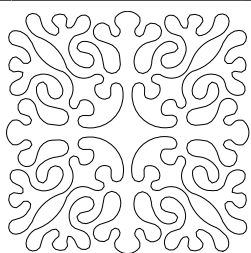
**BD412**

1. ■ Isacord 40 0020



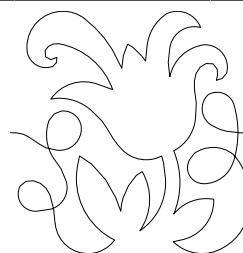
 **BD413**

1. ■ Isacord 40 0020



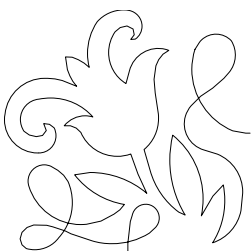
 **BD513**

1. ■ Isacord 40 0020



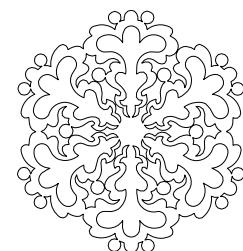
 **BD514**

1. ■ Isacord 40 0020



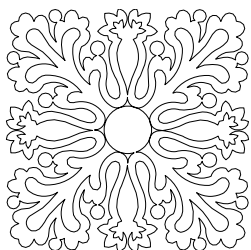
 **BD553**

1. ■ Isacord 40 0020



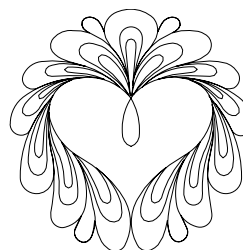
 **BD554**

1. ■ Isacord 40 0020



 **BD567**

1. ■ Isacord 40 0020



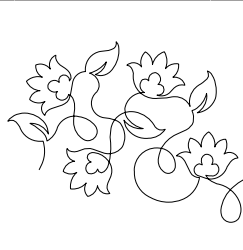
 **BD659**

1. ■ Isacord 40 0020



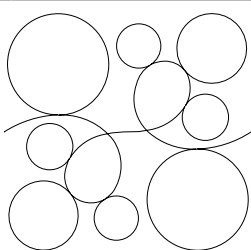
 **BD665**


1. ■ Isacord 40 0020



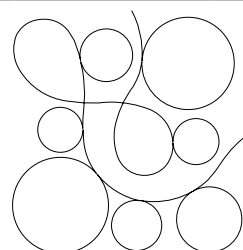
 **BD800**

1. ■ Isacord 40 0020



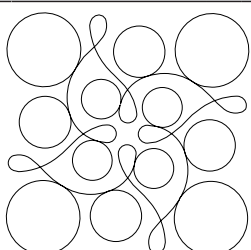
 **BD801**

1. ■ Isacord 40 0020



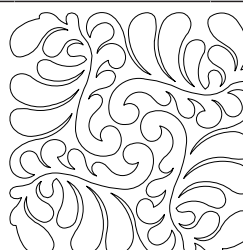
 **BD804**

1. ■ Isacord 40 0020



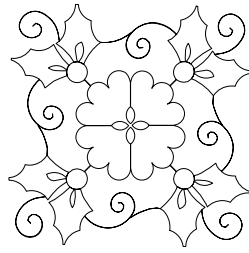
 **BD837**

1. ■ Isacord 40 0020



**HE959**

1. Isacord 40 0020



**Embellishment**

**12804-04**

203 x 213 mm  
8 x 8.4 inch 37.019

1. Isacord 40 2300
2. Isacord 40 1551
3. Isacord 40 0506
4. Isacord 40 1904
5. Isacord 40 2220



**12746-11**

110 x 110 mm  
4.3 x 4.3 inch 21.560

1. Isacord 40 2762
2. Isacord 40 0761
3. Isacord 40 2764
4. Isacord 40 2153



**12627-22**

67 x 173 mm  
2.6 x 6.8 inch 9.172

1. Isacord 40 2320



**12633-09**

120 x 120 mm  
4.7 x 4.7 inch 16.361

1. Isacord 40 0015



**12655-13**

110 x 126 mm  
4.3 x 5 inch 10.045

1. Isacord 40 1055



**12713-03**

134 x 132 mm  
5.3 x 5.2 inch 26.164

1. Isacord 40 5832
2. Isacord 40 5450
3. Isacord 40 5722
4. Isacord 40 1321
5. Isacord 40 1911
6. Isacord 40 4174
7. Isacord 40 2530
8. Isacord 40 2320
9. Isacord 40 1730
10. Isacord 40 1911
11. Isacord 40 0800
12. Isacord 40 1321
13. Isacord 40 0015
14. Isacord 40 4174



**51202-14**

82 x 139 mm  
3.2 x 5.5 inch 21.603

1. Isacord 40 0622
2. Isacord 40 2153
3. Isacord 40 0310
4. Isacord 40 5555
5. Isacord 40 5513
6. Isacord 40 6043
7. Isacord 40 2153







































































**12791-04L**































































203 x 207 mm  
8 x 8.1 inch 15.540

1. Isacord 40 4174
2. Isacord 40 4174
3. Isacord 40 1900
4. Isacord 40 4174
5. Isacord 40 0310
6. Isacord 40 4174



<p><b>12812-01L</b>  197 x 222 mm 7.7 x 8.7 inch  31.258</p>	<p><b>12812-02L</b>  197 x 176 mm 7.8 x 6.9 inch  29.132</p>
<p>1.  Isacord 40 0020</p> 	<p>1.  Isacord 40 0020</p> 
<p><b>12812-08M</b>  146 x 199 mm 5.7 x 7.8 inch  23.815</p>	<p><b>12812-03L</b>  197 x 205 mm 7.8 x 8.1 inch  38.896</p>
<p>1.  Isacord 40 0020</p> 	<p>1.  Isacord 40 0020</p> 
<p><b>12843-04</b>  126 x 199 mm 5 x 7.8 inch  16.487</p>	<p><b>12843-08</b>  129 x 172 mm 5.1 x 6.8 inch  13.522</p>
<p>1.  Isacord 40 0520 2.  Isacord 40 0310 3.  Isacord 40 5510 4.  Isacord 40 5740 5.  Isacord 40 5610 6.  Isacord 40 0311 7.  Isacord 40 0010 8.  Isacord 40 5510 9.  Isacord 40 0311</p> 	<p>1.  Isacord 40 0311 2.  Isacord 40 0520 3.  Isacord 40 0310 4.  Isacord 40 0010 5.  Isacord 40 5510 6.  Isacord 40 0520 7.  Isacord 40 5610 8.  Isacord 40 5740 9.  Isacord 40 0310</p> 
<p><b>12843-10</b>  87 x 163 mm 3.4 x 6.4 inch  12.094</p>	<p><b>12854-01</b>  208 x 280 mm 8.2 x 11 inch  17.641</p>
<p>1.  Isacord 40 0311 2.  Isacord 40 0310 3.  Isacord 40 0520 4.  Isacord 40 5740 5.  Isacord 40 5610 6.  Isacord 40 5510 7.  Isacord 40 0010 8.  Isacord 40 0310</p> 	<p>1.  Isacord 40 0015</p> 
<p><b>12854-02</b>  137 x 298 mm 5.4 x 11.8 inch  11.045</p>	<p><b>12919-01</b>  84 x 154 mm 3.3 x 6.1 inch  5.864</p>
<p>1.  Isacord 40 0015</p> 	<p>1.  Isacord 40 5210 2.  Isacord 40 0934 3.  Isacord 40 3962 4.  Isacord 40 2560 5.  Isacord 40 2732 6.  Isacord 40 1055</p> 



<p><b>12919-02</b>  73 x 152 mm 2.9 x 6 inch  6.442</p>	<p><b>21021-10</b>  117 x 148 mm 4.6 x 5.8 inch  14.469</p>
<p>1.  Isacord 40 2560 2.  Isacord 40 2732 3.  Isacord 40 1220 4.  Isacord 40 0934 5.  Isacord 40 1055 6.  Isacord 40 3962 7.  Isacord 40 3820</p> 	<p>1.  Isacord 40 1252 2.  Isacord 40 1161 3.  Isacord 40 1565</p> 
<p><b>21021-14</b>  122 x 122 mm 4.8 x 4.8 inch  18.063</p>	<p><b>12627-05</b>  93 x 100 mm 3.7 x 3.9 inch  8.679</p>
<p>1.  Isacord 40 1252 2.  Isacord 40 1161 3.  Isacord 40 1565</p> 	<p>1.  Isacord 40 5230</p> 
<p><b>51278-01</b>  116 x 147 mm 4.6 x 5.8 inch  14.604</p>	<p><b>51278-06</b>  170 x 117 mm 6.7 x 4.6 inch  15.393</p>
<p>1.  Isacord 40 1260 2.  Isacord 40 0731</p> 	<p>1.  Isacord 40 1260 2.  Isacord 40 0731</p> 
<p><b>51278-08</b>  82 x 165 mm 3.2 x 6.5 inch  4.893</p>	<p><b>51278-09</b>  110 x 128 mm 4.3 x 5 inch  7.310</p>
<p>1.  Isacord 40 0731 2.  Isacord 40 1260</p> 	<p>1.  Isacord 40 1260 2.  Isacord 40 0731</p> 
<p><b>51278-10</b>  89 x 228 mm 3.5 x 9 inch  6.998</p>	<p><b>51289-03</b>  146 x 130 mm 5.7 x 5.1 inch  13.672</p>
<p>1.  Isacord 40 0731 2.  Isacord 40 1260</p> 	<p>1.  Isacord 40 4740 2.  Isacord 40 0010 3.  Isacord 40 4410 4.  Isacord 40 4610 5.  Isacord 40 4643 6.  Isacord 40 4410 7.  Isacord 40 4610 8.  Isacord 40 4740 9.  Isacord 40 5643 10.  Isacord 40 5510 11.  Isacord 40 0010 12.  Isacord 40 0622</p> 

**12458-01** 32 x 174 mm  
1.3 x 6.9 inch 798

1. Isacord 40 2900



**80090-06** 84 x 37 mm  
3.3 x 1.4 inch 3.766

1. Applique 1
2. Applique 2
3. Isacord 40 4103



**80090-07** 128 x 36 mm  
5 x 1.4 inch 5.450

1. Applique 1
2. Applique 2
3. Isacord 40 5440



**Fq520\_48** 257 x 212 mm  
10.1 x 8.4 inch 15.274

1. YLI variations 8010
2. YLI variations 8004
3. YLI variations 8023
4. Isacord 40 9805
5. Isacord 40 9405
6. YLI variations 8023
7. YLI variations 8006
8. YLI variations 8019
9. Isacord 40 9912
10. Isacord 40 9918
11. YLI variations 8020
12. YLI variations 8006
13. Isacord 40 9916
14. Isacord 40 9605
15. YLI variations 8008
16. YLI variations 8009
17. Isacord 40 9914
18. Isacord 40 9405
19. Isacord 40 9916
20. Isacord 40 9302
21. Isacord 40 9805
22. YLI variations 8019
23. Isacord 40 9405
24. YLI variations 8020
25. Isacord 40 9605
26. YLI variations 8009
27. YLI variations 8021
28. YLI variations 8014



**Fq505\_48** 105 x 100 mm  
4.1 x 3.9 inch 4.618

1. Isacord 40 9405
2. Isacord 40 9916
3. Isacord 40 9302
4. Isacord 40 9805
5. YLI variations 8019
6. Isacord 40 9405
7. YLI variations 8020
8. Isacord 40 9605
9. YLI variations 8009
10. YLI variations 8021



**Fq506\_48** 154 x 87 mm  
6.1 x 3.4 inch 3.796

1. Isacord 40 9405
2. YLI variations 8020
3. Isacord 40 9805
4. YLI variations 8006
5. YLI variations 8008
6. YLI variations 8020



**Fq518\_48** 90 x 114 mm  
3.5 x 4.5 inch 4.269

1. YLI variations 8006
2. Isacord 40 9916
3. Isacord 40 9605
4. YLI variations 8008
5. YLI variations 8014
6. YLI variations 8009
7. Isacord 40 9914



**51204-15** 28 x 172 mm  
1.1 x 6.8 inch 5.304

1. Isacord 40 5510
2. Isacord 40 0703
3. Isacord 40 3713
4. Isacord 40 1102
5. Isacord 40 3210
6. Isacord 40 1805
7. Isacord 40 2723



**51209-09** 68 x 162 mm  
2.7 x 6.4 inch 14.542

1. Isacord 40 0020
2. Isacord 40 4410



**51209-08** 50 x 163 mm  
2 x 6.4 inch 15.255

1. Isacord 40 3030
2. Isacord 40 2920
3. Isacord 40 0020



**51202-08** 75 x 165 mm  
2.9 x 6.5 inch 7.518

1. Isacord 40 2152
2. Isacord 40 1921



## Flowers

**51227-08** 124 x 136 mm  
4.9 x 5.4 inch 26.077

1. Isacord 40 4430
2. Isacord 40 0010
3. Isacord 40 4610
4. Isacord 40 4515
5. Isacord 40 0702
6. Isacord 40 1521
7. Isacord 40 1840
8. Isacord 40 1860
9. Isacord 40 4174
10. Isacord 40 1704
11. Isacord 40 1521
12. Isacord 40 0010
13. Isacord 40 1755
14. Isacord 40 4174



**51227-10** 90 x 136 mm  
3.5 x 5.4 inch 20.095

1. Isacord 40 4515
2. Isacord 40 0702
3. Isacord 40 4610
4. Isacord 40 0010
5. Isacord 40 1840
6. Isacord 40 1860
7. Isacord 40 4531
8. Isacord 40 4515
9. Isacord 40 1521
10. Isacord 40 1840
11. Isacord 40 4174
12. Isacord 40 0010
13. Isacord 40 1840



**Fq561\_48** 185 x 243 mm  
7.3 x 9.6 inch 18.778

1. Isacord 40 0552
2. Isacord 40 6051
3. Isacord 40 5833
4. Isacord 40 5934
5. Isacord 40 5822
6. Isacord 40 5833
7. Isacord 40 5650
8. Isacord 40 3652
9. Isacord 40 3641
10. Isacord 40 3620
11. Isacord 40 0970
12. Isacord 40 1805
13. Isacord 40 2123
14. Isacord 40 1913



**12879-07L** 155 x 151 mm  
6.1 x 5.9 inch 5.437

1. Isacord 40 5740
2. Isacord 40 5440
3. Isacord 40 5210



**Nb826\_48** 135 x 133 mm  
5.3 x 5.2 inch 11.154

1. Isacord 40 9971
2. Isacord 40 9978
3. Isacord 40 9973
4. Isacord 40 1972



**Fs327\_48** 125 x 123 mm  
4.9 x 4.8 inch 10.514

1. Isacord 40 0862



**12914-01** 117 x 155 mm  
4.6 x 6.1 inch 19.835

1. Isacord 40 2600
2. Isacord 40 2241
3. Isacord 40 2944
4. Isacord 40 1342
5. Isacord 40 5643
6. Isacord 40 5912
7. Isacord 40 0465




























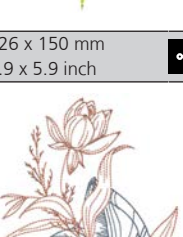







































**12914-02** 112 x 154 mm  
4.4 x 6.1 inch 16.778

1. Isacord 40 5643
2. Isacord 40 5722
3. Isacord 40 5912
4. Isacord 40 0465




Overview Stitch Patterns

<b>12914-03</b>  113 x 153 mm 4.4 x 6 inch  13.250	<b>12914-06</b>  110 x 151 mm 4.3 x 5.9 inch  15.331
<ol style="list-style-type: none"> <li>1.  Isacord 40 5643</li> <li>2.  Isacord 40 5722</li> <li>3.  Isacord 40 5912</li> <li>4.  Isacord 40 0853</li> <li>5.  Isacord 40 0465</li> </ol> 	<ol style="list-style-type: none"> <li>1.  Isacord 40 5722</li> <li>2.  Isacord 40 5912</li> <li>3.  Isacord 40 0465</li> </ol> 
<b>12914-07</b>  122 x 153 mm 4.8 x 6 inch  11.873	<b>12914-08</b>  106 x 159 mm 4.2 x 6.3 inch  16.390
<ol style="list-style-type: none"> <li>1.  Isacord 40 5643</li> <li>2.  Isacord 40 0853</li> <li>3.  Isacord 40 5912</li> <li>4.  Isacord 40 0465</li> </ol> 	<ol style="list-style-type: none"> <li>1.  Isacord 40 5912</li> <li>2.  Isacord 40 5643</li> <li>3.  Isacord 40 5722</li> <li>4.  Isacord 40 0465</li> </ol> 
<b>12919-04</b>  82 x 154 mm 3.2 x 6.1 inch  6.068	<b>51259-07</b>  126 x 150 mm 4.9 x 5.9 inch  7.750
<ol style="list-style-type: none"> <li>1.  Isacord 40 5210</li> <li>2.  Isacord 40 5220</li> <li>3.  Isacord 40 3820</li> <li>4.  Isacord 40 1362</li> <li>5.  Isacord 40 1220</li> <li>6.  Isacord 40 0934</li> </ol> 	<ol style="list-style-type: none"> <li>1.  Isacord 40 3743</li> <li>2.  Isacord 40 1600</li> </ol> 
<b>51285-08</b>  124 x 135 mm 4.9 x 5.3 inch  10.513	<b>Fq986_48</b>  139 x 145 mm 5.5 x 5.7 inch  23.426
<ol style="list-style-type: none"> <li>1.  Isacord 40 0152</li> <li>2.  Isacord 40 2650</li> <li>3.  Isacord 40 2721</li> <li>4.  Isacord 40 0020</li> <li>5.  Isacord 40 0020</li> </ol> 	<ol style="list-style-type: none"> <li>1.  Isacord 40 5650</li> <li>2.  Isacord 40 5833</li> <li>3.  Isacord 40 0352</li> <li>4.  Isacord 40 5934</li> <li>5.  Isacord 40 0465</li> <li>6.  Isacord 40 5822</li> <li>7.  Isacord 40 0015</li> <li>8.  Isacord 40 0781</li> <li>9.  Isacord 40 0170</li> <li>10.  Isacord 40 0731</li> <li>11.  Isacord 40 0640</li> <li>12.  Isacord 40 6133</li> </ol> 
<b>Fs316_48</b>  124 x 167 mm 4.9 x 6.6 inch  9.758	<b>Oc86020</b>  65 x 82 mm 2.6 x 3.2 inch  2.462
<ol style="list-style-type: none"> <li>1.  Isacord 40 3853</li> </ol>	<ol style="list-style-type: none"> <li>1.  Isacord 40 5610</li> <li>2.  Isacord 40 0504</li> <li>3.  Isacord 40 0922</li> <li>4.  Isacord 40 1840</li> <li>5.  Isacord 40 2363</li> <li>6.  Isacord 40 0520</li> <li>7.  Isacord 40 1123</li> </ol>


**12417-08** 104 x 160 mm  
4.1 x 6.3 inch 13.421

1. Isacord 40 0442
2. Isacord 40 0721
3. Isacord 40 0532
4. Isacord 40 0345
5. Isacord 40 1521
6. Isacord 40 0811
7. Isacord 40 1010
8. Isacord 40 1311




**12505-03** 108 x 162 mm  
4.3 x 6.4 inch 8.606

1. Isacord 40 0442
2. Isacord 40 5822
3. Isacord 40 5822
4. Isacord 40 6031
5. Isacord 40 5633
6. Isacord 40 2810
7. Isacord 40 2530
8. Isacord 40 2530
9. Isacord 40 2155
10. Isacord 40 0811
11. Isacord 40 0811
12. Isacord 40 2830
13. Isacord 40 2830
14. Isacord 40 2504
15. Isacord 40 4103
16. Isacord 40 0311
17. Isacord 40 0931
18. Isacord 40 0020




**12505-11** 104 x 174 mm  
4.1 x 6.9 inch 11.419

1. Isacord 40 0442
2. Isacord 40 5822
3. Isacord 40 5822
4. Isacord 40 6031
5. Isacord 40 5633
6. Isacord 40 2810
7. Isacord 40 2810
8. Isacord 40 0811
9. Isacord 40 0811
10. Isacord 40 1800
11. Isacord 40 1800
12. Isacord 40 0504
13. Isacord 40 0931
14. Isacord 40 2900
15. Isacord 40 2530
16. Isacord 40 1912
17. Isacord 40 1543
18. Isacord 40 0020




**12505-04** 124 x 176 mm  
4.9 x 6.9 inch 11.861

1. Isacord 40 3840
2. Isacord 40 3840
3. Isacord 40 3815
4. Isacord 40 0311
5. Isacord 40 5822
6. Isacord 40 5822
7. Isacord 40 6031
8. Isacord 40 5633
9. Isacord 40 0811
10. Isacord 40 0811
11. Isacord 40 2530
12. Isacord 40 2530
13. Isacord 40 2300
14. Isacord 40 2155
15. Isacord 40 0931
16. Isacord 40 0504
17. Isacord 40 0020
18. Isacord 40 0442




**12505-10** 102 x 134 mm  
4 x 5.3 inch 5.685

1. Isacord 40 4103
2. Isacord 40 0442
3. Isacord 40 5822
4. Isacord 40 5822
5. Isacord 40 6031
6. Isacord 40 5633
7. Isacord 40 1800
8. Isacord 40 1800
9. Isacord 40 2504
10. Isacord 40 0504
11. Isacord 40 0020




**Fs332\_48** 95 x 174 mm  
3.8 x 6.8 inch 12.081

1. Isacord 40 1725




**Fs337\_48** 69 x 136 mm  
2.7 x 5.4 inch 7.998























1. Isacord 40 1730















































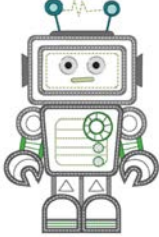
**51202-11** 64 x 75 mm  
2.5 x 3 inch 7.224



1. Isacord 40 5770
2. Isacord 40 5822
3. Isacord 40 1911
4. Isacord 40 1921
5. Isacord 40 1430
6. Isacord 40 1532
7. Isacord 40 1362
8. Isacord 40 2153
9. Isacord 40 2152
10. Isacord 40 2155
11. Isacord 40 2171
12. Isacord 40 0010
13. Isacord 40 0622







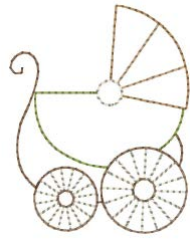
<b>51202-12</b>  83 x 46 mm 3.3 x 1.8 inch  5.388	<b>12852-01</b>  193 x 150 mm 7.6 x 5.9 inch  17.004
<ol style="list-style-type: none"> <li>1.  Isacord 40 5770</li> <li>2.  Isacord 40 5822</li> <li>3.  Isacord 40 1911</li> <li>4.  Isacord 40 2155</li> <li>5.  Isacord 40 2152</li> <li>6.  Isacord 40 2171</li> <li>7.  Isacord 40 2153</li> <li>8.  Isacord 40 1921</li> <li>9.  Isacord 40 0010</li> <li>10.  Isacord 40 0622</li> </ol> 	<ol style="list-style-type: none"> <li>1. Isacord 40 0010</li> </ol> 
<b>12852-07</b>  122 x 126 mm 4.8 x 4.9 inch  10.996	<b>12852-15</b>  86 x 108 mm 3.4 x 4.3 inch  6.566
<ol style="list-style-type: none"> <li>1. Isacord 40 0010</li> </ol> 	<ol style="list-style-type: none"> <li>1. Isacord 40 0010</li> </ol> 

## Children








 <b>12662-08</b>  105 x 109 mm 4.1 x 4.3 inch  12.928	<b>12436-29</b>  100 x 37 mm 3.9 x 1.4 inch  2.464
<ol style="list-style-type: none"> <li>1.  Isacord 40 1032</li> <li>2.  Isacord 40 1032</li> <li>3.  Isacord 40 1032</li> <li>4.  Isacord 40 1010</li> <li>5.  Isacord 40 0015</li> <li>6.  Isacord 40 5822</li> <li>7.  Isacord 40 4220</li> <li>8.  Isacord 40 4531</li> <li>9.  Isacord 40 1055</li> <li>10.  Isacord 40 0576</li> </ol> 	<ol style="list-style-type: none"> <li>1.  YLI variations 8016</li> <li>2.  YLI variations 8015</li> <li>3.  Yenmet 7030</li> </ol> 
<b>12441-37</b>  116 x 103 mm 4.6 x 4 inch  4.741	<b>12590-04</b>  104 x 158 mm 4.1 x 6.2 inch  24.036
<ol style="list-style-type: none"> <li>1.  Isacord 40 1900</li> </ol> 	<ol style="list-style-type: none"> <li>1.  Isacord 40 5740</li> <li>2.  Isacord 40 5740</li> <li>3.  Isacord 40 5740</li> <li>4.  Isacord 40 5740</li> <li>5.  Isacord 40 5740</li> <li>6.  Isacord 40 5740</li> <li>7.  Isacord 40 5740</li> <li>8.  Isacord 40 5740</li> <li>9.  Isacord 40 5740</li> <li>10.  Isacord 40 0015</li> <li>11.  Isacord 40 0020</li> <li>12.  Isacord 40 4230</li> <li>13.  Isacord 40 4116</li> <li>14.  Isacord 40 5510</li> <li>15.  Isacord 40 0132</li> <li>16.  Isacord 40 0112</li> <li>17.  Isacord 40 0132</li> <li>18.  Isacord 40 0015</li> </ol> 

**12401-16**  62 x 80 mm  
2.5 x 3.1 inch  1.274



1.  Isacord 40 1346
2.  Isacord 40 1342
3.  Isacord 40 0170
4.  Isacord 40 5934











**51237-06**  39 x 139 mm  
1.5 x 5.5 inch  8.619

1.  Isacord 40 1703
2.  Isacord 40 1010
3.  Isacord 40 1030
4.  Isacord 40 4620
5.  Isacord 40 0945
6.  Isacord 40 1565
7.  Isacord 40 0576












**51267-07**  99 x 144 mm  
3.9 x 5.7 inch  18.599

1.  Isacord 40 4250
2.  Isacord 40 4610
3.  Isacord 40 1060
4.  Isacord 40 1030
5.  Isacord 40 1310
6.  Isacord 40 2155
7.  Isacord 40 1753
8.  Isacord 40 4133




























**51272-07**  117 x 147 mm  
4.6 x 5.8 inch  21.530

1.  Isacord 40 2153
2.  Isacord 40 4250
3.  Isacord 40 3750
4.  Isacord 40 3971
5.  Isacord 40 0970
6.  Isacord 40 0184
7.  Isacord 40 1760
8.  Isacord 40 4174
9.  Isacord 40 2153








 **51211-14**  82 x 169 mm  
3.2 x 6.7 inch  12.945

1.  Isacord 40 1141
2.  Isacord 40 1141
3.  Isacord 40 1141
4.  Isacord 40 1141
5.  Isacord 40 1141
6.  Isacord 40 1141
7.  Isacord 40 1141
8.  Isacord 40 1141
9.  Isacord 40 1141
10.  Isacord 40 2123
11.  Isacord 40 3810
12.  Isacord 40 3630
13.  Isacord 40 3732
14.  Isacord 40 4074
15.  Isacord 40 1972
16.  Isacord 40 0020
17.  Isacord 40 0184
18.  Isacord 40 2123
19.  Isacord 40 0722
20.  Isacord 40 0020
21.  Isacord 40 1760
22.  Isacord 40 0874
23.  Isacord 40 0015
24.  Isacord 40 0232
25.  Isacord 40 5832


























 **51211-16**  111 x 144 mm  
4.4 x 5.7 inch  8.230

1.  Isacord 40 0020
2.  Isacord 40 0020
3.  Isacord 40 0020
4.  Isacord 40 0015
5.  Isacord 40 2123







 **51211-04**  106 x 172 mm  
4.2 x 6.8 inch  18.131

1.  Isacord 40 0138
2.  Isacord 40 0138
3.  Isacord 40 0138
4.  Isacord 40 0138
5.  Isacord 40 0138
6.  Isacord 40 0138
7.  Isacord 40 0138
8.  Isacord 40 0138
9.  Isacord 40 0138
10.  Isacord 40 4174
11.  Isacord 40 0020
12.  Isacord 40 1972
13.  Isacord 40 0700
14.  Isacord 40 1904
15.  Isacord 40 2123
16.  Isacord 40 0184
17.  Isacord 40 1141
18.  Isacord 40 1252
19.  Isacord 40 6141
20.  Isacord 40 5833
21.  Isacord 40 5944
22.  Isacord 40 1760
23.  Isacord 40 0874





 **51266-06**  70 x 166 mm  
2.7 x 6.5 inch  13.036







1.  Isacord 40 0622
2.  Isacord 40 0622
3.  Isacord 40 0622
4.  Isacord 40 0520



<p><b>51252-03</b>  122 x 152 mm 4.8 x 6 inch  23.665</p>	<p><b>51252-07</b>  80 x 151 mm 3.2 x 5.9 inch  14.585</p>
<p>1.  Isacord 40 2152 2.  Isacord 40 0015 3.  Isacord 40 4430 4.  Isacord 40 0020 5.  Isacord 40 0702 6.  Isacord 40 2152</p> 	<p>1.  Isacord 40 4421 2.  Isacord 40 4430 3.  Isacord 40 2152 4.  Isacord 40 0702 5.  Isacord 40 0250 6.  Isacord 40 0015 7.  Isacord 40 0020</p> 
<p><b>51252-08</b>  97 x 154 mm 3.8 x 6.1 inch  21.693</p>	<p><b>51252-09</b>  98 x 160 mm 3.8 x 6.3 inch  20.912</p>
<p>1.  Isacord 40 2241 2.  Isacord 40 2152 3.  Isacord 40 0702 4.  Isacord 40 0250 5.  Isacord 40 0015 6.  Isacord 40 0020</p> 	<p>1.  Isacord 40 0020 2.  Isacord 40 0132 3.  Isacord 40 2152 4.  Isacord 40 0702 5.  Isacord 40 0250 6.  Isacord 40 0015 7.  Isacord 40 0020</p> 
<p><b>51252-10</b>  102 x 153 mm 4 x 6 inch  17.531</p>	<p><b>51252-11</b>  94 x 155 mm 3.7 x 6.1 inch  20.179</p>
<p>1.  Isacord 40 4421 2.  Isacord 40 4430 3.  Isacord 40 0702 4.  Isacord 40 0250 5.  Isacord 40 0015 6.  Isacord 40 0020</p> 	<p>1.  Isacord 40 2241 2.  Isacord 40 2152 3.  Isacord 40 0702 4.  Isacord 40 0250 5.  Isacord 40 0015 6.  Isacord 40 0020</p> 
<p><b>51252-12</b>  102 x 151 mm 4 x 5.9 inch  19.365</p>	<p><b>51252-13</b>  92 x 146 mm 3.6 x 5.7 inch  13.658</p>
<p>1.  Isacord 40 0020 2.  Isacord 40 0132 3.  Isacord 40 0702 4.  Isacord 40 0250 5.  Isacord 40 0015 6.  Isacord 40 0020</p> 	<p>1.  Isacord 40 4421 2.  Isacord 40 4430 3.  Isacord 40 0702 4.  Isacord 40 0250 5.  Isacord 40 0015 6.  Isacord 40 0020</p> 
<p><b>51252-14</b>  96 x 153 mm 3.8 x 6 inch  21.686</p>	<p><b>51252-15</b>  100 x 150 mm 3.9 x 5.9 inch  19.368</p>
<p>1.  Isacord 40 2241 2.  Isacord 40 2152 3.  Isacord 40 0702 4.  Isacord 40 0250 5.  Isacord 40 0015 6.  Isacord 40 0020</p> 	<p>1.  Isacord 40 0020 2.  Isacord 40 0132 3.  Isacord 40 4430 4.  Isacord 40 0702 5.  Isacord 40 0250 6.  Isacord 40 0015 7.  Isacord 40 0020</p> 




















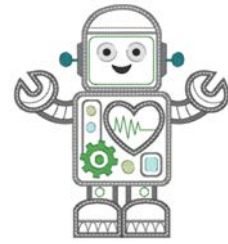
**51252-16**  95 x 151 mm  
3.7 x 5.9 inch  19.661


1.  Isacord 40 4421
2.  Isacord 40 4430
3.  Isacord 40 0702
4.  Isacord 40 0250
5.  Isacord 40 0015
6.  Isacord 40 0020









**12590-03**  135 x 147 mm  
5.3 x 5.8 inch  22.117



1.  Applique 1
2.  Applique 2
3.  Applique 1
4.  Applique 2
5.  Applique 1
6.  Applique 2
7.  Applique 1
8.  Applique 2
9.  Isacord 40 0015
10.  Isacord 40 0020
11.  Isacord 40 5510
12.  Isacord 40 5650
13.  Isacord 40 4230
14.  Isacord 40 4116
15.  Isacord 40 0132
16.  Isacord 40 0112
17.  Isacord 40 0015








**Cm031\_48**  86 x 64 mm  
3.4 x 2.5 inch  6.433



1.  Isacord 40 5730
2.  Isacord 40 1352
3.  Isacord 40 1755
4.  Isacord 40 1730
5.  Isacord 40 3820
6.  Isacord 40 3040











**Cm226\_48**  63 x 63 mm  
2.5 x 2.5 inch  6.214

1.  Isacord 40 0101
2.  Isacord 40 0131
3.  Isacord 40 0152
4.  Isacord 40 0020
5.  Isacord 40 1755















**Cm220\_48**  71 x 72 mm  
2.8 x 2.8 inch  7.571

1.  Isacord 40 1755
2.  Isacord 40 0101
3.  Isacord 40 0142
4.  Isacord 40 0101
5.  Isacord 40 4071
6.  Isacord 40 0142
7.  Isacord 40 0934
8.  Isacord 40 0020













**Be790305**  118 x 145 mm  
4.6 x 5.7 inch  13.118

1.  Isacord 40 0015
2.  Applique 1
3.  Applique 3
4.  Isacord 40 3541
5.  Applique 1
6.  Applique 3
7.  Isacord 40 0345
8.  Applique 1
9.  Applique 3
10.  Isacord 40 1900
11.  Isacord 40 0020
12.  Isacord 40 0015






**Be790307**  142 x 127 mm  
5.6 x 5 inch  19.667

1.  Applique 1
2.  Applique 3
3.  Isacord 40 3130
4.  Applique 1
5.  Applique 3
6.  Isacord 40 0003
7.  Isacord 40 1720
8.  Isacord 40 0020
9.  Isacord 40 0520
10.  Isacord 40 3541

















**Be790308**  155 x 178 mm  
6.1 x 7 inch  25.448

1.  Isacord 40 0020
2.  Applique 1
3.  Applique 2
4.  Isacord 40 1720














**Be790311**  114 x 152 mm  
4.5 x 6 inch  12.320

1.  Applique 1
2.  Applique 3
3.  Isacord 40 0933
4.  Applique 1
5.  Applique 3
6.  Applique 1
7.  Applique 3
8.  Isacord 40 0776
9.  Applique 1
10.  Applique 3
11.  Isacord 40 1900
12.  Isacord 40 0176
13.  Isacord 40 0015
14.  Isacord 40 0020




**Be790306**  132 x 151 mm  
5.2 x 6 inch  18.399

1.  Isacord 40 0003
2.  Applique 1
3.  Applique 2
4.  Isacord 40 0003
5.  Isacord 40 3910
6.  Isacord 40 0230
7.  Isacord 40 2723
8.  Isacord 40 1301
9.  Isacord 40 2640
10.  Isacord 40 0003
11.  Isacord 40 3332




**Be790309** 87 x 150 mm 3.4 x 5.9 inch 13.252

1. Applique 1
2. Applique 3
3. Isacord 40 0015
4. Isacord 40 1900
5. Isacord 40 0020
6. Isacord 40 4116
7. Isacord 40 0176
8. Isacord 40 0015
9. Isacord 40 0310




**Be790310** 138 x 136 mm 5.4 x 5.4 inch 16.278

1. Applique 1
2. Applique 3
3. Applique 1
4. Applique 3
5. Isacord 40 1161
6. Isacord 40 1141
7. Isacord 40 1161
8. Isacord 40 3654
9. Isacord 40 0176
10. Isacord 40 1141
11. Isacord 40 0020
12. Isacord 40 0015




**Be790312** 122 x 133 mm 4.8 x 5.2 inch 22.489

1. Applique 1
2. Applique 3
3. Applique 1
4. Applique 3
5. Isacord 40 0015
6. Isacord 40 1600
7. Isacord 40 0108
8. Isacord 40 2912
9. Isacord 40 3600
10. Isacord 40 1141
11. Isacord 40 0020



**Be790313** 99 x 102 mm 3.9 x 4 inch 8.788


1. Applique 1
2. Applique 3
3. Isacord 40 3750
4. Isacord 40 1114
5. Isacord 40 1900
6. Isacord 40 3620
7. Isacord 40 2510
8. Isacord 40 5324
9. Isacord 40 1114
10. Isacord 40 1060
11. Isacord 40 4114
12. Isacord 40 0020
13. Isacord 40 0015



## Animals


**51202-02** 114 x 145 mm 4.5 x 5.7 inch 12.428

1. Isacord 40 0010
2. Isacord 40 2762
3. Isacord 40 0182
4. Isacord 40 2776
5. Isacord 40 2152
6. Isacord 40 0020
7. Isacord 40 0310
8. Isacord 40 1755
9. Isacord 40 5770
10. Isacord 40 5822
11. Isacord 40 1911
12. Isacord 40 1921
13. Isacord 40 1430
14. Isacord 40 1532
15. Isacord 40 1362
16. Isacord 40 2153
17. Isacord 40 2152
18. Isacord 40 2155
19. Isacord 40 2171
20. Isacord 40 0010




**12375-04** 129 x 71 mm 5.1 x 2.8 inch 8.191

1. Isacord 40 0811
2. Isacord 40 0020
3. Isacord 40 3630
4. Isacord 40 5722




**12375-09** 158 x 217 mm 6.2 x 8.6 inch 18.055



1. Isacord 40 3251
2. Isacord 40 2532
3. Isacord 40 1906
4. Isacord 40 5722
5. Isacord 40 3630
6. Isacord 40 0811
7. Isacord 40 1304
8. Isacord 40 0105
9. Isacord 40 0020








**12454-14** 64 x 31 mm 2.5 x 1.2 inch 6.666



1. Isacord 40 3810
2. Yenmet 7037
3. Isacord 40 3732
4. Isacord 40 0020
5. Isacord 40 0015
6. Isacord 40 3810









**12824-03M**  144 x 150 mm  
5.7 x 5.9 inch  11.307



1.  Isacord 40 1134
2.  Isacord 40 0922
3.  Isacord 40 1172
4.  Isacord 40 0945











**12878-01**  141 x 112 mm  
5.6 x 4.4 inch  8.899



1.  Isacord 40 3852
2.  Isacord 40 1362
3.  Isacord 40 1030
4.  Isacord 40 4250
5.  Isacord 40 4430










**12910-03**  142 x 118 mm  
5.6 x 4.6 inch  18.848



1.  Isacord 40 0853
2.  Isacord 40 0870
3.  Isacord 40 0832
4.  Isacord 40 1755
5.  Isacord 40 2211
6.  Isacord 40 2153
7.  Isacord 40 1565





**51248-14L**  150 x 268 mm  
5.9 x 10.5 inch  8.496



1.  Isacord 40 2715
2.  Isacord 40 3902
3.  Isacord 40 0922
4.  Isacord 40 3630
5.  Isacord 40 2723
6.  Isacord 40 3645













**Wp380\_48**  80 x 116 mm  
3.2 x 4.6 inch  4.638



1.  Isacord 40 0020




























**Wp383\_48**  71 x 82 mm  
2.8 x 3.2 inch  13.891



1.  Isacord 40 0352
2.  Isacord 40 5833
3.  Isacord 40 0015
4.  Isacord 40 1874
5.  Isacord 40 0150
6.  Isacord 40 4174
7.  Isacord 40 0020
8.  Isacord 40 0015
9.  Isacord 40 4174














**Wp389\_48**  154 x 327 mm  
6.1 x 12.9 inch  53.330



1.  Isacord 40 5822
2.  Isacord 40 0651
3.  Isacord 40 0015
4.  Isacord 40 0842
5.  Isacord 40 1755
6.  Isacord 40 0853
7.  Isacord 40 1055
8.  Isacord 40 1233
9.  Isacord 40 1123
10.  Isacord 40 0945
11.  Isacord 40 0150
12.  Isacord 40 0111
13.  Isacord 40 1430
14.  Isacord 40 0020
15.  Isacord 40 0131
16.  Isacord 40 3971
17.  Isacord 40 2674
18.  Isacord 40 0111
19.  Isacord 40 0108
20.  Isacord 40 0132
21.  Isacord 40 4174
22.  Isacord 40 0020
23.  Isacord 40 0015
24.  Isacord 40 5833









**12791-01L**  203 x 241 mm  
8 x 9.5 inch  34.026



1.  Isacord 40 4174
2.  Isacord 40 0310
3.  Isacord 40 3910
4.  Isacord 40 2363
5.  Isacord 40 5515
6.  Isacord 40 0904
7.  Isacord 40 1940
8.  Isacord 40 2504
9.  Isacord 40 2520
10.  Isacord 40 4116












**12676-01**  81 x 148 mm  
3.2 x 5.8 inch  15.344

1.  Isacord 40 2171
2.  Isacord 40 2530
3.  Isacord 40 2155
4.  Isacord 40 2520
5.  Isacord 40 2500






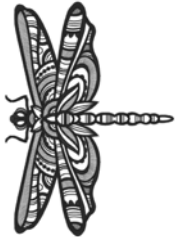



























**Cm263\_48**  116 x 192 mm  
4.6 x 7.6 inch  14.402


















1.  Isacord 40 3151
2.  Isacord 40 0532
3.  Isacord 40 1755
4.  Isacord 40 2171
5.  Isacord 40 2761
6.  Isacord 40 0015
7.  Isacord 40 0020
8.  Isacord 40 2155



# Overview Stitch Patterns


<b>12389-10</b>  53 x 45 mm 2.1 x 1.8 inch  2.784	<b>12760-02</b>  122 x 171 mm 4.8 x 6.7 inch  21.512
<ol style="list-style-type: none"> <li>Isacord 40 0020</li> <li>Yenmet 7003</li> <li>Isacord 40 0170</li> <li>Isacord 40 0811</li> <li>Isacord 40 0940</li> <li>Isacord 40 0800</li> <li>Isacord 40 0713</li> <li>Isacord 40 0933</li> <li>Isacord 40 0020</li> </ol> 	<ol style="list-style-type: none"> <li>Isacord 40 0020</li> </ol> 
<b>Wp415_48</b>  132 x 148 mm 5.2 x 5.8 inch  25.110	<b>Cm216_48</b>  47 x 67 mm 1.9 x 2.6 inch  5.046
<ol style="list-style-type: none"> <li>Isacord 40 0941</li> <li>Isacord 40 0532</li> <li>Isacord 40 0945</li> <li>Isacord 40 0020</li> </ol> 	<ol style="list-style-type: none"> <li>Isacord 40 1010</li> <li>Isacord 40 0101</li> <li>Isacord 40 0132</li> <li>Isacord 40 0020</li> <li>Isacord 40 0124</li> <li>Isacord 40 1010</li> <li>YLI variations 8012</li> </ol> 
 <b>Cm213_48</b>  58 x 102 mm 2.3 x 4 inch  7.866	<b>Wp421_48</b>  96 x 137 mm 3.8 x 5.4 inch  14.219
<ol style="list-style-type: none"> <li>Isacord 40 1840</li> <li>Isacord 40 1055</li> <li>Isacord 40 1252</li> <li>Isacord 40 0651</li> <li>Isacord 40 0660</li> <li>Isacord 40 0020</li> <li>Isacord 40 1055</li> </ol> 	<ol style="list-style-type: none"> <li>Isacord 40 1161</li> <li>Isacord 40 1876</li> <li>Isacord 40 1154</li> </ol> 
<b>Na248</b>  78 x 73 mm 3.1 x 2.9 inch  10.132	<b>Hd977</b>  98 x 98 mm 3.8 x 3.9 inch  13.738
<ol style="list-style-type: none"> <li>Isacord 40 0101</li> <li>Isacord 40 3971</li> <li>Isacord 40 2220</li> <li>Isacord 40 0132</li> <li>Isacord 40 2051</li> <li>Isacord 40 2155</li> <li>Isacord 40 2320</li> <li>Isacord 40 2220</li> <li>Yenmet 7023</li> </ol> 	<ol style="list-style-type: none"> <li>Isacord 40 3962</li> <li>Isacord 40 0015</li> <li>Isacord 40 0640</li> <li>Isacord 40 0824</li> <li>Isacord 40 2650</li> <li>Isacord 40 0020</li> <li>Isacord 40 0142</li> <li>Isacord 40 0640</li> <li>Isacord 40 0824</li> <li>Isacord 40 2650</li> <li>Isacord 40 2830</li> <li>Isacord 40 1352</li> <li>Yenmet 7029</li> </ol> 
<b>Lj598</b>  106 x 81 mm 4.2 x 3.2 inch  15.746	<b>51274-05</b>  82 x 177 mm 3.2 x 7 inch  28.909
<ol style="list-style-type: none"> <li>Isacord 40 0101</li> <li>Isacord 40 0131</li> <li>Isacord 40 0132</li> <li>Isacord 40 4174</li> <li>Isacord 40 0108</li> <li>Isacord 40 0020</li> <li>Isacord 40 5933</li> <li>Isacord 40 0453</li> </ol> 	<ol style="list-style-type: none"> <li>Isacord 40 2170</li> <li>Isacord 40 1860</li> <li>Isacord 40 2051</li> <li>Isacord 40 0010</li> <li>Isacord 40 0761</li> <li>Isacord 40 1123</li> <li>Isacord 40 2051</li> <li>Isacord 40 1543</li> <li>Isacord 40 4174</li> <li>Isacord 40 0020</li> <li>Isacord 40 0853</li> <li>Isacord 40 0945</li> <li>Isacord 40 4174</li> <li>Isacord 40 0010</li> </ol> 

**51274-04**  89 x 140 mm  
3.5 x 5.5 inch  33.260

- 1.  Isacord 40 2170
- 2.  Isacord 40 1860
- 3.  Isacord 40 2051
- 4.  Isacord 40 0761
- 5.  Isacord 40 1123
- 6.  Isacord 40 0853
- 7.  Isacord 40 1134
- 8.  Isacord 40 0945
- 9.  Isacord 40 0010
- 10.  Isacord 40 5542
- 11.  Isacord 40 0020
- 12.  Isacord 40 1375
- 13.  Isacord 40 2051
- 14.  Isacord 40 1123
- 15.  Isacord 40 4174
- 16.  Isacord 40 0020
- 17.  Isacord 40 0108
- 18.  Isacord 40 0010



**Borders and Lace**

 **12742-01**  137 x 133 mm  
5.4 x 5.2 inch  41.668



- 1.  Isacord 40 1911



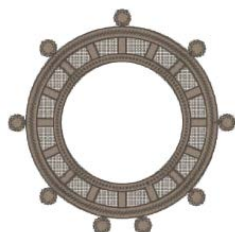
 **12779-02**  87 x 210 mm  
3.4 x 8.3 inch  63.342



- 1.  Isacord 40 1874



 **12779-05**  76 x 75 mm  
3 x 2.9 inch  8.875



- 1.  Isacord 40 1874







**12837-02**  229 x 229 mm  
9 x 9 inch  21.284

- 1.  Isacord 40 5912



 **12889-09**  133 x 224 mm  
5.3 x 8.8 inch  51.499

- 1.  Isacord 40 0017
- 2.  Isacord 40 3652
- 3.  Isacord 40 2650
- 4.  Isacord 40 3030





 **12896-05**  116 x 117 mm  
4.6 x 4.6 inch  32.525

- 1.  Isacord 40 0781





**82011-30**  107 x 130 mm  
4.2 x 5.1 inch  17.281

- 1.  Isacord 40 0660
- 2.  Yenmet 7013













































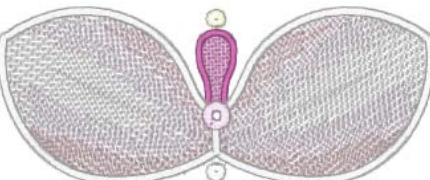





























**82011-28**  134 x 99 mm  
5.3 x 3.9 inch  23.505


- 1.  Isacord 40 0660
- 2.  Yenmet 7013





# Overview Stitch Patterns



<b>Nb952_48</b>	 108 x 119 mm 4.3 x 4.7 inch	 22.514	 <b>Oc00303</b>	 101 x 110 mm 4 x 4.4 inch	 35.018
<ol style="list-style-type: none"> <li>1.  Isacord 40 0020</li> <li>2.  Isacord 40 4174</li> <li>3.  Isacord 40 0020</li> <li>4.  Isacord 40 4174</li> <li>5.  Isacord 40 0761</li> </ol>		<ol style="list-style-type: none"> <li>1. Isacord 40 0015</li> </ol>			
 <b>12410-08</b>	 80 x 168 mm 3.2 x 6.6 inch	 22.500	 <b>12410-07</b>	 115 x 158 mm 4.5 x 6.2 inch	 30.450
<ol style="list-style-type: none"> <li>1.  Isacord 40 1874</li> </ol>		<ol style="list-style-type: none"> <li>1.  Isacord 40 1874</li> </ol>			
 <b>12410-15</b>	 29 x 133 mm 1.1 x 5.3 inch	 9.439	 <b>12454-05</b>	 117 x 108 mm 4.6 x 4.3 inch	 17.499
<ol style="list-style-type: none"> <li>1.  Isacord 40 4752</li> </ol>		<ol style="list-style-type: none"> <li>1. Isacord 40 0015</li> <li>2.  Isacord 40 2650</li> <li>3.  Isacord 40 2155</li> <li>4. Isacord 40 0015</li> </ol>			
 <b>12454-06</b>	 117 x 48 mm 4.6 x 1.9 inch	 11.296	 <b>12454-07</b>	 48 x 57 mm 1.9 x 2.3 inch	 6.491
<ol style="list-style-type: none"> <li>1.  Isacord 40 0250</li> <li>2.  Isacord 40 2508</li> <li>3. Isacord 40 0015</li> <li>4.  Isacord 40 2650</li> <li>5.  Isacord 40 2155</li> <li>6. Isacord 40 0015</li> <li>7.  Isacord 40 2650</li> </ol>		<ol style="list-style-type: none"> <li>1. Isacord 40 0015</li> <li>2.  Isacord 40 2650</li> <li>3.  Isacord 40 2508</li> <li>4.  Isacord 40 2155</li> <li>5.  Isacord 40 2650</li> </ol>			
 <b>12398-29</b>	 26 x 153 mm 1 x 6 inch	 13.035	 <b>12398-30</b>	 77 x 77 mm 3 x 3 inch	 12.150
<ol style="list-style-type: none"> <li>1.  Isacord 40 1351</li> </ol>		<ol style="list-style-type: none"> <li>1.  Isacord 40 1351</li> </ol>			
 <b>12659-01</b>	 45 x 58 mm 1.8 x 2.3 inch	 6.790	 <b>12659-06</b>	 37 x 59 mm 1.4 x 2.3 inch	 6.465
<ol style="list-style-type: none"> <li>1.  Isacord 40 1352</li> <li>2.  Isacord 40 1430</li> </ol>		<ol style="list-style-type: none"> <li>1.  Isacord 40 4625</li> <li>2.  Isacord 40 4515</li> </ol>			

**21021-25**  34 x 71 mm  
1.3 x 2.8 inch  4.748

1.  Isacord 40 1252




**12766-08**  86 x 139 mm  
3.4 x 5.5 inch  18.797

1. Isacord 40 0017  
2. Isacord 40 0017  
3. Isacord 40 0017  
4. Isacord 40 0017  
5.  Yenmet 7005  
6.  Isacord 40 1903





## Mini

**12373-08**  16 x 16 mm  
0.6 x 0.6 inch  232

1.  Isacord 40 0776






**12418-27**  13 x 25 mm  
0.5 x 1 inch  339



1.  Isacord 40 5822  
2.  Isacord 40 2250



**12422-31**  32 x 40 mm  
1.3 x 1.6 inch  2.539

1.  Isacord 40 1114  
2.  Isacord 40 1311  
3.  Isacord 40 0811






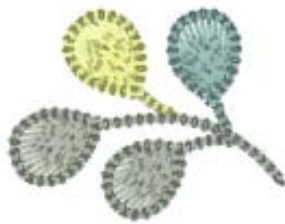
**12428-26**  22 x 28 mm  
0.9 x 1.1 inch  377

1. Isacord 40 0015






**12508-12**  44 x 34 mm  
1.8 x 1.3 inch  1.789

1.  Isacord 40 4752  
2.  Isacord 40 0352  
3.  Isacord 40 5552






**12508-21**  46 x 60 mm  
1.8 x 2.4 inch  2.629



1.  Isacord 40 6133  
2.  Isacord 40 4752  
3.  Isacord 40 5552






**12508-30**  46 x 58 mm  
1.8 x 2.3 inch  1.662














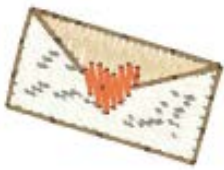





















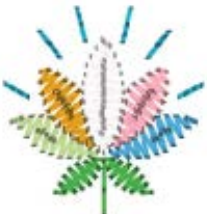











































1.  Isacord 40 0124  
2.  Isacord 40 0352  
3.  Isacord 40 6133




























































**12819-02**  33 x 30 mm  
1.3 x 1.2 inch  1.588

1.  Isacord 40 4071  
2. Isacord 40 0015  
3.  Isacord 40 0800  
4.  Isacord 40 0020



















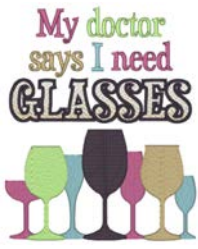

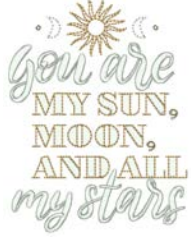
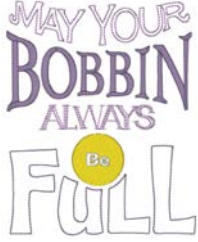





<p><b>12819-04</b>  30 x 37 mm 1.2 x 1.5 inch  1.396</p>	<p><b>12819-06</b>  34 x 25 mm 1.4 x 1 inch  914</p>
<p>1.  Isacord 40 0020 2.  Isacord 40 2530 3.  Isacord 40 0800 4.  Isacord 40 0131</p> 	<p>1.  Isacord 40 0970 2.  Isacord 40 0771 3.  Isacord 40 0945 4.  Isacord 40 1725</p> 
<p><b>12819-14</b>  31 x 30 mm 1.2 x 1.2 inch  999</p> <p>1. Isacord 40 0015 2.  Isacord 40 2530 3.  Isacord 40 6141 4.  Isacord 40 0020</p> 	<p><b>12819-17</b>  32 x 34 mm 1.3 x 1.4 inch  1.277</p> <p>1.  Isacord 40 3830 2.  Isacord 40 3730 3.  Isacord 40 5531</p> 
<p><b>12822-06</b>  34 x 36 mm 1.3 x 1.4 inch  1.083</p> <p>1.  Isacord 40 5510 2.  Isacord 40 5822 3.  Isacord 40 3901 4.  Isacord 40 2152 5.  Isacord 40 0904 6.  Isacord 40 2171 7.  Isacord 40 4114</p> 	<p><b>12822-07</b>  32 x 38 mm 1.3 x 1.5 inch  1.781</p> <p>1.  Isacord 40 3901 2.  Isacord 40 5822 3.  Isacord 40 4114 4. Isacord 40 0015</p> 
<p><b>12822-13</b>  28 x 28 mm 1.1 x 1.1 inch  909</p> <p>1.  Isacord 40 2155 2.  Isacord 40 2152 3.  Isacord 40 3901 4. Isacord 40 0015 5.  Isacord 40 6043</p> 	<p><b>12836-35</b>  45 x 46 mm 1.8 x 1.8 inch  2.190</p> <p>1.  Isacord 40 1900 2.  Isacord 40 2011 3.  Isacord 40 5833 4. Isacord 40 0010</p> 
<p><b>12903-07</b>  21 x 45 mm 0.8 x 1.8 inch  741</p> <p>1.  Isacord 40 4740 2.  Isacord 40 5115 3.  Isacord 40 3150</p> 	<p><b>51204-22</b>  23 x 27 mm 0.9 x 1.1 inch  971</p> <p>1.  Isacord 40 2723</p> 
<p><b>51215-18</b>  30 x 29 mm 1.2 x 1.1 inch  994</p> <p>1.  Isacord 40 6011 2.  Isacord 40 1904 3.  Isacord 40 5912 4.  Isacord 40 5633</p> 	<p><b>51253-07</b>  24 x 42 mm 0.9 x 1.7 inch  1.008</p> <p>1.  Isacord 40 0506 2.  Isacord 40 2160 3.  Isacord 40 2530 4.  Isacord 40 2520</p> 



<b>51253-08</b>  26 x 41 mm 1 x 1.6 inch  937	<b>51253-13</b>  34 x 33 mm 1.4 x 1.3 inch  1.471
<ol style="list-style-type: none"> <li>1.  Isacord 40 0741</li> <li>2.  Isacord 40 0506</li> <li>3.  Isacord 40 0520</li> </ol> 	<ol style="list-style-type: none"> <li>1.  Isacord 40 0670</li> <li>2.  Isacord 40 0506</li> <li>3.  Isacord 40 1030</li> <li>4.  Isacord 40 4174</li> <li>5.  Isacord 40 2520</li> </ol> 
<b>51253-20</b>  26 x 24 mm 1 x 0.9 inch  816	<b>82006-17</b>  35 x 37 mm 1.4 x 1.4 inch  3.133
<ol style="list-style-type: none"> <li>1.  Isacord 40 0506</li> <li>2.  Isacord 40 1030</li> <li>3.  Isacord 40 0741</li> </ol> 	<ol style="list-style-type: none"> <li>1.  Isacord 40 0660</li> <li>2.  Isacord 40 0832</li> <li>3.  Isacord 40 1526</li> <li>4.  Isacord 40 4421</li> <li>5.  Isacord 40 4174</li> </ol> 
<b>82015-23</b>  54 x 54 mm 2.1 x 2.1 inch  2.980	<b>Cj587</b>  24 x 33 mm 0.9 x 1.3 inch  1.919
<ol style="list-style-type: none"> <li>1.  Isacord 40 2152</li> <li>2.  Isacord 40 0874</li> <li>3.  Isacord 40 0532</li> <li>4.  Isacord 40 0453</li> </ol> 	<ol style="list-style-type: none"> <li>1.  Isacord 40 2171</li> <li>2.  Isacord 40 1840</li> <li>3.  Isacord 40 5610</li> </ol> 
<b>Nv104</b>  34 x 31 mm 1.4 x 1.2 inch  1.854	<b>Oc86069</b>  18 x 21 mm 0.7 x 0.8 inch  441
<ol style="list-style-type: none"> <li>1.  Isacord 40 3600</li> <li>2.  Isacord 40 0015</li> <li>3.  Isacord 40 1902</li> </ol> 	<ol style="list-style-type: none"> <li>1.  Isacord 40 3962</li> <li>2.  Isacord 40 3641</li> </ol> 
<b>Oc86074</b>  15 x 15 mm 0.6 x 0.6 inch  359	
<ol style="list-style-type: none"> <li>1.  Isacord 40 2155</li> <li>2.  Isacord 40 2764</li> </ol> 	

## Sayings

<b>51284-06</b>  114 x 83 mm 4.5 x 3.3 inch  7.428	<b>12738-01</b>  126 x 121 mm 5 x 4.8 inch  16.138
<ol style="list-style-type: none"> <li>1.  Isacord 40 1114</li> <li>2.  Isacord 40 0221</li> <li>3.  Isacord 40 6043</li> <li>4.  Isacord 40 4643</li> <li>5.  Isacord 40 0221</li> </ol> 	<ol style="list-style-type: none"> <li>1.  Isacord 40 4152</li> <li>2.  Isacord 40 0643</li> <li>3.  Isacord 40 5610</li> <li>4.  Isacord 40 2500</li> <li>5.  Isacord 40 2944</li> </ol> 

<p><b>12738-03</b></p>	<p>113 x 139 mm 4.4 x 5.5 inch</p> <p>25.182</p>	<p><b>12913-10L</b></p> <p>127 x 178 mm 5 x 7 inch</p> <p>3.929</p>
<p>1. Isacord 40 2500 2. Isacord 40 4152 3. Isacord 40 0643 4. Isacord 40 0015 5. Isacord 40 2944 6. Isacord 40 5610</p>		<p>1. Isacord 40 0015 2. Isacord 40 0132 3. Isacord 40 0832 4. Isacord 40 4423 5. Isacord 40 1600 6. Isacord 40 0132</p> 
<p><b>51248-12S</b></p>	<p>110 x 171 mm 4.4 x 6.7 inch</p> <p>9.750</p>	<p><b>51278-05</b></p> <p>100 x 131 mm 3.9 x 5.1 inch</p> <p>10.789</p>
<p>1. Isacord 40 3902 2. Isacord 40 3630 3. Isacord 40 3630 4. Isacord 40 2723 5. Isacord 40 3902 6. Isacord 40 2715 7. Isacord 40 0922 8. Isacord 40 3645</p>		<p>1. Isacord 40 1260 2. Isacord 40 0731</p> 
<p><b>12449-02</b></p>	<p>112 x 139 mm 4.4 x 5.5 inch</p> <p>8.357</p>	<p><b>51300-01</b></p> <p>127 x 155 mm 5 x 6.1 inch</p> <p>12.912</p>
<p>1. Isacord 40 2920 2. Isacord 40 0504 3. Isacord 40 0015 4. Isacord 40 2830</p>		<p>1. Isacord 40 4740 2. Isacord 40 1362 3. Isacord 40 0520 4. Isacord 40 1860 5. Isacord 40 2550 6. Isacord 40 2508 7. Isacord 40 4531 8. Isacord 40 1220 9. Isacord 40 0704 10. Isacord 40 1753 11. Isacord 40 4220</p> 
<p><b>12473-06</b></p>	<p>133 x 120 mm 5.3 x 4.7 inch</p> <p>11.358</p>	<p><b>51300-02</b></p> <p>135 x 155 mm 5.3 x 6.1 inch</p> <p>13.846</p>
<p>1. Isacord 40 4610 2. Isacord 40 5633</p>		<p>1. Isacord 40 4740 2. Isacord 40 1220 3. Isacord 40 4220 4. Isacord 40 0520 5. Isacord 40 1753 6. Isacord 40 0704 7. Isacord 40 0015 8. Isacord 40 2550 9. Isacord 40 2508 10. Isacord 40 4531</p> 
<p><b>51300-04</b></p>	<p>106 x 173 mm 4.2 x 6.8 inch</p> <p>12.911</p>	<p><b>51300-10</b></p> <p>110 x 147 mm 4.3 x 5.8 inch</p> <p>8.359</p>
<p>1. Isacord 40 4740 2. Isacord 40 2550 3. Isacord 40 1362 4. Isacord 40 1220 5. Isacord 40 2508 6. Isacord 40 4220 7. Isacord 40 4531</p>		<p>1. Isacord 40 1362 2. Isacord 40 1220 3. Isacord 40 2550 4. Isacord 40 2508 5. Isacord 40 4740 6. Isacord 40 4220 7. Isacord 40 0520 8. Isacord 40 0704 9. Isacord 40 4531</p> 

**51300-11** 131 x 136 mm  
5.1 x 5.4 inch 16.730

1. Isacord 40 4220
2. Isacord 40 2550
3. Isacord 40 0520
4. Isacord 40 2508
5. Isacord 40 1362
6. Isacord 40 4740
7. Isacord 40 4531
8. Isacord 40 1860
9. Isacord 40 1753

**19999-002** 125 x 136 mm  
4.9 x 5.4 inch 10.184

1. Isacord 40 0015
2. Isacord 40 0015
3. Isacord 40 0015

**Nb934\_48** 132 x 165 mm  
5.2 x 6.5 inch 9.168

1. Isacord 40 2241
2. Isacord 40 1154
3. Isacord 40 1346
4. Isacord 40 1161
5. Isacord 40 2222
6. Isacord 40 5833
7. Isacord 40 1154
8. Isacord 40 2241

**Nb935\_48** 104 x 169 mm  
4.1 x 6.6 inch 10.171

1. Isacord 40 2222
2. Isacord 40 1346
3. Isacord 40 0232
4. Isacord 40 1154
5. Isacord 40 5833
6. Isacord 40 2241

**12490-03** 118 x 113 mm  
4.6 x 4.5 inch 6.669

1. Isacord 40 0108
2. Isacord 40 3641
3. Isacord 40 3652

**12490-04** 146 x 122 mm  
5.8 x 4.8 inch 8.724

1. Isacord 40 0108
2. Isacord 40 3641
3. Isacord 40 3652

**12490-05** 126 x 104 mm  
4.9 x 4.1 inch 6.148

1. Isacord 40 0108
2. Isacord 40 3641
3. Isacord 40 3652














































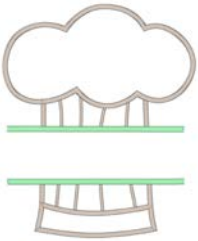


































**51209-02** 171 x 196 mm  
6.7 x 7.7 inch 43.385

1. Isacord 40 0020
2. Isacord 40 4410
3. Isacord 40 4643
4. Isacord 40 4610
5. Isacord 40 3030
6. Isacord 40 3150
7. Isacord 40 2920
8. Isacord 40 0020
9. Isacord 40 0010
10. Isacord 40 0608
11. Isacord 40 0904
12. Isacord 40 1321
13. Isacord 40 1912
14. Isacord 40 1902
15. Isacord 40 1725
16. Isacord 40 0020
17. Isacord 40 0010

**51209-04** 146 x 216 mm  
5.7 x 8.5 inch 56.779

1. Isacord 40 0020
2. Isacord 40 4643
3. Isacord 40 4410
4. Isacord 40 4610
5. Isacord 40 4643
6. Isacord 40 0182
7. Isacord 40 0020
8. Isacord 40 0608
9. Isacord 40 0904
10. Isacord 40 1321
11. Isacord 40 1912
12. Isacord 40 1902
13. Isacord 40 1725
14. Isacord 40 0020
15. Isacord 40 0010

## Sport and Hobbies

<p><b>12796-03L</b>  194 x 278 mm 7.6 x 10.9 inch  31.215</p>	<p><b>12800-055</b>  123 x 150 mm 4.8 x 5.9 inch  11.476</p>
<p>1.  Isacord 40 1904</p> 	<p>1. Isacord 40 0015</p> 
<p><b>51217-05L</b>  159 x 210 mm 6.3 x 8.3 inch  28.887</p>	<p><b>12932-07</b>  127 x 178 mm 5 x 7 inch  13.885</p>
<p>1.  Isacord 40 3040 2.  Isacord 40 0842 3.  Isacord 40 0660 4.  Isacord 40 0853 5.  Isacord 40 0138 6.  Isacord 40 3971 7.  Isacord 40 2250 8.  Isacord 40 0020</p> 	<p>1.  Isacord 40 1010 2.  Isacord 40 1010 3.  Isacord 40 0101 4.  Isacord 40 1921 5.  Isacord 40 1921 6.  Isacord 40 0101</p> 
<p> <b>12611-08</b>  80 x 120 mm 3.1 x 4.7 inch  5.770</p>	<p> <b>12611-18</b>  130 x 158 mm 5.1 x 6.2 inch  8.045</p>
<p>1.  Applique 1 2.  Applique 2 3.  Applique 1 4.  Applique 2 5.  Isacord 40 1154 6.  Isacord 40 5440 7.  Isacord 40 1902</p> 	<p>1.  Applique 1 2.  Applique 2 3.  Isacord 40 0151 4.  Isacord 40 5440</p> 
<p> <b>82014-28</b>  142 x 117 mm 5.6 x 4.6 inch  26.582</p>	<p><b>Be790606</b>  100 x 86 mm 3.9 x 3.4 inch  7.445</p>
<p>1.  Applique 1 2.  Applique 2 3.  Isacord 40 0105 4.  Isacord 40 0020 5.  Isacord 40 4073 6.  Isacord 40 1902</p> 	<p>1.  Isacord 40 0020 2.  Isacord 40 1306</p> 
<p><b>Be790603</b>  80 x 75 mm 3.2 x 2.9 inch  11.824</p>	<p> <b>12472-01</b>  138 x 142 mm 5.4 x 5.6 inch  23.233</p>
<p>1. Isacord 40 0015 2.  Isacord 40 3654</p> 	<p>1.  Isacord 40 2504 2.  Isacord 40 3901 3.  Isacord 40 5610 4.  Isacord 40 4240 5. Isacord 40 0015 6. Isacord 40 0015 7.  Isacord 40 1123 8.  Isacord 40 0761 9.  Isacord 40 1902 10.  Isacord 40 2504 11.  Isacord 40 3901 12.  Isacord 40 5610 14.  Isacord 40 1300</p> 

**Be790608** 80 x 80 mm  
3.2 x 3.1 inch 7.937

1. Isacord 40 0020



**Nx737** 72 x 99 mm  
2.8 x 3.9 inch 10.793

1. Isacord 40 0015
2. Yenmet 7005
3. Isacord 40 3962
4. Isacord 40 0020



**Nx741** 80 x 78 mm  
3.1 x 3.1 inch 11.206

1. Isacord 40 0131
2. Isacord 40 0111
3. Isacord 40 0970
4. Isacord 40 0015
5. Isacord 40 3971
6. Yenmet 7009
7. Yenmet 7003
8. Isacord 40 4230
9. Isacord 40 4174



**12383-18** 91 x 171 mm  
3.6 x 6.7 inch 5.182

1. Isacord 40 4174



**Be790602** 80 x 75 mm  
3.1 x 3 inch 10.169

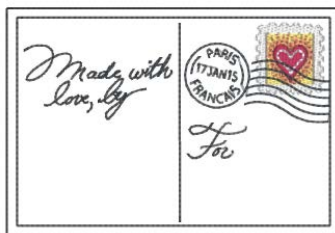
1. Isacord 40 5643
2. Isacord 40 5912
3. Isacord 40 0015



## Hoop

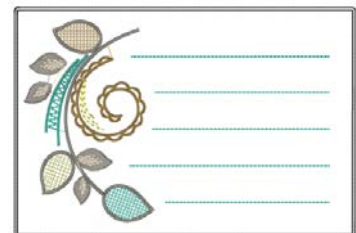
**12383-09** 113 x 77 mm  
4.4 x 3 inch 4.757

1. Isacord 40 0020
2. Isacord 40 4174
3. Isacord 40 0608
4. Isacord 40 2101
5. Isacord 40 1600
6. Isacord 40 0015
7. Isacord 40 4174



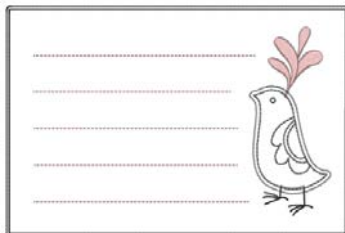
**12621-19** 155 x 104 mm  
6.1 x 4.1 inch 8.360

1. Isacord 40 0015
2. Isacord 40 0015
3. Isacord 40 0721
4. Isacord 40 4620
5. Isacord 40 0352
6. Isacord 40 0152
7. Isacord 40 0672
8. Isacord 40 4620
9. Isacord 40 0015



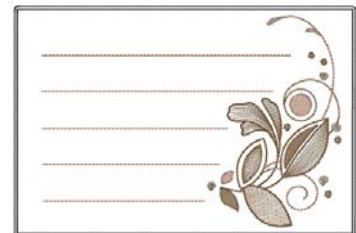
**12621-04** 155 x 104 mm  
6.1 x 4.1 inch 3.803

1. Isacord 40 0015
2. Isacord 40 0015
3. Isacord 40 0020
4. Isacord 40 2051
5. Isacord 40 0015
6. Isacord 40 4174
7. Isacord 40 2051
8. Isacord 40 0015



**12621-05** 155 x 104 mm  
6.1 x 4.1 inch 5.811

1. Isacord 40 0015
2. Isacord 40 0015
3. Isacord 40 0933
4. Isacord 40 1252
5. Isacord 40 1252
6. Isacord 40 0015



Overview Stitch Patterns

**12621-09** 155 x 104 mm 6.1 x 4.1 inch 5.520

1. Isacord 40 0015
2. Isacord 40 0015
3. Isacord 40 0504
4. Isacord 40 0542
5. Isacord 40 0542
6. Isacord 40 0015

**12621-02** 155 x 104 mm 6.1 x 4.1 inch 5.558

1. Isacord 40 0020
2. Isacord 40 0020
3. Isacord 40 0811
4. Isacord 40 4952
5. Isacord 40 1921
6. Isacord 40 4952
7. Isacord 40 0020

**80090-26** 124 x 129 mm 4.9 x 5.1 inch 6.087

1. Applique 1
2. Applique 2
3. Applique 1
4. Applique 2
5. Isacord 40 4103
6. Isacord 40 2508

**12611-27** 137 x 137 mm 5.4 x 5.4 inch 3.961

1. Applique 1
2. Applique 2
3. Isacord 40 5440

**12611-28** 140 x 140 mm 5.5 x 5.5 inch 3.649

1. Applique 1
2. Applique 2
3. Isacord 40 0703

**12649-05** 91 x 88 mm 3.6 x 3.5 inch 9.087

1. Applique 1
2. Applique 2
3. Isacord 40 1840
4. Isacord 40 1860
5. Isacord 40 0015

**12606-26** 139 x 139 mm 5.5 x 5.5 inch 5.211

1. Isacord 40 0670
2. Isacord 40 0670
3. Isacord 40 0670

**12606-33** 43 x 70 mm 1.7 x 2.8 inch 2.376

1. Isacord 40 0670
2. Isacord 40 0670
3. Isacord 40 0670

**12606-37** 46 x 78 mm 1.8 x 3.1 inch 2.692

1. Isacord 40 0670
2. Isacord 40 0670
3. Isacord 40 0670

**12611-21** 72 x 156 mm 2.8 x 6.1 inch 11.513

1. Applique 1
2. Applique 2
3. Isacord 40 1703

**12611-23** 72 x 156 mm 2.8 x 6.1 inch 12.817

1. Applique 1
2. Applique 2
3. Isacord 40 1902

**12611-22** 72 x 156 mm 2.8 x 6.1 inch 12.504

1. Applique 1
2. Applique 2
3. Isacord 40 1703

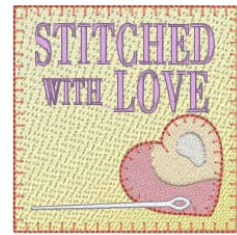
**12611-24** 72 x 156 mm 2.8 x 6.1 inch 12.613

1. Applique 1
2. Applique 2
3. Isacord 40 1902



**Nz195** 77 x 77 mm 3 x 3 inch 15.343

1. Isacord 40 0660
2. Isacord 40 0713
3. Isacord 40 2153
4. Isacord 40 1362
5. Isacord 40 0870
6. Isacord 40 2830
7. Isacord 40 1725
8. Isacord 40 4071



**Nx763** 87 x 72 mm 3.4 x 2.8 inch 14.953

1. Isacord 40 2155
2. Isacord 40 0520
3. Isacord 40 1921
4. Isacord 40 5912
5. Isacord 40 5510
6. Isacord 40 3040
7. Isacord 40 0310
8. Isacord 40 3910
9. Isacord 40 0442
10. Isacord 40 2830



## Seasons

**Hd300** 91 x 99 mm 3.6 x 3.9 inch 13.754

1. Isacord 40 0015
2. Isacord 40 3901
3. Isacord 40 0015
4. Isacord 40 3650
5. Isacord 40 3901
6. Isacord 40 0250
7. Isacord 40 2830
8. Isacord 40 3743
9. Isacord 40 0800
10. Isacord 40 1902
11. Isacord 40 0853
12. Isacord 40 3600
13. Isacord 40 1430
14. Isacord 40 5531
15. Isacord 40 0811
16. Isacord 40 0660
17. Isacord 40 4174
18. Yenmet 7029



**12417-10** 113 x 136 mm 4.5 x 5.4 inch 8.635

1. Isacord 40 0811
2. Isacord 40 0721
3. Isacord 40 1032
4. Isacord 40 0345



**12629-18** 67 x 91 mm 2.6 x 3.6 inch 5.944



1. Isacord 40 4220
2. Isacord 40 4220
3. Isacord 40 4220
4. Isacord 40 4220
5. Isacord 40 4220
6. Isacord 40 4421
7. Isacord 40 0015
8. Isacord 40 4240




**12677-03** 148 x 104 mm 5.8 x 4.1 inch 7.927



1. Isacord 40 0108
2. Isacord 40 0108
3. Isacord 40 0108
4. Isacord 40 0108
5. Isacord 40 0108
6. Isacord 40 0108
7. Isacord 40 0108
8. Isacord 40 0108
9. Isacord 40 0108
10. Isacord 40 5050
11. Isacord 40 1010
12. Isacord 40 1332
13. Isacord 40 4610
14. Isacord 40 0132















**12796-04L**  204 x 259 mm  
8 x 10.2 inch  18.337

1.  Isacord 40 1904











**12836-12**  112 x 165 mm  
4.4 x 6.5 inch  18.687

1.  Isacord 40 1161  
2.  Isacord 40 5833  
3.  Isacord 40 5643  
4.  Isacord 40 2011  
5.  Isacord 40 2152  
6.  Isacord 40 1900  
7.  Isacord 40 5643  
8.  Isacord 40 5833  
9.  Isacord 40 0453  
10.  Isacord 40 5832  
11.  Isacord 40 0010  
12.  Isacord 40 3963










11. Isacord 40 0010 12. Isacord 40 3963

**12836-17**  107 x 134 mm  
4.2 x 5.3 inch  17.387



1.  Isacord 40 1761  
2.  Isacord 40 2051  
3.  Isacord 40 0020  
4.  Isacord 40 1900  
5.  Isacord 40 2011  
6.  Isacord 40 0010  
7.  Isacord 40 0142  
8.  Isacord 40 2011









**12861-09L**  178 x 253 mm  
7 x 10 inch  32.697



1.  Isacord 40 0640  
2.  Isacord 40 1030  
3.  Isacord 40 2640  
4.  Isacord 40 1840  
5.  Isacord 40 0506  
6.  Isacord 40 1102  
7.  Isacord 40 2721



































**12895-02L**  127 x 178 mm  
5 x 7 inch  7.610


















1.  Isacord 40 0010  
2.  Isacord 40 3730  
3.  Isacord 40 5440  
4.  Isacord 40 5210  
5.  Isacord 40 5740  
6.  Isacord 40 4174













**51211-15**  135 x 153 mm  
5.3 x 6 inch  31.240

1.  Isacord 40 2123  
2.  Isacord 40 2123  
3.  Isacord 40 2123  
4.  Isacord 40 2123  
5.  Isacord 40 2123  
6.  Isacord 40 2123  
7.  Isacord 40 2123  
8.  Isacord 40 2123  
9.  Isacord 40 2123  
10.  Isacord 40 5832  
11.  Isacord 40 0352  
12.  Isacord 40 4074  
13.  Isacord 40 4174  
14.  Isacord 40 0020  
15.  Isacord 40 0700  
16.  Isacord 40 1760  
17.  Isacord 40 3815  
18.  Isacord 40 6141  
19.  Isacord 40 5833  
20.  Isacord 40 4122  
21.  Isacord 40 0015  
22.  Isacord 40 3732  
23.  Isacord 40 4101  
24.  Isacord 40 1904  
25.  Isacord 40 5832  
26.  Isacord 40 0640  
27.  Isacord 40 2115  
28.  Isacord 40 0184  
29.  Isacord 40 5944  
30.  Isacord 40 1760  
31.  Isacord 40 0874  
32.  Isacord 40 0142





11.  Isacord 40 0352 12.  Isacord 40 4074  
14.  Isacord 40 0020 15.  Isacord 40 0700  
17.  Isacord 40 3815 18.  Isacord 40 6141  
19.  Isacord 40 5833 21.  Isacord 40 0015  
22.  Isacord 40 3732 24.  Isacord 40 1904  
25.  Isacord 40 5832 27.  Isacord 40 2115  
26.  Isacord 40 0640 30.  Isacord 40 1760  
28.  Isacord 40 0184 32.  Isacord 40 0142  
29.  Isacord 40 5944








**51216-11**  114 x 170 mm  
4.5 x 6.7 inch  19.771

1.  Isacord 40 3971  
2.  Isacord 40 5050  
3.  Isacord 40 1532  
4.  Isacord 40 0020  
5.  Isacord 40 2155  
6.  Isacord 40 2300  
7.  Isacord 40 5115  
8.  Isacord 40 2711  
9.  Isacord 40 1753  
10.  Isacord 40 2300



11. Isacord 40 0015 12.  Isacord 40 1840

**51252-02**  97 x 125 mm  
3.8 x 4.9 inch  24.063


1.  Isacord 40 2152  
2.  Isacord 40 0015  
3.  Isacord 40 4430  
4.  Isacord 40 2152  
5.  Isacord 40 0015  
6.  Isacord 40 0702  
7.  Isacord 40 0020






**51270-04** 125 x 207 mm  
4.9 x 8.1 inch 16.828

1. Isacord 40 4740
2. Isacord 40 2155
3. Isacord 40 5115
4. Isacord 40 4740
5. Isacord 40 0904
6. Isacord 40 1730
7. Isacord 40 0506
8. Isacord 40 0520
9. Isacord 40 0138




**51287-06** 76 x 103 mm  
3 x 4.1 inch 4.474

1. Isacord 40 3644
2. Isacord 40 3910
3. Isacord 40 3114
4. Isacord 40 2732
5. Isacord 40 0345
6. Isacord 40 0501




**82031-24** 123 x 119 mm  
4.8 x 4.7 inch 23.676

1. Isacord 40 5050
2. Isacord 40 0015
3. Isacord 40 0622
4. Isacord 40 1321
5. Isacord 40 1114
6. Isacord 40 2171
7. Isacord 40 3444
8. Isacord 40 1753
9. Isacord 40 2171




**Cm547\_48** 97 x 122 mm  
3.8 x 4.8 inch 18.516

1. Isacord 40 0182
2. Isacord 40 0015
3. Isacord 40 5531
4. Isacord 40 0142
5. Isacord 40 6031
6. Isacord 40 0108
7. Isacord 40 5101
8. Isacord 40 6011
9. Isacord 40 4122
10. Isacord 40 4103
11. Isacord 40 0111
12. Yenmet 7030
13. Isacord 40 3902
14. Isacord 40 0020




**Hg298\_48** 65 x 112 mm  
2.6 x 4.4 inch 1.878

1. Isacord 40 2101




**Nb768\_48** 125 x 113 mm  
4.9 x 4.4 inch 7.109

1. Isacord 40 0651
2. Yenmet 7037



**82023-14** 119 x 123 mm  
4.7 x 4.8 inch 14.989

1. Isacord 40 1753
2. Isacord 40 1753
3. Isacord 40 1753
4. Isacord 40 0010
5. Isacord 40 5100
6. Isacord 40 5210
7. Isacord 40 5220
8. Isacord 40 2101
9. Isacord 40 1753




**82023-15** 124 x 152 mm  
4.9 x 6 inch 9.577

1. Isacord 40 5210
2. Isacord 40 5220
3. Isacord 40 5100
4. Isacord 40 1805
5. Isacord 40 2101
6. Isacord 40 1753




**82023-13** 106 x 156 mm  
4.2 x 6.1 inch 11.315

1. Isacord 40 5220
2. Isacord 40 1753
3. Isacord 40 1805
4. Isacord 40 2101
5. Isacord 40 5210
6. Isacord 40 5100



**Hg795\_48** 89 x 164 mm  
3.5 x 6.5 inch 3.453

1. Isacord 40 5730
2. Isacord 40 5513
3. Isacord 40 4430
4. Isacord 40 1032
5. Isacord 40 1900
6. Isacord 40 4113



Overview Stitch Patterns

**12597-16** 88 x 85 mm  
3.5 x 3.3 inch 15.862

1. Isacord 40 0904
2. Isacord 40 0940



**12858-04** 159 x 164 mm  
6.3 x 6.4 inch 16.385

1. Isacord 40 0015
2. Isacord 40 0015



**80009-17** 86 x 130 mm  
3.4 x 5.1 inch 6.582

1. Isacord 40 5934
2. Isacord 40 5866
3. Isacord 40 5934



**He255** 133 x 127 mm  
5.2 x 5 inch 17.198

1. Isacord 40 0111
2. Isacord 40 1701
3. Isacord 40 1800
4. Isacord 40 1701
5. Isacord 40 1800
6. Isacord 40 2640
7. Isacord 40 5650
8. Isacord 40 5610
9. Isacord 40 0015
10. Isacord 40 0111
11. Isacord 40 1060
12. Isacord 40 3910
13. Isacord 40 0800
14. Isacord 40 0940
15. Isacord 40 0651
16. Isacord 40 0832
17. Isacord 40 0651
18. Isacord 40 0832
19. Isacord 40 3650
20. Isacord 40 1351
21. Isacord 40 0108



**He252** 88 x 145 mm  
3.5 x 5.7 inch 12.251

1. Isacord 40 1902
2. Isacord 40 1701
3. Isacord 40 1902
4. Isacord 40 0532
5. Isacord 40 0842
6. Isacord 40 0532
7. Isacord 40 0842
8. Isacord 40 1902
9. Isacord 40 0651
10. Isacord 40 1123
11. Isacord 40 5220
12. Isacord 40 5210
13. Isacord 40 5422
14. Isacord 40 0101
15. Isacord 40 1430
16. Isacord 40 1725
17. Isacord 40 0520
18. Isacord 40 0824
19. Isacord 40 3910
20. Isacord 40 3650
21. Isacord 40 3910
22. Isacord 40 1902
23. Isacord 40 3650
24. Isacord 40 1123
25. Isacord 40 5324
26. Isacord 40 1154



**Hg746\_48** 112 x 138 mm  
4.4 x 5.4 inch 17.815

1. Isacord 40 3040
2. Applique 1
3. Applique 2
4. Isacord 40 0221
5. Applique 1
6. Applique 2
7. Isacord 40 0142
8. Isacord 40 0108
9. Applique 1
10. Applique 2
11. Isacord 40 0800
12. Isacord 40 0020
13. Isacord 40 1200
14. Isacord 40 0020
15. Isacord 40 0670



**Rc514** 74 x 99 mm  
2.9 x 3.9 inch 15.603

1. Isacord 40 1172
2. Isacord 40 0842
3. Isacord 40 0651
4. Isacord 40 0821
5. Isacord 40 0941
6. Isacord 40 0101
7. Isacord 40 0640
8. Isacord 40 3910
9. Isacord 40 4103
10. Isacord 40 3522
11. Isacord 40 0842









**Hg747\_48** 124 x 147 mm  
4.9 x 5.8 inch 18.378


1. Isacord 40 0970
2. Isacord 40 3770
3. Isacord 40 5912
4. Isacord 40 0520
5. Isacord 40 0811
6. Isacord 40 3350
7. Isacord 40 3040
8. Applique 1
9. Applique 2
10. Applique 1
11. Applique 2
12. Applique 1
13. Applique 2
14. Isacord 40 4073
15. Isacord 40 0020
16. Isacord 40 1200
17. Isacord 40 0101



<b>Hg806_48</b>	 28 x 170 mm 1.1 x 6.7 inch	 4.988	<b>12415-32</b>	 80 x 191 mm 3.1 x 7.5 inch	 10.937
-----------------	---	---	-----------------	---	--


1.  Isacord 40 2530
2.  Isacord 40 1900
3.  Isacord 40 5730
4.  Isacord 40 1114
5.  Isacord 40 4430
6.  Isacord 40 4113

Let it Snow



1.  YLI variations 8019

YLI

<b>12415-29</b>	 108 x 172 mm 4.3 x 6.8 inch	 4.814	<b>12655-14</b>	 164 x 110 mm 6.4 x 4.4 inch	 16.122
-----------------	--	---	-----------------	--	--






1.  YLI variations 8019









1.  Isacord 40 1115
2.  Isacord 40 1055

Give Thanks

<b>12861-02L</b>	 190 x 219 mm 7.5 x 8.6 inch	 24.122	<b>51248-02L</b>	 197 x 206 mm 7.7 x 8.1 inch	 17.453
------------------	--	--	------------------	--	--

1.  Isacord 40 2640
2.  Isacord 40 2721
3.  Isacord 40 3815
4.  Isacord 40 3962
5.  Isacord 40 2721



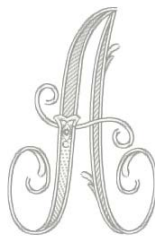
1.  Isacord 40 3902
2.  Isacord 40 3630
3.  Isacord 40 2723
4.  Isacord 40 3902
5.  Isacord 40 3630
6.  Isacord 40 2715

I'M Snow CUTE

### Charming monograms

<b>12587-01</b>	 59 x 90 mm 2.3 x 3.5 inch	 6.471	<b>12587-02</b>	 52 x 90 mm 2.1 x 3.5 inch	 6.938
-----------------	--	---	-----------------	--	---

1.  Isacord 40 0101



1.  Isacord 40 0101



<b>12587-03</b>	 45 x 90 mm 1.8 x 3.5 inch	 4.591	<b>12587-04</b>	 57 x 90 mm 2.2 x 3.6 inch	 6.580
-----------------	--	---	-----------------	--	---








































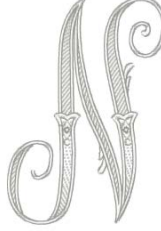








1.  Isacord 40 0101



1.  Isacord 40 0101



Overview Stitch Patterns

<b>12587-05</b>  50 x 90 mm 2 x 3.6 inch  5.643	<b>12587-06</b>  57 x 90 mm 2.2 x 3.5 inch  5.439
1.  Isacord 40 0101 	1.  Isacord 40 0101 
<b>12587-07</b>  39 x 90 mm 1.5 x 3.6 inch  5.200	<b>12587-08</b>  62 x 90 mm 2.4 x 3.6 inch  7.850
1.  Isacord 40 0101 	1.  Isacord 40 0101 
<b>12587-09</b>  49 x 89 mm 1.9 x 3.5 inch  4.990	<b>12587-10</b>  57 x 89 mm 2.2 x 3.5 inch  6.021
1.  Isacord 40 0101 	1.  Isacord 40 0101 
<b>12587-11</b>  62 x 91 mm 2.4 x 3.6 inch  7.067	<b>12587-12</b>  63 x 90 mm 2.5 x 3.5 inch  5.116
1.  Isacord 40 0101 	1.  Isacord 40 0101 
<b>12587-13</b>  64 x 92 mm 2.5 x 3.6 inch  7.776	<b>12587-14</b>  63 x 90 mm 2.5 x 3.6 inch  7.400
1.  Isacord 40 0101 	1.  Isacord 40 0101 
<b>12587-15</b>  44 x 90 mm 1.7 x 3.5 inch  5.783	<b>12587-16</b>  63 x 89 mm 2.5 x 3.5 inch  7.336
1.  Isacord 40 0101 	1.  Isacord 40 0101 



<b>12587-17</b>	 54 x 89 mm 2.1 x 3.5 inch	 6.583	<b>12587-18</b>	 64 x 90 mm 2.5 x 3.6 inch	 7.491
-----------------	--	---	-----------------	--	---

1. Isacord 40 0101



1. Isacord 40 0101



<b>12587-19</b>	 56 x 90 mm 2.2 x 3.6 inch	 5.705	<b>12587-20</b>	 57 x 90 mm 2.2 x 3.5 inch	 5.318
-----------------	--	---	-----------------	--	---

1. Isacord 40 0101



1. Isacord 40 0101



<b>12587-21</b>	 62 x 91 mm 2.4 x 3.6 inch	 6.137	<b>12587-22</b>	 64 x 91 mm 2.5 x 3.6 inch	 5.277
-----------------	--	---	-----------------	--	---

1. Isacord 40 0101



1. Isacord 40 0101

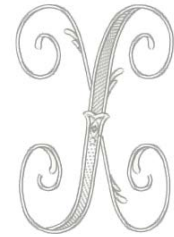


<b>12587-23</b>	 64 x 90 mm 2.5 x 3.6 inch	 7.519	<b>12587-24</b>	 62 x 91 mm 2.4 x 3.6 inch	 5.684
-----------------	--	---	-----------------	--	---

1. Isacord 40 0101



1. Isacord 40 0101



<b>12587-25</b>	 52 x 91 mm 2 x 3.6 inch	 5.979	<b>12587-26</b>	 68 x 89 mm 2.7 x 3.5 inch	 5.047
-----------------	--	---	-----------------	--	---

1. Isacord 40 0101



1. Isacord 40 0101



<b>12587-53</b>	 67 x 23 mm 2.6 x 0.9 inch	 994	<b>12587-54</b>	 50 x 107 mm 2 x 4.2 inch	 3.910
-----------------	--	---	-----------------	---	---

1. Isacord 40 0101















1. Isacord 40 0101








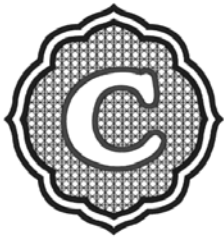











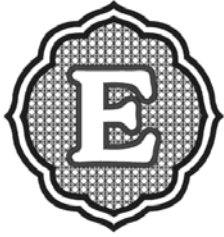























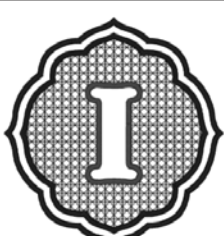



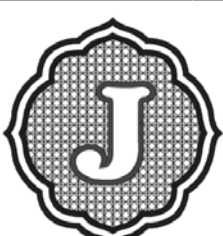







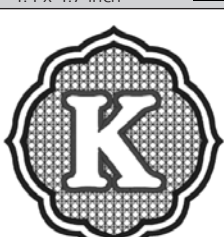



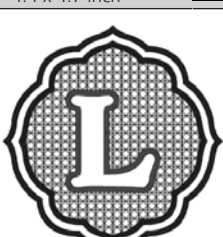







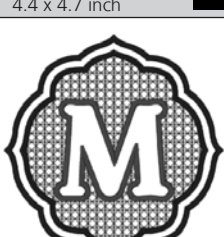













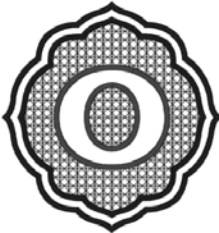



























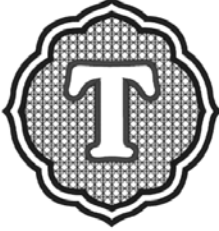




































Overview Stitch Patterns

<b>12587-55</b>  70 x 144 mm 2.8 x 5.7 inch  7.108	<b>12587-56</b>  49 x 100 mm 1.9 x 3.9 inch  3.819
1.  Isacord 40 0101 	1.  Isacord 40 0101 
<b>12587-57</b>  57 x 20 mm 2.3 x 0.8 inch  1.459	<b>12587-58</b>  53 x 116 mm 2.1 x 4.6 inch  3.614
1.  Isacord 40 0101 	1.  Isacord 40 0101 
<b>12587-59</b>  33 x 94 mm 1.3 x 3.7 inch  2.321	<b>12587-60</b>  126 x 126 mm 5 x 5 inch  5.003
1.  Isacord 40 0101 	1.  Isacord 40 0101 
<b>12587-61</b>  36 x 29 mm 1.4 x 1.1 inch  2.091	<b>12587-62</b>  35 x 34 mm 1.4 x 1.3 inch  2.284
1.  Isacord 40 0101 	1.  Isacord 40 0101 

Modern Monograms


<b>12863-01</b>  113 x 119 mm 4.4 x 4.7 inch  10.297	<b>12863-02</b>  113 x 119 mm 4.4 x 4.7 inch  10.441
1.  Isacord 40 0020 2.  Isacord 40 0020 3.  Isacord 40 0020 	1.  Isacord 40 0020 2.  Isacord 40 0020 3.  Isacord 40 0020 



<b>12863-03</b>  113 x 119 mm 4.4 x 4.7 inch  10.224	<b>12863-04</b>  113 x 119 mm 4.4 x 4.7 inch  10.360
1.  Isacord 40 0020 2.  Isacord 40 0020 3.  Isacord 40 0020 	1.  Isacord 40 0020 2.  Isacord 40 0020 3.  Isacord 40 0020 
<b>12863-05</b>  113 x 119 mm 4.4 x 4.7 inch  10.658	<b>12863-06</b>  113 x 119 mm 4.4 x 4.7 inch  10.414
1.  Isacord 40 0020 2.  Isacord 40 0020 3.  Isacord 40 0020 	1.  Isacord 40 0020 2.  Isacord 40 0020 3.  Isacord 40 0020 
<b>12863-07</b>  113 x 119 mm 4.4 x 4.7 inch  10.430	<b>12863-08</b>  113 x 119 mm 4.4 x 4.7 inch  10.741
1.  Isacord 40 0020 2.  Isacord 40 0020 3.  Isacord 40 0020 	1.  Isacord 40 0020 2.  Isacord 40 0020 3.  Isacord 40 0020 
<b>12863-09</b>  113 x 119 mm 4.4 x 4.7 inch  9.720	<b>12863-10</b>  113 x 119 mm 4.4 x 4.7 inch  9.836
1.  Isacord 40 0020 2.  Isacord 40 0020 3.  Isacord 40 0020 	1.  Isacord 40 0020 2.  Isacord 40 0020 3.  Isacord 40 0020 
<b>12863-11</b>  113 x 119 mm 4.4 x 4.7 inch  10.644	<b>12863-12</b>  113 x 119 mm 4.4 x 4.7 inch  10.019
1.  Isacord 40 0020 2.  Isacord 40 0020 3.  Isacord 40 0020 	1.  Isacord 40 0020 2.  Isacord 40 0020 3.  Isacord 40 0020 
<b>12863-13</b>  113 x 119 mm 4.4 x 4.7 inch  10.896	<b>12863-14</b>  113 x 119 mm 4.4 x 4.7 inch  10.622
1.  Isacord 40 0020 2.  Isacord 40 0020 3.  Isacord 40 0020 	1.  Isacord 40 0020 2.  Isacord 40 0020 3.  Isacord 40 0020 


<p><b>12863-15</b>  113 x 119 mm 4.4 x 4.7 inch  10.168</p>	<p><b>12863-16</b>  113 x 119 mm 4.4 x 4.7 inch  10.539</p>
<p>1.  Isacord 40 0020 2.  Isacord 40 0020 3.  Isacord 40 0020</p> 	<p>1.  Isacord 40 0020 2.  Isacord 40 0020 3.  Isacord 40 0020</p> 
<p><b>12863-17</b>  113 x 119 mm 4.4 x 4.7 inch  10.476</p>	<p><b>12863-18</b>  113 x 119 mm 4.4 x 4.7 inch  10.769</p>
<p>1.  Isacord 40 0020 2.  Isacord 40 0020 3.  Isacord 40 0020</p> 	<p>1.  Isacord 40 0020 2.  Isacord 40 0020 3.  Isacord 40 0020</p> 
<p><b>12863-19</b>  113 x 119 mm 4.4 x 4.7 inch  10.410</p>	<p><b>12863-20</b>  113 x 119 mm 4.4 x 4.7 inch  10.167</p>
<p>1.  Isacord 40 0020 2.  Isacord 40 0020 3.  Isacord 40 0020</p> 	<p>1.  Isacord 40 0020 2.  Isacord 40 0020 3.  Isacord 40 0020</p> 
<p><b>12863-21</b>  113 x 119 mm 4.4 x 4.7 inch  10.410</p>	<p><b>12863-22</b>  113 x 119 mm 4.4 x 4.7 inch  10.169</p>
<p>1.  Isacord 40 0020 2.  Isacord 40 0020 3.  Isacord 40 0020</p> 	<p>1.  Isacord 40 0020 2.  Isacord 40 0020 3.  Isacord 40 0020</p> 
<p><b>12863-23</b>  113 x 119 mm 4.4 x 4.7 inch  10.738</p>	<p><b>12863-24</b>  113 x 119 mm 4.4 x 4.7 inch  10.728</p>
<p>1.  Isacord 40 0020 2.  Isacord 40 0020 3.  Isacord 40 0020</p> 	<p>1.  Isacord 40 0020 2.  Isacord 40 0020 3.  Isacord 40 0020</p> 
<p><b>12863-25</b>  113 x 119 mm 4.4 x 4.7 inch  10.206</p>	<p><b>12863-26</b>  113 x 119 mm 4.4 x 4.7 inch  10.367</p>
<p>1.  Isacord 40 0020 2.  Isacord 40 0020 3.  Isacord 40 0020</p> 	<p>1.  Isacord 40 0020 2.  Isacord 40 0020 3.  Isacord 40 0020</p> 








<p><b>12877-07</b>  24 x 58 mm 0.9 x 2.3 inch  800</p>	<p><b>12877-08</b>  16 x 62 mm 0.6 x 2.5 inch  1.046</p>
<p>1.  Isacord 40 0020</p> 	<p>1.  Isacord 40 0020</p> 
<p><b>12877-09</b>  12 x 56 mm 0.5 x 2.2 inch  598</p>	<p><b>12877-10</b>  21 x 60 mm 0.8 x 2.4 inch  664</p>
<p>1.  Isacord 40 0020</p> 	<p>1.  Isacord 40 0020</p> 
<p><b>12877-11</b>  32 x 62 mm 1.2 x 2.4 inch  1.081</p>	<p><b>12877-12</b>  20 x 64 mm 0.8 x 2.5 inch  630</p>
<p>1.  Isacord 40 0020</p> 	<p>1.  Isacord 40 0020</p> 
<p><b>12877-13</b>  43 x 62 mm 1.7 x 2.4 inch  1.672</p>	<p><b>12877-14</b>  34 x 62 mm 1.4 x 2.4 inch  1.296</p>
<p>1.  Isacord 40 0020</p> 	<p>1.  Isacord 40 0020</p> 
<p><b>12877-15</b>  27 x 56 mm 1.1 x 2.2 inch  1.164</p>	<p><b>12877-16</b>  30 x 57 mm 1.2 x 2.3 inch  1.116</p>
<p>1.  Isacord 40 0020</p> 	<p>1.  Isacord 40 0020</p> 
<p><b>12877-17</b>  27 x 62 mm 1.1 x 2.4 inch  1.455</p>	<p><b>12877-18</b>  33 x 62 mm 1.3 x 2.4 inch  1.367</p>
<p>1.  Isacord 40 0020</p> 	<p>1.  Isacord 40 0020</p> 

**12877-19**  23 x 66 mm  
0.9 x 2.6 inch  1.059

1.  Isacord 40 0020




**12877-20**  34 x 63 mm  
1.3 x 2.5 inch  709

1.  Isacord 40 0020




**12877-21**  29 x 62 mm  
1.1 x 2.4 inch  1.279

1.  Isacord 40 0020




**12877-22**  19 x 69 mm  
0.8 x 2.7 inch  981



1.  Isacord 40 0020



**12877-23**  38 x 70 mm  
1.5 x 2.8 inch  1.393

1.  Isacord 40 0020




**12877-24**  42 x 76 mm  
1.7 x 3 inch  1.120



1.  Isacord 40 0020



**12877-25**  22 x 60 mm  
0.9 x 2.4 inch  1.084

1.  Isacord 40 0020




**12877-26**  27 x 60 mm  
1.1 x 2.4 inch  932

1.  Isacord 40 0020



**12877-27**  15 x 22 mm  
0.6 x 0.9 inch  505


1.  Isacord 40 0020




**12877-28**  13 x 64 mm  
0.5 x 2.5 inch  883



1.  Isacord 40 0020



**12877-29**  14 x 17 mm  
0.6 x 0.7 inch  325

1.  Isacord 40 0020





**12877-30**  23 x 78 mm  
0.9 x 3.1 inch  1.221

1.  Isacord 40 0020



Overview Stitch Patterns

**12877-31**  8 x 19 mm  
0.3 x 0.7 inch  320

1.  Isacord 40 0020

e

**12877-32**  18 x 74 mm  
0.7 x 2.9 inch  991

1.  Isacord 40 0020

f

**12877-33**  14 x 53 mm  
0.5 x 2.1 inch  710

1.  Isacord 40 0020

g

**12877-34**  21 x 61 mm  
0.8 x 2.4 inch  799


1.  Isacord 40 0020

h

**12877-36**  4 x 39 mm  
0.2 x 1.5 inch  306

1.  Isacord 40 0020

i

**12877-35**  12 x 65 mm  
0.5 x 2.6 inch  530



1.  Isacord 40 0020


j

**12877-37**  11 x 65 mm  
0.4 x 2.6 inch  738



1.  Isacord 40 0020

k

**12877-38**  14 x 71 mm  
0.6 x 2.8 inch  839



1.  Isacord 40 0020

l

**12877-39**  22 x 35 mm  
0.9 x 1.4 inch  655

1.  Isacord 40 0020

m

**12877-40**  14 x 23 mm  
0.6 x 0.9 inch  340



1.  Isacord 40 0020

n

**12877-41**  14 x 19 mm  
0.6 x 0.8 inch  340

1.  Isacord 40 0020


o


**12877-42**  20 x 51 mm  
0.8 x 2 inch  822

1.  Isacord 40 0020


p



**12877-43**  13 x 56 mm  
0.5 x 2.2 inch  789

1.  Isacord 40 0020




**12877-44**  11 x 21 mm  
0.4 x 0.8 inch  294

1.  Isacord 40 0020



**12877-45**  15 x 37 mm  
0.6 x 1.5 inch  626


1.  Isacord 40 0020




**12877-46**  18 x 53 mm  
0.7 x 2.1 inch  569

1.  Isacord 40 0020



**12877-47**  18 x 20 mm  
0.7 x 0.8 inch  491



1.  Isacord 40 0020




**12877-48**  11 x 20 mm  
0.4 x 0.8 inch  327

1.  Isacord 40 0020



**12877-49**  28 x 33 mm  
1.1 x 1.3 inch  658

1.  Isacord 40 0020




**12877-50**  29 x 40 mm  
1.1 x 1.6 inch  589

1.  Isacord 40 0020



**12877-51**  19 x 53 mm  
0.7 x 2.1 inch  713

1.  Isacord 40 0020


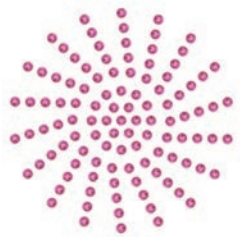




































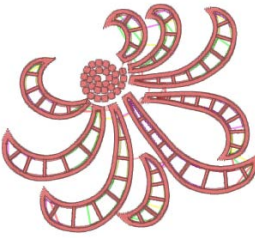









**12877-52**  14 x 54 mm  
0.5 x 2.1 inch  592

1.  Isacord 40 0020





## DesignWorks

<p><b>Dw11</b> 70 x 71 mm 2.8 x 2.8 inch 110</p>	<p><b>Be790901</b> 182 x 252 mm 7.1 x 9.9 inch 38.392</p>
<p>1.  Swarovski 0502</p> 	<p>1.  Edding 34 2.  Edding 9 3.  Edding 33 4.  Edding 68 5.  Edding 1</p> 
<p><b>Be790903</b> 181 x 293 mm 7.1 x 11.5 inch 11.366</p>	<p><b>Be790905</b> 104 x 227 mm 4.1 x 8.9 inch 21.349</p>
<p>1.  Edding 19</p> 	<p>1.  Edding 34 2.  Edding 12 3.  Edding 16 4.  Edding 10 5.  Edding 1</p> 
<p><b>Be790906</b> 192 x 196 mm 7.6 x 7.7 inch 21.054</p>	<p><b>Be790909</b> 167 x 322 mm 6.6 x 12.7 inch 20.162</p>
<p>1.  Edding 8 2.  Edding 3 3.  Edding 5 4.  Edding 34 5.  Edding 69 6.  Edding 10 7.  Edding 5 8.  Edding 9 9.  Edding 11 10.  Edding 65 11.  Edding 12</p> 	<p>1.  Edding 7</p> 
<p><b>Dw07</b> 114 x 152 mm 4.5 x 6 inch 198</p>	<p><b>Dw05</b> 105 x 94 mm 4.1 x 3.7 inch 13.334</p>
<p>1.  Swarovski 0237</p> 	<p>1.  Isacord 40 2022 2.  Cut 0001 3.  Cut 0002 4.  Cut 0003 5.  Cut 0004 6.  Isacord 40 2022</p> 
<p><b>Dw10</b> 119 x 119 mm 4.7 x 4.7 inch 5.939</p>	<p><b>Dw08</b> 206 x 100 mm 8.1 x 3.9 inch 424</p>
<p>1.  Cut 0001 2.  Cut 0002 3.  Cut 0003 4.  Cut 0004</p> 	<p>1.  Swarovski 0501</p> 

**Be700121**

196 x 197 mm  
7.7 x 7.8 inch

2.183

- 1.  Isacord 40 3600
- 2.  Isacord 40 1703



**Be700122**

119 x 37 mm  
4.7 x 1.5 inch

4.124



- 1.  Isacord 40 5833



**Be700123**

113 x 206 mm  
4.4 x 8.1 inch

6.090



- 1.  Punch 0004
- 2.  Punch 0007



**Be700124**

141 x 134 mm  
5.6 x 5.3 inch

6.184

- 1.  Isacord 40 2300
- 2.  Isacord 40 3901



## Index

### A

Activate/Deactivate Functions.....	28
Adjust Values.....	28
Adjusting the Presser Foot Position via the Knee Lifter of the Free Hand System.....	40
Adjusting the Thread Cut.....	54
Adjusting the Upper Thread Tension .....	51
Alphabets .....	108
Altering size of monogram.....	110
Altering the Embroidery Design Size Disproportionally.....	150
Altering the Embroidery Design Size Proportionally .....	150
Altering the Stitch Density.....	152
Attaching the Hoop .....	143
Attaching the Knee Lifter of the Free Hand System .....	36
Attaching the Module.....	136
Attaching the Stitch Plate.....	139

### B

BERNINA Dual Feed.....	65
Activating/Deactivating .....	66
Buttonholes .....	111

### C

Calibrating the Buttonhole Foot with Slide #3A.....	61
Calibrating the Display .....	60
Calibrating the Embroidery Hoop.....	56
Calling up the Creative Consultant.....	64
Calling up the Embroidery Consultant.....	64
Calling Up the Help.....	64
Calling up the Tutorial .....	64
Changing the Needle.....	42
Changing the Presser Foot .....	40
Changing the Stitch Plate.....	44
Checking the firmware version.....	177
Child safety lock .....	64
Cleaning the Feed Dog .....	178
Cleaning the Hook.....	179
Combination Mode.....	71
Combining Embroidery Designs .....	159
Cord.....	114
Creating Lettering.....	164

### D

Decorative Stitches .....	100
Display machine ID .....	62
Dispose of the Machine .....	191

### E

Editing lettering	
multi-line .....	165
single-line .....	165
Embroidery File Format .....	133
Embroidery Test.....	133
Energy-saving Mode .....	64
Entering dealer data .....	62
Environmental Protection.....	13
Error Messages .....	182
Explanation of Symbols.....	14

### F

Firmware	
Activate/Deactivate Functions.....	28
Adjust Values .....	28
Navigation .....	27
Fit.....	159
Fitting the Embroidery Needle.....	138
Foot Control .....	37
Connecting .....	35
Free Point Positioning .....	157

### I

Inserting the Spool Cap .....	38
-------------------------------	----

### L

Laser.....	44, 140
Lubricating the Hook .....	179

### M

Machine Name .....	63
Maintenance and Cleaning .....	178
Morph .....	158
Moving the hoop to the Back .....	144
Moving the Module for the Sewing Mode .....	144

### N

Navigation .....	27
Needle Stop Up/Down (Permanent).....	43







BERNINA recommends threads from *Mettler*<sup>®</sup>

BERNINA International AG | CH-8266 Steckborn Switzerland | [www.bernina.com](http://www.bernina.com) | © Copyright by BERNINA International AG

1072895.00A.04  
2023-03 EN

made to create **BERNINA**